



Product Overview

PRODUCT OVERVIEW



WE CARE TO CONNECT

1. Pipes

	6
A. STANDARD (PE-XC/AL/PE-XC)	7
B. RIXC (PE-XC/AL/PE-XC)	14
C. FLOOR-RIXC (PE-XC/AL/PE-XC)	19
D. PE-XC	20
E. PE-RT	21
F. PROTECTION HOSE	22
G. GAS STANDARD (PE-XC/AL/PE-XC)	23
H. SPRINKLER STANDARD (PE-XC/AL/PE-XC)	24

2. Henco Press

	25
A. HENCO PRESS PK	26
B. HENCO PRESS WHITE PKW	38
C. HENCO PRESS GAS PKG	46
D. HENCO PRESS SUPERSIZES	53
E. HENCO ECOLINE	64

3. Henco Vision	65
A. VISION FITTINGS	65
B. MANIFOLDS	72
4. Brass Press Fittings	73
A. PRESS FITTINGS	74
B. PRESS FITTINGS GAS	88
5. Brass Compression Fittings	93
6. Manifolds	100
A. FULL FLOW MANIFOLD	101
B. BRASS MANIFOLDS	106
7. Valves	110
A. INOX VALVES	111
B. BRASS VALVES	112
8. Underfloor Heatings	114
A. SYSTEMS	115
B. MANIFOLDS	122
C. HENCOLOGIC WIRED	131
D. HENCOLOGIC WIRELESS	132
9. Underfloor Heating Cabinets	137
10. Tools	139
A. BENDING TOOLS	140
B. CUTTING TOOLS	141
C. CALIBRATION TOOLS	143
D. PRESSING TOOLS	145
E. UNDERFLOOR HEATING TOOLS	158
11. Accessoires	159
12. Henco Sprinkler	163
A. SPRINKLER STANDARD (PE-XC/AL/PE-XC)	164
B. HENCO PRESS SPRINKLER	165
C. HENCO PRO-SPRINKLER	171
D. SPRINKLER TOOLS	175
Certificates	176
Index	178

ABOUT HENCO & SUSTAINABILITY



Sustainability, also our concern

Sustainability is an important concept at Henco. Apart from offering sustainable solutions, such as underfloor heating, we also want to operate sustainably as a company. This implies taking the 3 P's into account: people, planet and profit.

To us, corporate sustainability means paying attention to these three pillars by taking a variety of actions internally. For instance, it is important to deal sustainably with internal employees, to conduct a correct environmental policy and to use our profits wisely.

Henco products enable the following Sustainable Development Goals:



Henco is committed to be net zero carbon by 2050. Therefore, we measure, manage and monitor both our energy consumption and our CO2 emissions. It is Henco's objective to decrease its CO2 intensity for scope 1 and 2 with 70% by 2030, taking 2019 as a base year,

	Focus	Projects	2026	2030	Net zero carbon 2050
Scope 1 + 2	Energy use (in CO ₂ intensity)	<ul style="list-style-type: none"> • Drive energy efficiency • Use renewable energy 	Target 30% versus 2019	Target 70% versus 2019	
Scope 3	Raw materials, waste, travel, transport, end of life	<ul style="list-style-type: none"> • Reduce, reuse, recycle • Travel consciously • Perform life cycle and circular design assessments 	Target 10% versus 2019	Target 23% versus 2019	



ISO14001 certified

All the effort we put into environmental matters resulted in Henco getting through the certification audits for ISO14001. After 3 days of audits on various business processes, we achieved a very positive audit result without any recorded remarks. The auditor praised, among other things, the enthusiasm of our employees and the broad demonstration of sustainability throughout our processes.



A silver medal from Ecovadis

The online platform Ecovadis rates companies on their Corporate Social Responsibility (CSR) performance. They look at various issues such as environmental efforts, human and labour rights, sustainable procurement and business ethics. Henco's efforts in these areas were rewarded with a silver Ecovadis medal. As Henco puts its money where its mouth is, Ecovadis places Henco among the 19% best scoring companies. And we are quite proud of that



Aalberts Sustainability Award 2021

Aalberts also saw that we at Henco value sustainability and that we show this through all our actions. In 2022 we were very pleased to accept the Aalberts sustainability awards 2021.



The VOKA sustainability charter: SDG pioneers

The VOKA sustainability charter was achieved by Henco for the 3rd year in a row. With this, we have officially been appointed as SDG pioneers. Sustainability is held in high esteem at Henco, this certificate proves it and we are proud of it.



Environmental and health statement Cochebat

The French HVAC association Cochebat has tested and approved our Henco multilayer pipes and we were rewarded with inclusion in their Environmental and Health Statement.



Interseroh Certificate Resources Saved

In 2020 and 2021 Henco received the Interseroh Certificate for Resources Saved in Germany. By recycling materials in 2021, a calculated 42,269 kilograms of resources and, in addition to this, 5,521 kilograms of greenhouse gases were saved.



Valobat

Henco joined Valobat voluntarily in 2023. Valobat is a French eco-organization for the building industry approved by the public authorities, offering services to accelerate the circular economy in the building industry.



	<i>Page</i>
STANDARD (PE-Xc/AL/PE-Xc)	7
RIXc (PE-Xc/AL/PE-Xc)	14
FLOOR-RIXc (PE-Xc/AL/PE-Xc)	19
PE-Xc	20
PE-RT	21
PROTECTION HOSE	22
GAS STANDARD (PE-Xc/AL/PE-Xc)	23
SPRINKLER STANDARD (PE-Xc/AL/PE-Xc)	24



Maximum working pressure (bar) for the different pipe types and diameters

Diameter (mm)	12	14	16	16	18	18	20	20	26	26	32	40	50	63	75	90
Pipe type	STA	STA	STA	RIXC	STA	RIXC	STA	RIXC	STA	RIXC	STA	STA	STA	STA	STA	STA
Max working pressure (bar)	6	10	16	10	10	10	16	10	16	10	16	10	10	10	10	10

Type: COIL STANDARD



Henco multilayer pipe Standard (Coil)

Henco meerlagenbuis Standard (Rol)

Henco tube multicouche Standard (Rouleau)

Henco Mehrschichtverbundrohr Standard (Rohr)

Article number	Coil / Pallet	Type	Pallet dimension (mm)
100-121688*	100 m / 2200 m	12x1,6	800x800
200-121688*	200 m / 3000 m	12x1,6	800x800
100-140210	100 m / 2200 m	14x2	800x800
200-140210	200 m / 3000 m	14x2	800x800
50-160212	50 m / 1500 m	16x2	1200x800
100-160212	100 m / 2200 m	16x2	800x800
200-160212	200 m / 2600 m	16x2	800x800
500-160212D	500 m / 2500 m	16x2	800x800
100-180214	100 m / 1700 m	18x2	800x800
200-180214	200 m / 2000 m	18x2	800x800
25-200216	25 m / 800 m	20x2	1200x800
50-200216	50 m / 1000 m	20x2	1200x800
100-200216	100 m / 1500 m	20x2	800x800
50-260320	50 m / 800 m	26x3	800x800
50-320326	50 m / 650 m	32x3	900x900

*6 bar - 60°C

Type: COIL CSC



Henco multilayer pipe Standard (Coil with small core)

Henco meerlagenbuis Standard (Rol kleine kern)

Henco tube multicouche Standard (Petit rouleau noyau intérieure)

Henco Mehrschichtverbundrohr Standard (Rohr kleinen Kern)

Article number	Coil / Pallet	Type	Pallet dimension (mm)
10-160212-KB	10 m / 800 m	16x2	1200x800
25-160212-KB	25 m / 1125 m	16x2	1200x800
25-200216-KB	25 m / 900 m	20x2	1200x800

internal diameter coil 28cm



Henco Pipes

STANDARD (PE-Xc/AL/PE-Xc)

1 Type: STRAIGHT LENGTH



Henco multilayer pipe Standard (Straight length)

Henco meerlagenbuis (Stang)

Henco tube multicouche Standard (Barre)

Henco Mehrschichtverbundrohr (Stange)

Article number	Cylinder / Pallet	Type	Floor space (mm)
03-160212	75 m / 3600 m	16x2	4000x705
04-160212	100 m / 4800 m	16x2	4100x705
05-160212	125 m / 6000 m	16x2	5100x705
03-180214	60 m / 2880 m	18x2	4000x705
05-180214	100 m / 4800 m	18x2	5100x705
03-200216	54 m / 2592 m	20x2	4000x705
04-200216	72 m / 3456 m	20x2	4100x705
05-200216	90 m / 4320 m	20x2	5100x705
03-260320	30 m / 1440 m	26x3	4000x705
04-260320	40 m / 1920 m	26x3	4100x705
05-260320	50 m / 2400 m	26x3	5100x705
03-320326	21 m / 1008 m	32x3	4000x705
04-320326	28 m / 1344 m	32x3	4100x705
05-320326	35 m / 1680 m	32x3	5100x705
03-403533	27 m / 648 m	40x3,5	4000x705
04-403533	36 m / 864 m	40x3,5	4100x705
05-403533	45 m / 1080 m	40x3,5	5100x705
03-504042	21 m / 504 m	50x4	4000x705
04-504042	28 m / 672 m	50x4	4100x705
05-504042	35 m / 840 m	50x4	5100x705
03-634554	12 m / 288 m	63x4,5	4000x705
04-634554	16 m / 384 m	63x4,5	4100x705
05-634554	20 m / 480 m	63x4,5	5100x705
05-756063	10 m / 240 m	75x6	5100x705
05-907076	5 m / 240 m	90x7	5100x705

Type: ISO4 (6 mm) Fireclass: CL, s1-d0



Henco tube pre-insulated Standard (6mm)

Henco voorgeïsoleerde buis Standard (6mm)

Henco tube pré-isolé Standard (6mm)

Henco Rohr Isoliert Standard (6mm)

Article number	Coil / Pallet	Type	Pallet dimension (mm)
100-ISO4-14-RO	100 m / 1000 m	14x2 red	800x800
100-ISO4-14-BL	100 m / 1000 m	14x2 blue	800x800
50-ISO4-16-RO	50 m / 900 m	16x2 red	800x800
50-ISO4-16-BL	50 m / 900 m	16x2 blue	800x800
100-ISO4-16-RO	100 m / 900 m	16x2 red	800x800
100-ISO4-16-BL	100 m / 900 m	16x2 blue	800x800
50-ISO4-18-RO	50 m / 650 m	18x2 red	800x800
50-ISO4-18-BL	50 m / 650 m	18x2 blue	800x800
50-ISO4-20-RO	50 m / 700 m	20x2 red	800x800
50-ISO4-20-BL	50 m / 700 m	20x2 blue	800x800
100-ISO4-20-RO	100 m / 1100 m	20x2 red	800x800
100-ISO4-20-BL	100 m / 900 m	20x2 blue	800x800
25-ISO4-26-RO	25 m / 400 m	26x3 red	800x800
25-ISO4-26-BL	25 m / 400 m	26x3 blue	800x800
50-ISO4-26-RO	50 m / 500 m	26x3 red	800x800
50-ISO4-26-BL	50 m / 500 m	26x3 blue	800x800
25-ISO4-32-RO	25 m / 300 m	32x3 red	800x800
25-ISO4-32-BL	25 m / 300 m	32x3 blue	800x800
50-ISO4-32-RO	50 m / 300 m	32x3 red	800x800
50-ISO4-32-BL	50 m / 300 m	32x3 blue	800x800



Did you know that you can use the hand-tearable repair tape to almost invisibly repair the Henco pre-insulated pipes?

> Find more information on **p. 162**

1

2

3

4

5

6

7

8

9

10

11

12

Type: ISO4 BSD (6 mm) Fireclass: BL, s1-d0

NEW
PRODUCT



Henco tube pre-insulated Standard (6mm) - Improved fire class
Henco voorgeïsoleerde buis Standard (6mm) - verbeterde brandklasse
Henco tube pré-isolé Standard (6mm) - meilleur classement au feu
Henco Rohr Isoliert Standard (6mm) - Verbesserte Brandklasse

Article number	Coil / Pallet	Type	Pallet dimension (mm)
100-ISO4-14-BL-BSD	100 m / 1000 m	14x2 blue	800x800
100-ISO4-14-RO-BSD	100 m / 1000 m	14x2 red	800x800
50-ISO4-16-BL-BSD	50 m / 800 m	16x2 blue	800x800
50-ISO4-16-RO-BSD	50 m / 900 m	16x2 red	800x800
100-ISO4-16-BL-BSD	100 m / 900 m	16x2 blue	800x800
100-ISO4-16-RO-BSD	100 m / 900 m	16x2 red	800x800
50-ISO4-18-BL-BSD	50 m / 650 m	18x2 blue	800x800
50-ISO4-18-RO-BSD	50 m / 650 m	18x2 red	800x800
50-ISO4-20-BL-BSD	50 m / 700 m	20x2 blue	800x800
50-ISO4-20-RO-BSD	50 m / 700 m	20x2 red	800x800
100-ISO4-20-BL-BSD	100 m / 900 m	20x2 blue	800x800
100-ISO4-20-RO-BSD	100 m / 1100 m	20x2 red	800x800
25-ISO4-26-BL-BSD	25 m / 400 m	26x3 blue	800x800
25-ISO4-26-RO-BSD	25 m / 400 m	26x3 red	800x800
50-ISO4-26-BL-BSD	50 m / 500 m	26x3 blue	800x800
50-ISO4-26-RO-BSD	50 m / 500 m	26x3 red	800x800
25-ISO4-32-BL-BSD	25 m / 300 m	32x3 blue	800x800
25-ISO4-32-RO-BSD	25 m / 300 m	32x3 red	800x800
50-ISO4-32-BL-BSD	50 m / 300 m	32x3 blue	800x800
50-ISO4-32-RO-BSD	50 m / 300 m	32x3 red	800x800

Type: ISO9 (10 mm) Fireclass: CL, s1-d0



Henco tube pre-insulated Standard (10mm)
Henco voorgeïsoleerde buis Standard (10mm)
Henco tube pré-isolé Standard (10mm)
Henco Rohr Isoliert Standard (10mm)

Article number	Coil / Pallet	Type	Pallet dimension (mm)
50-ISO9-14-RO	50 m / 550 m	14x2 red	800x800
50-ISO9-14-BL	50 m / 550 m	14x2 blue	800x800
50-ISO9-16-RO	50 m / 600 m	16x2 red	800x800
50-ISO9-16-BL	50 m / 600 m	16x2 blue	800x800
50-ISO9-18-RO	50 m / 500 m	18x2 red	800x800
50-ISO9-18-BL	50 m / 500 m	18x2 blue	800x800
50-ISO9-20-RO	50 m / 400 m	20x2 red	800x800



Henco Pipes

STANDARD (PE-Xc/AL/PE-Xc)

1 Type: ISO9 (10 mm) Fireclass: CL, s1-d0



Article number	Coil / Pallet	Type	Pallet dimension (mm)
50-ISO9-20-BL	50 m / 400 m	20x2 blue	800x800
25-ISO9-26-RO	25 m / 275 m	26x3 red	800x800
25-ISO9-26-BL	25 m / 325 m	26x3 blue	800x800
50-ISO9-26-RO	50 m / 450 m	26x3 red	800x800
50-ISO9-26-BL	50 m / 450 m	26x3 blue	800x800
25-ISO9-32-RO	25 m / 250 m	32x3 red	800x800
25-ISO9-32-BL	25 m / 250 m	32x3 blue	800x800
50-ISO9-32-RO	50 m / 250 m	32x3 red	800x800
50-ISO9-32-BL	50 m / 250 m	32x3 blue	800x800

8 Type: ISO9 BSD (10 mm) Fireclass: BL, s1-d0



Henco tube pre-insulated Standard (10mm) - Improved fire class
 Henco voorgeïsoleerde buis Standard (10mm) - verbeterde brandklasse
 Henco tube pré-isolé Standard (10mm) - meilleur classement au feu
 Henco Rohr Isoliert Standard (10mm) - Verbesserte Brandklasse

Article number	Coil / Pallet	Type	Pallet dimension (mm)
50-ISO9-14-BL-BSD	50 m / 550 m	14x2 blue	800x800
50-ISO9-14-RO-BSD	50 m / 550 m	14x2 red	800x800
50-ISO9-16-BL-BSD	50 m / 600 m	16x2 blue	800x800
50-ISO9-16-RO-BSD	50 m / 600 m	16x2 red	800x800
50-ISO9-18-BL-BSD	50 m / 500 m	18x2 blue	800x800
50-ISO9-18-RO-BSD	50 m / 500 m	18x2 red	800x800
50-ISO9-20-BL-BSD	50 m / 400 m	20x2 blue	800x800
50-ISO9-20-RO-BSD	50 m / 400 m	20x2 red	800x800
25-ISO9-26-BL-BSD	25 m / 325 m	26x3 blue	800x800
25-ISO9-26-RO-BSD	25 m / 275 m	26x3 red	800x800
50-ISO9-26-BL-BSD	50 m / 450 m	26x3 blue	800x800
50-ISO9-26-RO-BSD	50 m / 450 m	26x3 red	800x800
25-ISO9-32-BL-BSD	25 m / 250 m	32x3 blue	800x800
25-ISO9-32-RO-BSD	25 m / 250 m	32x3 red	800x800
50-ISO9-32-BL-BSD	50 m / 250 m	32x3 blue	800x800
50-ISO9-32-RO-BSD	50 m / 350 m	32x3 red	800x800

10 Type: ISO13 (13 mm) Fireclass: CL, s1-d0



Henco tube pre-insulated Standard (13mm)
 Henco voorgeïsoleerde buis Standard (13mm)
 Henco tube pré-isolé Standard (13mm)
 Henco Rohr Isoliert Standard (13mm)

Article number	Coil / Pallet	Type	Pallet dimension (mm)
50-ISO13-16-BL	50 m / 400 m	16x2 blue	800x800
50-ISO13-16-RO	50 m / 400 m	16x2 red	800x800
50-ISO13-18-BL*	50 m / 450 m	18x2 blue	800x800
50-ISO13-20-BL	50 m / 400 m	20x2 blue	800x800
50-ISO13-20-RO	50 m / 400 m	20x2 red	800x800
50-ISO13-26-BL	50 m / 300 m	26x3 blue	800x800
50-ISO13-26-RO	50 m / 300 m	26x3 red	800x800
25-ISO13-32-BL	25 m / 225 m	32x3 blue	800x800
25-ISO13-32-RO	25 m / 225 m	32x3 red	800x800

*TILL EXHAUSTION OF STOCK



Did you know that you can use the hand-tearable repair tape to almost invisibly repair the Henco pre-insulated pipes?

> Find more information on **p. 162**

Type: ISO13 BSD (13 mm) Fireclass: BL, s1-d0

NEW*
PRODUCT



Henco tube pre-insulated Standard (13mm) - Improved fire class
 Henco voorgeïsoleerde buis Standard (13mm) - verbeterde brandklasse
 Henco tube pré-isolé Standard (13mm) - meilleur classement au feu
 Henco Rohr Isoliert Standard (13mm) - Verbesserte Brandklasse

Article number	Coil / Pallet	Type	Pallet dimension (mm)
50-ISO13-16-BL-BSD	50 m / 400 m	16x2 blue	800x800
50-ISO13-16-RO-BSD	50 m / 400 m	16x2 red	800x800
50-ISO13-18-BL-BSD	50 m / 450 m	18x2 blue	800x800
50-ISO13-18-RO-BSD	50 m / 450 m	18x2 red	800x800
50-ISO13-20-BL-BSD	50 m / 400 m	20x2 blue	800x800
50-ISO13-20-RO-BSD	50 m / 400 m	20x2 red	800x800
50-ISO13-26-BL-BSD	50 m / 300 m	26x3 blue	800x800
50-ISO13-26-RO-BSD	50 m / 300 m	26x3 red	800x800
25-ISO13-32-BL-BSD	25 m / 200 m	32x3 blue	800x800
25-ISO13-32-RO-BSD	25 m / 225 m	32x3 red	800x800

Type: ISO20 BSD (20 mm) Fireclass: BL, s1-d0

NEW*
PRODUCT



Henco tube pre-insulated Standard (20mm) - Improved fire class
 Henco voorgeïsoleerde buis Standard (20mm) - verbeterde brandklasse
 Henco tube pre-insulated Standard (20mm) - meilleur classement au feu
 Henco Rohr Isoliert Standard (20mm) - Verbesserte Brandklasse

Article number	Coil / Pallet	Type	Pallet dimension (mm)
25-ISO20-32-BL-BSD	25 m / 150 m	32x3 blue	800x800
25-ISO20-32-RO-BSD	25 m / 150 m	32x3 red	800x800



Henco Pipes

STANDARD (PE-Xc/AL/PE-Xc)

1 Type: STANDARD PIPE IN PIPE



Henco multilayer pipe with colour coded conduit Standard (Coil)
 Henco meerlagenbuis met mantel Standard (Rol)
 Henco tube multicouche avec gaine Standard (Rouleau)
 Henco Mehrschichtverbundrohr mit Mantel Standard (Ring)

Article number	Coil / Pallet	Type	Pallet dimension (mm)
50-014MR	50 m / 800 m	14x2 red	1200x800
50-014MB	50 m / 800 m	14x2 blue	1200x800
25-016MR	25 m / 500 m	16x2 red	1200x800
25-016MB	25 m / 500 m	16x2 blue	1200x800
50-016MR	50 m / 800 m	16x2 red	1200x800
50-016MB	50 m / 800 m	16x2 blue	1200x800
50-016MBLACK	50 m / 800 m	16x2 black	1200x800
100-016MR	100 m / 1000 m	16x2 red	1200x800
100-016MB	100 m / 1000 m	16x2 blue	1200x800
100-016MBLACK	100 m / 1000 m	16x2 black	1200x800
50-018MR	50 m / 800 m	18x2 red	1200x800
50-018MB	50 m / 800 m	18x2 blue	1200x800
100-018MR	100 m / 1000 m	18x2 blue	1200x800
100-018MB	100 m / 1000 m	18x2 blue	1200x800
25-020MR	25 m / 500 m	20x2 red	1200x800
25-020MB	25 m / 500 m	20x2 blue	1200x800
25-020MBLACK	25 m / 500 m	20x2 black	1200x800
50-020MR	50 m / 800 m	20x2 red	1200x800
50-020MB	50 m / 800 m	20x2 blue	1200x800
50-020MBLACK	50 m / 800 m	20x2 black	1200x800
100-020MB	100 m / 1000 m	20x2 blue	1200x800
100-020MR	100 m / 1000 m	20x2 red	1200x800
25-026MR	25 m / 500 m	26x3 blue	1200x800
25-026MB	25 m / 500 m	26x3 blue	1200x800
50-026MR	50 m / 500 m	26x3 blue	1200x800
50-026MB	50 m / 500 m	26x3 blue	1200x800
50-026MBLACK	50 m / 500 m	26x3 black	1200x800
25-032MR	25 m / 300 m	32x3 red	900x900
25-032MB	25 m / 300 m	32x3 blue	900x900

Type: COMBI STANDARD



Henco Combi Standard (Coil)
 Henco Combi Standard (Rol)
 Henco Combi Standard (Rouleau)
 Henco Combi Standard (Rohr)

Article number	Coil / Pallet	Type	Pallet dimension (mm)
50-COMBI16	50 m / 500 m	16x2	1200x800



Type: FLEX STANDARD

NEW PRODUCT



Henco Flex (Coil)
Henco Flex (Rol)
Henco Flex (Rouleau)
Henco Flex (Ring)

Article number	Coil	Type	Pallet dimension (mm)
1-FLEX32	1 m	32x3	1200x1200



Did you know you could use the rubber end cap HFMAN125 to provide a watertight seal on the Henco FLEX32 ends?

> Find more information on **p. 162**

Type: STANDARD PIPE IN PIPE CSC



Henco multilayer pipe with colour coded conduit Standard (Coil small coil)
Henco meerlagenbuis met mantel Standard (Rol kleine kern)
Henco tube multicouche avec gaine Standard (Rouleau noyau intérieure)
Henco Mehrschichtverbundrohr mit Mantel Standard (Ring kleinen Kern)

Article number	Coil / Pallet	Type	Pallet dimension (mm)
25-016MB-KB	25 m / 600 m	16x2 blue	1200x800
25-016MR-KB	25 m / 600 m	16x2 red	1200x800

internal diameter coil 28cm

Type: LB



Carcassing pipe 16mm
Dubbele radiatorbocht, 16mm, doorverbonden einde
Double courbe radiateur, 16mm, embout fermé
Heizkörperwinkel doppelt, 16mm, durchgestellt Ende

Article number	Bag	Type
LB50	1 pc.	Ø16, centre-to-centre = 50mm

Type: ISO-BLOCK-S

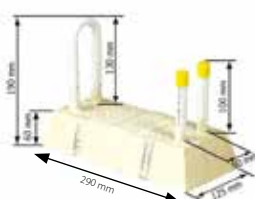

Carcassing pipe 16mm with insulation
Dubbele radiatorbocht met isolatie, 16mm, doorverbonden einde
Double courbe radiateur, 16mm, avec isolation, embout fermé
Heizkörperwinkel doppelt mit Isolation, 16mm, durchgestellt Ende

Article number	Box	Type
ISO-BLOCK-S	50 pc.	Ø16, centre-to-centre = 50mm



Henco Pipes

RIXc (PE-Xc/AL/PE-Xc)

1

Maximum working pressure (bar) for the different pipe types and diameters

Diameter (mm)	12	14	16	16	18	18	20	20	26	26	32	40	50	63	75	90
Pipe type	STA	STA	STA	RIXc	STA	RIXc	STA	RIXc	STA	RIXc	STA	STA	STA	STA	STA	STA
Max working pressure (bar)	6	10	16	10	10	10	16	10	16	10	16	10	10	10	10	10

2

3

4

5

Type: COIL RIXc



- Henco multilayer pipe RIXc (Coil)
- Henco meerlagenbuis RIXc (Rol)
- Henco tube multicouche RIXc (Rouleau)
- Henco Mehrschichtverbundrohr RIXc (Rohr)

Article number	Coil / Pallet	Type	Pallet dimension (mm)
50-R160212	50 m / 1500 m	16x2	1200x800
100-R160212	100 m / 2200 m	16x2	800x800
200-R160212	200 m / 2600 m	16x2	800x800
500-R160212D	500 m / 2500 m	16x2	800x800
100-R180214	100 m / 1700 m	18x2	800x800
200-R180214	200 m / 2000 m	18x2	800x800
50-R200216	50 m / 1000 m	20x2	1200x800
100-R200216	100 m / 1500 m	20x2	800x800
25-R260320		26x3	1200x800
50-R260320	50 m / 800 m	26x3	1200x800

8

9

10

11

12

Type: COIL RIXc CSC



- Henco multilayer pipe RIXc (Coil with small core)
- Henco meerlagenbuis RIXc (Rol kleine kern)
- Henco tube multicouche RIXc (Petit rouleau noyau intérieure)
- Henco Mehrschichtverbundrohr RIXc (Rohr kleinen Kern)

Article number	Coil / Pallet	Type	Pallet dimension (mm)
10-R160212-KB	10 m / 800 m	16x2	1200x800
15-R160212-KB	15 m / 900 m	16x2	1200x800
25-R160212-KB	25 m / 1125 m	16x2	1200x800
10-R200216-KB	10 m / 550 m	20x2	1200x800
25-R200216-KB	25 m / 900 m	20x2	1200x800

internal diameter coil 28cm

Type: STRAIGHT LENGTH RIXc



- Henco multilayer pipe RIXc (Straight length)
- Henco meerlagenbuis RIXc (Stang)
- Henco tube multicouche RIXc (Barre)
- Henco Mehrschichtverbundrohr RIXc (Stange)

Article number	Cylinder / Pallet	Type	Floor space (mm)
03-R160212	75 m / 3600 m	16x2	4000x705
04-R160212	100 m / 4800 m	16x2	4100x705
05-R160212	125 m / 6000 m	16x2	5100x705
03-R200216	54 m / 2592 m	20x2	4000x705
04-R200216	72 m / 3456 m	20x2	4100x705
05-R200216	90 m / 4320 m	20x2	5100x705
03-R260320	30 m / 1440 m	26x3	4000x705
04-R260320	40 m / 1920 m	26x3	4100x705
05-R260320	50 m / 2400 m	26x3	5100x705



Did you know that you can use the hand-tearable repair tape to almost invisibly repair the Henco pre-insulated pipes?

> Find more information on **p. 162**

Type: ISO4 (6 mm) RIXc **Fireclass: CL, s1-d0**



Henco tube pre-insulated RIXc (6mm)
 Henco voorgeïsoleerde buis RIXc (6mm)
 Henco tube pré-isolé RIXc (6mm)
 Henco Rohr Isoliert RIXc (6mm)

Article number	Coil / Pallet	Type	Pallet dimension (mm)
50-ISO4-R16-BL	50 m / 800 m	16x2 blue	800x800
50-ISO4-R16-RO	50 m / 800 m	16x2 red	800x800
100-ISO4-R16-RO	100 m / 900 m	16x2 red	800x800
100-ISO4-R16-BL	100 m / 900 m	16x2 blue	800x800
50-ISO4-R18-RO	50 m / 650 m	18x2 red	800x800
50-ISO4-R18-BL	50 m / 650 m	18x2 blue	800x800
50-ISO4-R20-RO	50 m / 700 m	20x2 red	800x800
50-ISO4-R20-BL	50 m / 700 m	20x2 blue	800x800
25-ISO4-R26-RO	25 m / 300 m	26x3 red	800x800
25-ISO4-R26-BL	25 m / 300 m	26x3 blue	800x800
50-ISO4-R26-RO	50 m / 500 m	26x3 red	800x800
50-ISO4-R26-BL	50 m / 500 m	26x3 blue	800x800

Type: ISO4 BSD (6 mm) RIXc **Fireclass: BL, s1-d0**



Henco tube pre-insulated RIXc (6mm) - Improved fire class
 Henco voorgeïsoleerde buis RIXc (6mm) - verbeterde brandklasse
 Henco tube pré-isolé RIXc (6mm) - meilleur classement au feu
 Henco Rohr Isoliert RIXc (6mm) - Verbesserte Brandklasse

Article number	Coil / Pallet	Type	Pallet dimension (mm)
100-ISO4-R16-BL-BSD	100 m / 900 m	16x2 blue	800x800
100-ISO4-R16-RO-BSD	100 m / 900 m	16x2 red	800x800
50-ISO4-R16-BL-BSD	50 m / 900 m	16x2 blue	800x800
50-ISO4-R16-RO-BSD	50 m / 800 m	16x2 red	800x800
25-ISO4-R16-BL-BSD	25 m / 250 m	16x2 blue	800x800
25-ISO4-R16-RO-BSD	25 m / 250 m	16x2 red	800x800
50-ISO4-R18-BL-BSD	50 m / 650 m	18x2 blue	800x800
50-ISO4-R18-RO-BSD	50 m / 650 m	18x2 red	800x800
50-ISO4-R20-BL-BSD	50 m / 700 m	20x2 blue	800x800
50-ISO4-R20-RO-BSD	50 m / 700 m	20x2 red	800x800
50-ISO4-R26-BL-BSD	50 m / 500 m	26x3 blue	800x800
50-ISO4-R26-RO-BSD	50 m / 500 m	26x3 red	800x800
25-ISO4-R26-BL-BSD	25 m / 300 m	26x3 blue	800x800
25-ISO4-R26-RO-BSD	25 m / 300 m	26x3 red	800x800

- 1
- 2
- 3
- 4
- 5
- 6
- 7
- 8
- 9
- 10
- 11
- 12



Henco Pipes

RIXc (PE-Xc/AL/PE-Xc)

1

Type: ISO9 (10 mm) RIXc Fireclass: CL, s1-d0



Henco tube pre-insulated RIXc (10mm)
 Henco voorgeïsoleerde buis RIXc (10mm)
 Henco tube pré-isolé RIXc (10mm)
 Henco Rohr Isoliert RIXc (10mm)

Article number	Coil / Pallet	Type	Pallet dimension (mm)
50-ISO9-R16-RO	50 m / 600 m	16x2 red	800x800
50-ISO9-R16-BL	50 m / 600 m	16x2 blue	800x800
50-ISO9-R20-RO	50 m / 400 m	20x2 red	800x800
50-ISO9-R20-BL	50 m / 400 m	20x2 blue	800x800
25-ISO9-R26-RO	25 m / 325 m	26x3 red	800x800
25-ISO9-R26-BL	25 m / 325 m	26x3 blue	800x800
50-ISO9-R26-BL	50 m / 400 m	26x3 blue	800x800
50-ISO9-R26-RO	50 m / 400 m	26x3 red	800x800

2

3

4

5

6

7

8

9

Type: ISO9BSD (10mm) RIXc Fireclass: BL, s1-d0



Henco tube pre-insulated RIXc (10mm) - Improved fire class
 Henco voorgeïsoleerde buis RIXc (10mm) - verbeterde brandklasse
 Henco tube pré-isolé RIXc (10mm) - meilleur classement au feu
 Henco Rohr Isoliert RIXc (10mm) - Verbesserte Brandklasse

Article number	Coil / Pallet	Type	Pallet dimension (mm)
50-ISO9-R16-BL-BSD	50 m / 600 m	16x2 blue	800x800
50-ISO9-R16-RO-BSD	50 m / 600 m	16x2 red	800x800
50-ISO9-R20-BL-BSD	50 m / 400 m	20x2 blue	800x800
50-ISO9-R20-RO-BSD	50 m / 400 m	20x2 red	800x800
50-ISO9-R26-BL-BSD	50 m / 400 m	26x3 blue	800x800
50-ISO9-R26-RO-BSD	50 m / 400 m	26x3 red	800x800
25-ISO9-R26-BL-BSD	25 m / 325 m	26x3 blue	800x800
25-ISO9-R26-RO-BSD	25 m / 325 m	26x3 red	800x800

10

11

12

Type: ISO13 (13 mm) RIXc Fireclass: CL, s1-d0



Henco tube pre-insulated RIXc (13mm)
 Henco voorgeïsoleerde buis RIXc (13mm)
 Henco tube pré-isolé RIXc (13mm)
 Henco Rohr Isoliert RIXc (13mm)

Article number	Coil / Pallet	Type	Pallet dimension (mm)
50-ISO13-R16-BL	50 m / 400 m	16x2 blue	800x800
50-ISO13-R16-RO	50 m / 400 m	16x2 red	800x800
50-ISO13-R20-BL	50 m / 400 m	20x2 blue	800x800
50-ISO13-R20-RO	50 m / 400 m	20x2 red	800x800
50-ISO13-R26-BL	50 m / 300 m	26x3 blue	800x800
50-ISO13-R26-RO	50 m / 300 m	26x3 red	800x800



Did you know that you can use the hand-tearable repair tape to almost invisibly repair the Henco pre-insulated pipes?

> Find more information on **p. 162**

1

2

3

4

5

6

7

8

9

10

11

12

Type: ISO13BSD (13mm) RIXc **Fireclass: BL, s1-d0**



Henco tube pre-insulated RIXc (13mm) - Improved fire class
 Henco voorgeïsoleerde buis RIXc (13mm) - verbeterde brandklasse
 Henco tube pré-isolé RIXc (13mm) - meilleur classement au feu
 Henco Rohr Isoliert RIXc (13mm) - Verbesserte Brandklasse

Article number	Coil / Pallet	Type	Pallet dimension (mm)
50-ISO13-R16-BL-BSD	50 m / 400 m	16x2 blue	800x800
50-ISO13-R16-RO-BSD	50 m / 400 m	16x2 red	800x800
50-ISO13-R20-BL-BSD	50 m / 400 m	20x2 blue	800x800
50-ISO13-R20-RO-BSD	50 m / 400 m	20x2 red	800x800
50-ISO13-R26-BL-BSD	50 m / 300 m	26x3 blue	800x800
50-ISO13-R26-RO-BSD	50 m / 300 m	26x3 red	800x800

Type: ISO20 (20mm) RIXc **Fireclass: CL, s1-d0**



Henco tube pre-insulated RIXc (20mm)
 Henco voorgeïsoleerde buis RIXc (20mm)
 Henco tube pre-insulated RIXc (20mm)
 Henco Rohr Isoliert RIXc (20mm)

Article number	Coil / Pallet	Type	Pallet dimension (mm)
50-ISO20-R16-RO	50 m / 250 m	16x2 red	800x800
50-ISO20-R16-BL	50 m / 250 m	16x2 blue	800x800
50-ISO20-R20-RO	50 m / 250 m	20x2 red	800x800
50-ISO20-R20-BL	50 m / 250 m	20x2 blue	800x800
25-ISO20-R26-RO	25 m / 175 m	26x3 red	800x800
25-ISO20-R26-BL	25 m / 175 m	26x3 blue	800x800

Type: ISO20BSD (20mm) RIXc **Fireclass: BL, s1-d0**



Henco tube pre-insulated RIXc (20mm) - Improved fire class
 Henco voorgeïsoleerde buis RIXc (20mm) - verbeterde brandklasse
 Henco tube pre-insulated RIXc (20mm) - meilleur classement au feu
 Henco Rohr Isoliert RIXc (20mm) - Verbesserte Brandklasse

Article number	Coil / Pallet	Type	Pallet dimension (mm)
50-ISO20-R16-BL-BSD	50 m / 250 m	16x2 blue	800x800
50-ISO20-R16-RO-BSD	50 m / 250 m	16x2 red	800x800
50-ISO20-R20-BL-BSD	50 m / 250 m	20x2 blue	800x800
50-ISO20-R20-RO-BSD	50 m / 250 m	20x2 red	800x800
25-ISO20-R26-BL-BSD	25 m / 175 m	26x3 blue	800x800
25-ISO20-R26-RO-BSD	25 m / 175 m	26x3 red	800x800



Henco Pipes

RIXc (PE-Xc/AL/PE-Xc)

- 1
- 2
- 3
- 4
- 5
- 6
- 7
- 8
- 9
- 10
- 11
- 12

Type: COMBI ISO4 (6 mm) RIXc Fireclass: CL, s1-d0



Henco Combi ISO RIXc (Coil)
 Henco Combi ISO RIXc (Rol)
 Henco Combi ISO RIXc (Rouleau)
 Henco Combi ISO RIXc (Ring)

Article number	Coil / Pallet	Type	Pallet dimension (mm)
50-ISO4-COMBI16R	50 m / 400 m	16x2	800x800

Type: RIXc PIPE IN PIPE Fireclass: CL, s1-d0



Henco tube with colour coded conduit RIXc
 Henco buis met mantel RIXc
 Henco tube avec gaine RIXc
 Henco Rohr mit Mantel RIXc

Article number	Coil / Pallet	Type	Pallet dimension (mm)
25-R16MR	25 m / 500 m	16x2 red	1200x800
25-R16MB	25 m / 500 m	16x2 blue	1200x800
50-R16MR	50 m / 1000 m	16x2 red	1200x800
50-R16MB	50 m / 1000 m	16x2 blue	1200x800
50-R16MBLACK	50 m / 1000 m	16x2 black	1200x800
100-R16MR	100 m / 1000 m	16x2 red	1200x800
100-R16MB	100 m / 1000 m	16x2 blue	1200x800
100-R16MBLACK	100 m / 1000 m	16x2 black	1200x800
50-R18MR	50 m / 800 m	18x2 blue	1200x800
50-R18MB	50 m / 800 m	18x2 blue	1200x800
25-R20MR	25 m / 500 m	20x2 red	1200x800
25-R20MB	25 m / 500 m	20x2 blue	1200x800
25-R20MBLACK	25 m / 800 m	20x2 black	1200x800
50-R20MR	50 m / 800 m	20x2 red	1200x800
50-R20MB	50 m / 800 m	20x2 blue	1200x800
100-R20MR	100 m / 1000 m	20x2 red	1200x800
100-R20MB	100 m / 1000 m	20x2 blue	1200x800
50-R26MR	50 m / 500 m	26x3 blue	1200x800
50-R26MB	50 m / 500 m	26x3 blue	1200x800

Type: COMBI RIXc Fireclass: CL, s1-d0



Henco Combi RIXc (Coil)
 Henco Combi RIXc (Rol)
 Henco Combi RIXc (Rouleau)
 Henco Combi RIXc (Rohr)

Article number	Coil / Pallet	Type	Pallet dimension (mm)
50-COMBI16R	50 m / 500 m	16x2	1200x800



Type: FLOOR-RIXc



Henco multilayer pipe (Coil)
 Henco meerlagenbuis (Rol)
 Henco tube multicouche (Rouleau)
 Henco Mehrschichtverbundrohr (Ring)

Article number	Coil / Pallet	Type	Pallet dimension (mm)
100-F16R-WZ	100 m / 2200 m	16x2	800x800
200-F16R-WZ	200 m / 2600 m	16x2	800x800
500-F16R-WZ	500 m / 1500 m	16x2	800x800
100-F20R-WZ	100 m / 1000 m	20x2	800x800

6 bar - 60°C

1

2

3

4

5

6

7

8

9

10

11

12



Henco Pipes

PE-Xc

1 Type: 5L PE-Xc



- Henco 5L PE-Xc pipe PE-Xc/EVOH/PE-Xc (Coil)
- Henco 5L PE-Xc buis PE-Xc/EVOH/PE-Xc (Rol)
- Henco 5L PE-Xc tube PE-Xc/EVOH/PE-Xc (Rouleau)
- Henco 5L PE-Xc Rohr PE-Xc/EVOH/PE-Xc (Ring)

Article number	Coil / Pallet	Type	Pallet dimension (mm)
200-PXC1620	200 m / 1600 m	16x2	800x800
600-PXC1620	600 m / 2400 m	16x2	800x800
200-PXC1720	200 m / 2000 m	17x2	800x800
600-PXC1720	600 m / 2400 m	17x2	800x800
240-PXC1820	240 m / 2160 m	18x2	800x800
200-PXC2020	200 m / 1000 m	20x2	800x800
600-PXC2020	600 m / 1200 m	20x2	800x800



Type: 5L PE-RT



Henco 5L PE-RT pipe PE-RT/EVOH/PE-RT (Coil)

Henco 5L PE-RT pipe PE-RT/EVOH/PE-RT (Rol)

Henco 5L PE-RT pipe PE-RT/EVOH/PE-RT (Rouleau)

Henco 5L PE-RT pipe PE-RT/EVOH/PE-RT (Ring)

Article number	Coil / Pallet	Type	Pallet dimension (mm)
600-PRT1420	600 m / 2400 m	14x2	800x800
120-PRT1620	120 m / 1440 m	16x2	800x800
270-PRT1620	800 m / 800 m	16x2	800x800
640-PRT1620	600 m / 2400 m	16x2	800x800
600-PRT1720	600 m / 2400 m	17x2	800x800
240-PRT1820	240 m / 1440 m	18x2	800x800
600-PRT1820	600 m / 1800 m	18x2	800x800
600-PRT2020	600 m / 1800 m	20x2	800x800

1

2

3

4

5

6

7

8

9

10

11

12



Henco Pipes

PROTECTION HOSE

1

Type: PROTECTION HOSE

2

3

4

5

6

7

8

9

10



Henco colour coded conduit (Coil)

Henco mantel (Rol)

Henco gaine (Rouleau)

Henco Mantel (Ring)

Article number	Coil / Pallet	Type	Pallet dimension (mm)
100-MR	100 m / 2400 m	Ø14/Ø16/Ø18 red	1200x800
100-MB	100 m / 2400 m	Ø14/Ø16/Ø18 blue	1200x800
100-MBLACK	100 m / 2400 m	Ø14/Ø16/Ø18 black	1200x800
50-MR20	50 m / 1800 m	Ø20 red	1200x800
50-MB20	50 m / 1800 m	Ø20 blue	1200x800
50-MBLACK20	50 m / 1800 m	Ø20 black	1200x800
50-MR26	50 m / 1200 m	Ø26 red	1200x800
50-MB26	50 m / 1200 m	Ø26 blue	1200x800
50-MBLACK26	50 m / 1200 m	Ø26 black	1200x800
25-MR32	25 m / 500 m	Ø32 red	1200x800
25-MB32	25 m / 500 m	Ø32 blue	1200x800

11

Type: PROTECTION HOSE GAS

12



Colour coded conduit GAS (Coil)

Mantel GAS (Rol)

Gaine GAS (Rouleau)

Mantel GAS (Ring)

Article number	Coil / Pallet	Type	Pallet dimension (mm)
50-MG16	50 m / 2400 m	Ø16 yellow	1200x800
100-MG16	100 m / 2400 m	Ø16 yellow	1200x800
50-MG20	50 m / 1800 m	Ø20 yellow	1200x800
50-MG26	50 m / 1200 m	Ø26 yellow	1200x800
25-MG32	25 m / 500 m	Ø32 yellow	1200x800



Gas: only allowed in countries where a HENCO GAS testing + certificate is available! (see www.henco.be)
 Gas: enkel toegelaten in landen waar er een HENCO GAS keur is + een certificaat voorhanden is! (zie www.henco.be)
 Gaz: seulement permis dans des pays où le contrôle a eu lieu + certificat est disponible! (Consultez www.henco.be)
 Gas: nur zugelassen in Länder wo HENCO GAS Prüfung geschehen ist + Zertifikat vorhanden ist! (Siehe www.henco.be)

Type: COIL GAS



Henco multilayer pipe GAS (Coil)
 Henco meerlagenbuis GAS (Rol)
 Henco tube multicouche GAZ (Rouleau)
 Henco Mehrschichtverbundrohr GAS (Rohr)

Article number	Coil / Pallet	Type	Pallet dimension (mm)
50-260320-GAS*	50 m / 800 m	26x3	800x800
50-320326-GAS*	50 m / 650 m	32x3	900x900

*TILL EXHAUSTION OF STOCK

Type: STRAIGHT LENGTH GAS



Henco multilayer pipe GAS (Straight length)
 Henco meerlagenbuis GAS (Stang)
 Henco tube multicouche GAZ (Rouleau)
 Henco Mehrschichtverbundrohr GAS (Stange)

Article number	Cylinder / Pallet	Type	Floor space (mm)
05-160212-GAS	125 m / 6000 m	16x2	5100x705
05-200216-GAS	90 m / 4320 m	20x2	5100x705
05-260320-GAS	50 m / 2400 m	26x3	5100x705
05-320326-GAS	35 m / 1680 m	32x3	5100x705
05-403533-GAS	45 m / 1080 m	40x3,5	5100x705

Type: GAS PIPE IN PIPE



Henco multilayer piper with colour coded conduit GAS (Coil)
 Henco meerlagenbuis met mantel GAS (Rol)
 Henco tube multicouche avec gaine GAZ (Rouleau)
 Henco Mehrschichtverbundrohr mit Mantel GAS (Ring)

Article number	Coil / Pallet	Type	Pallet dimension (mm)
25-016GASMG	25 m / 500 m	16x2	1200x800
50-016GASMG	50 m / 800 m	16x2	1200x800
25-020GASMG	25 m / 500 m	20x2	1200x800
50-020GASMG	50 m / 800 m	20x2	1200x800
50-026GASMG	50 m / 500 m	26x3	1200x800
25-032GASMG	25 m / 300 m	32x3	1200x800
25-026GASMG	25 m / 500 m	26x3	1200x800

Gastec: Standard pipe gas in combination with Henco press fittings synthetic for gas, see page 48

DVGW and Kiwa Uni: Standard pipe gas in combination with Henco brass press fittings for gas, see page 88





Henco Pipes

SPRINKLER STANDARD (PE-Xc/AL/PE-Xc)

- 1
- 2
- 3
- 4
- 5
- 6
- 7
- 8
- 9
- 10
- 11
- 12

Sprinkler: only allowed in countries where a HENCO Sprinkler certificate is available! (see www.henco.be)
Sprinkler: enkel toegelaten in landen waar een HENCO Sprinkler certificaat voorhanden is! (zie www.henco.be)
Sprinkler: seulement permis dans des pays où le HENCO Sprinkler certificat est disponible! (consultez www.henco.be)
Sprinkler: nur zugelassen in Länder wo HENCO Sprinkler Zertifikat vorhanden ist! (siehe www.henco.be)

Type: COIL SPR



Henco multilayer pipe SPRINKLER (Coil)
Henco meerlagenbuis SPRINKLER (rol)
Henco tube multicouche SPRINKLER (Rouleau)
Henco Mehrschichtverbundrohr SPRINKLER (Rohr)

Article number	Coil / Pallet	Type	Pallet dimension (mm)
50-320326-SPR	50 m / 650 m	32x3	900x900

Type: STRAIGHT LENGTH SPR



Henco multilayer pipe SPRINKLER (Straight length)
Henco meerlagenbuis SPRINKLER (Stang)
Henco tube multicouche SPRINKLER (Barre)
Henco Mehrschichtverbundrohr SPRINKLER (Stange)

Article number	Cylinder / Pallet	Type	Floor space (mm)
05-320326-SPR	35 m / 1680 m	32x3	5100x705
05-403533-SPR	45 m / 1080 m	40x3,5	5100x705
05-504042-SPR	35 m / 840 m	50x4	5100x705
05-634554-SPR	20 m / 480 m	63x4,5	5100x705

Standard pipe Sprinkler in combination with Henco synthetic press fittings for Sprinkler, see page 165
 Sprinkler Cup: see chapter 12 on Sprinkler systems





	<i>Page</i>
<i>Henco Press BLACK - PK</i>	<i>26</i>
<i>Henco Press WHITE - PKW</i>	<i>38</i>
<i>Henco Press GAS - PKG</i>	<i>46</i>
<i>Henco Press SUPER SIZES</i>	<i>51</i>
<i>Henco Ecoline</i>	<i>62</i>



Henco Synthetic Press

Henco Press BLACK - PK

Type: 1PK



Elbow 90°
Knie 90°
Coude 90°
Winkel 90°

Article number	Bag / Box	Type
1PK-1414	10 pc. / 150 pc.	14x14
1PK-1616	10 pc. / 120 pc.	16x16
1PK-1818	10 pc. / 100 pc.	18x18
1PK-2020	10 pc. / 80 pc.	20x20
1PK-2626	5 pc. / 50 pc.	26x26
1PK-3232	5 pc. / 30 pc.	32x32
1PK-4040	5 pc. / 20 pc.	40x40
1PK-5050	1 pc. / 8 pc.	50x50
1PK-6363	1 pc. / 6 pc.	63x63

Type: 1PK-JG



Elbow 90° 16x10JG (ceiling cooling)
Knie 90° 16x10JG (koelplafond)
Coude 90° 16x10JG (plafond climatisé)
Winkel 90° 16x10JG (Klimadecke)

Article number	Bag / Box	Type
1PK-20JG10	10 pc. / 100 pc.	20x10JG

Type: 2PK (CW617)



Backplate elbow female
Sanitair muurplaat binnendraad
Culasse pour sanitaire
Sanitär Wandscheibe IG

Article number	Bag / Box	Type
2PK-1404BP	10 pc. / 50 pc.	14x1/2"
2PK-1603	10 pc. / 50 pc.	16x3/8"
2PK-1604BP	10 pc. / 50 pc.	16x1/2"
2PK-1804BP	10 pc. / 50 pc.	18x1/2"
2PK-2004BP	10 pc. / 50 pc.	20x1/2"
2PK-2005	5 pc. / 30 pc.	20x3/4"
2PK-2605	5 pc. / 30 pc.	26x3/4"

Type: 2PK-X (INOX 316 L)



Backplate elbow female Inox
Sanitair muurplaat binnendraad Inox
Culasse pour sanitaire Inox
Sanitär Wandscheibe IG Inox

Article number	Bag / Box	Type
2PK-1404-X	10 pc. / 50 pc.	14x1/2"
2PK-1604-X	10 pc. / 50 pc.	16x1/2"
2PK-1804-X	10 pc. / 50 pc.	18x1/2"
2PK-2004-X	10 pc. / 50 pc.	20x1/2"
2PK-2005-X	5 pc. / 30 pc.	20x3/4"
2PK-2605-X	5 pc. / 30 pc.	26x3/4"



Did you know you could use our galvanised bracket plates for the 2PK, 2PK-X and 2PK-K fittings?

> Find more information on **p. 161**

Type: 2PK-K (CW617)



Backplate elbow female, short model
Sanitair muurplaat binnendraad, laag
Culasse double pour sanitaire, modèle court
Sanitär Wandscheibe IG, kurzes Modell

Article number	Bag / Box	Type
2PK-1604KBP	10 pc. / 50 pc.	16x1/2"

Type: 3PK (CW617)



Double backplate elbow female, short model
Sanitair muurplaat binnendraad dubbel, laag
Culasse double pour sanitaire, modèle court
Sanitär Wandscheibe doppelt IG, kurzes Modell

Article number	Bag / Box	Type
3PK-160416BP	10 pc. / 30 pc.	16x1/2"x16
3PK-200420BP	10 pc. / 30 pc.	20x1/2"x20

Type: 3PK-X (INOX 316 L)



Double backplate elbow female, short model INOX
Sanitair muurplaat binnendraad dubbel INOX
Culasse double pour sanitaire, modèle court INOX
Sanitär Wandscheibe doppelt IG, kurzes Modell INOX

Article number	Bag / Box	Type
3PK-160416-X	10 pc. / 30 pc.	16x1/2"x16 (40 mm)
3PK-200420-X	10 pc. / 30 pc.	20x1/2"x20 (40 mm)

Type: BP04



Black plug for 1/2" backplate
Zwarte stop voor 1/2" muurplaat
Bouchon noir pour 1/2" culasse
Schwarzen Stopf für 1/2" Wandscheibe

Article number	Bag / Box	Type
BP04	50 pc. / 500 pc.	1/2"

Not suited for testing



Henco Synthetic Press

Henco Press BLACK - PK

1

2

3

4

5



Did you know you could use the PK-tool wrench for PK and SK fittings to realise an even quicker installation of threaded Henco fittings.

> Find more information on **p. 156**

6

7

8

9

10

11

12

Type: 5PK (CW617) 



Elbow 90° male adapter

Knie 90° buitendraad

Coude 90° mâle

Winkel 90° AG

Article number	Bag / Box	Type
5PK-1404	10 pc. / 60 pc.	14x1/2"
5PK-1604	10 pc. / 60 pc.	16x1/2"
5PK-1804	10 pc. / 60 pc.	18x1/2"
5PK-2004	10 pc. / 60 pc.	20x1/2"
5PK-2005	10 pc. / 50 pc.	20x3/4"
5PK-2605	10 pc. / 40 pc.	26x3/4"
5PK-3206	5 pc. / 20 pc.	32x1"
5PK-4007	3 pc. / 15 pc.	40x5/4"
5PK-5007	1 pc. / 10 pc.	50x5/4"
5PK-5008	1 pc. / 8 pc.	50x6/4"
5PK-6310	1 pc. / 4 pc.	63x2"

Type: 5PK-N (CW602) 



Elbow 90° male adapter CW602

Knie 90° buitendraad CW602

Coude 90° mâle CW602

Winkel 90° AG CW602

Article number	Bag / Box	Type
5PK-4007-N	3 pc. / 15 pc.	40x5/4"
5PK-5007-N	1 pc. / 10 pc.	50x5/4"
5PK-5008-N	1 pc. / 8 pc.	50x6/4"
5PK-6310-N	1 pc. / 4 pc.	63x2"

Type: 6PK (CW617) 



Elbow 90° female adapter

Knie 90° binnendraad

Coude 90° femelle

Winkel 90° IG

Article number	Bag / Box	Type
6PK-1404BP	10 pc. / 60 pc.	14x1/2"
6PK-1603	10 pc. / 60 pc.	16x3/8"
6PK-1604BP	10 pc. / 60 pc.	16x1/2"
6PK-1804BP	10 pc. / 60 pc.	18x1/2"
6PK-2004BP	10 pc. / 60 pc.	20x1/2"
6PK-2005	10 pc. / 50 pc.	20x3/4"
6PK-2605	10 pc. / 50 pc.	26x3/4"
6PK-3206	5 pc. / 20 pc.	32x1"
6PK-4007	5 pc. / 15 pc.	40x5/4"
6PK-5007	1 pc. / 8 pc.	50x5/4"
6PK-5008	1 pc. / 8 pc.	50x6/4"
6PK-6310	1 pc. / 4 pc.	63x2"



Diameter 75mm / 90mm **SUPERSIZES p. 53**

Type: 6PK-X (INOX 316 L) 



Elbow 90° female adapter INOX
Knie 90° binnendraad INOX
Coude 90° femelle INOX
Winkel 90° IG INOX

Article number	Bag / Box	Type
6PK-1404-X	10 pc. / 60 pc.	14x1/2"
6PK-1604-X	10 pc. / 60 pc.	16x1/2"
6PK-1804-X	10 pc. / 60 pc.	18x1/2"
6PK-2004-X	10 pc. / 60 pc.	20x1/2"
6PK-2005-X	10 pc. / 50 pc.	20x3/4"
6PK-2605-X	10 pc. / 50 pc.	26x3/4"
6PK-3206-X	5 pc. / 20 pc.	32x1"
6PK-4007-X	5 pc. / 15 pc.	40x1 1/4"
6PK-5007-X	1 pc. / 8 pc.	50x1 1/4"
6PK-5008-X	1 pc. / 8 pc.	50x1 1/2"
6PK-6310-X	1 pc. / 4 pc.	63x2"

Type: 6PK-N (CW602) 



Elbow 90° female adapter CW602
Knie 90° binnendraad CW602
Coude 90° femelle CW602
Winkel 90° IG CW602

Article number	Bag / Box	Type
6PK-4007-N	5 pc. / 15 pc.	40x5/4"
6PK-5007-N	1 pc. / 8 pc.	50x5/4"
6PK-5008-N	1 pc. / 8 pc.	50x6/4"
6PK-6310-N	1 pc. / 4 pc.	63x2"

Type: 9PK



T-piece
T-stuk
Pièce en T
T-Stück

Article number	Bag / Box	Type
9PK-141414	10 pc. / 100 pc.	14x14x14
9PK-161616	10 pc. / 60 pc.	16x16x16
9PK-181818	10 pc. / 60 pc.	18x18x18
9PK-202020	10 pc. / 50 pc.	20x20x20
9PK-262626	5 pc. / 30 pc.	26x26x26
9PK-323232	5 pc. / 15 pc.	32x32x32
9PK-404040	5 pc. / 10 pc.	40x40x40
9PK-505050	1 pc. / 6 pc.	50x50x50
9PK-636363	1 pc. / 3 pc.	63x63x63

- 1
- 2
- 3
- 4
- 5
- 6
- 7
- 8
- 9
- 10
- 11
- 12



Henco Synthetic Press

Henco Press BLACK - PK

Type: 10PK



T-reduced centre

T-verlopend

Pièce en T réduit

T-reduziert

Article number	Bag / Box	Type
10PK-161416	10 pc. / 50 pc.	16x14x16
10PK-181418	10 pc. / 50 pc.	18x14x18
10PK-181618	10 pc. / 50 pc.	18x16x18
10PK-201420	10 pc. / 50 pc.	20x14x20
10PK-201620	10 pc. / 50 pc.	20x16x20
10PK-201820	10 pc. / 50 pc.	20x18x20
10PK-261626	5 pc. / 30 pc.	26x16x26
10PK-261826	5 pc. / 30 pc.	26x18x26
10PK-262026	5 pc. / 30 pc.	26x20x26
10PK-321632	5 pc. / 25 pc.	32x16x32
10PK-321832	5 pc. / 25 pc.	32x18x32
10PK-322032	5 pc. / 25 pc.	32x20x32
10PK-322632	5 pc. / 20 pc.	32x26x32
10PK-401640	5 pc. / 15 pc.	40x16x40
10PK-402040	5 pc. / 15 pc.	40x20x40
10PK-402640	5 pc. / 15 pc.	40x26x40
10PK-403240	5 pc. / 10 pc.	40x32x40
10PK-502050	1 pc. / 6 pc.	50x20x50
10PK-502650	1 pc. / 8 pc.	50x26x50
10PK-503250	1 pc. / 8 pc.	50x32x50
10PK-504050	1 pc. / 6 pc.	50x40x50
10PK-632663	1 pc. / 4 pc.	63x26x63
10PK-633263	1 pc. / 3 pc.	63x32x63
10PK-634063	1 pc. / 3 pc.	63x40x63
10PK-635063	1 pc. / 3 pc.	63x50x63

Type: 10PK-JG



T-reduced centre (ceiling cooling)

T-verlopend (koelplafond)

Pièce en T-réduit (plafond climatisé)

T-reduziert (Klimadecke)

Article number	Bag / Box	Type
10PK-20JG1020	10 pc. / 50 pc.	20x10JGx20



Diameter 75mm / 90mm **SUPERSIZES p. 53**

Type: 11PK



T-branch and line reduced

T-2x verlopend

Pièce en T 2x réduit

T-2x reduziert

Article number	Bag / Box	Type
11PK-161414	10 pc. / 50 pc.	16x14x14
11PK-181616	10 pc. / 50 pc.	18x16x16
11PK-201616	10 pc. / 50 pc.	20x16x16
11PK-201818	10 pc. / 50 pc.	20x18x18
11PK-202016	10 pc. / 50 pc.	20x20x16
11PK-261616	10 pc. / 50 pc.	26x16x16
11PK-261620	5 pc. / 30 pc.	26x16x20
11PK-262016	5 pc. / 30 pc.	26x20x16
11PK-262020	5 pc. / 30 pc.	26x20x20
11PK-262616	5 pc. / 30 pc.	26x26x16
11PK-262620	5 pc. / 30 pc.	26x26x20
11PK-322026	5 pc. / 20 pc.	32x20x26
11PK-322626	5 pc. / 20 pc.	32x26x26
11PK-402032	5 pc. / 15 pc.	40x20x32
11PK-402632	5 pc. / 15 pc.	40x26x32
11PK-403232	5 pc. / 10 pc.	40x32x32
11PK-404026	5 pc. / 10 pc.	40x40x26
11PK-404032	5 pc. / 10 pc.	40x40x32
11PK-502040	1 pc. / 10 pc.	50x20x40
11PK-502640	1 pc. / 10 pc.	50x26x40
11PK-503240	1 pc. / 10 pc.	50x32x40
11PK-504040	1 pc. / 8 pc.	50x40x40

Type: 12PK



T-enlarged branch

T-vergroot

Pièce en T agrandi

T-erweitert

Article number	Bag / Box	Type
12PK-161816	10 pc. / 50 pc.	16x18x16
12PK-162016	10 pc. / 50 pc.	16x20x16
12PK-202620	5 pc. / 30 pc.	20x26x20
12PK-263226	5 pc. / 20 pc.	26x32x26
12PK-324032	5 pc. / 15 pc.	32x40x32
12PK-405040	1 pc. / 8 pc.	40x50x40



Henco Synthetic Press

Henco Press BLACK - PK

Type: 13PK

1

2

3

4

5

6

7

8

9

10

11

12



T-female centre

T-binnendraad

Pièce en T femelle

T-IG

Article number	Bag / Box	Type
13PK-160416BP	10 pc. / 50 pc.	16x1/2"x16
13PK-180418BP	10 pc. / 50 pc.	18x1/2"x18
13PK-200420BP	10 pc. / 50 pc.	20x1/2"x20
13PK-200520	10 pc. / 30 pc.	20x3/4"x20
13PK-260420BP	5 pc. / 30 pc.	26x1/2"x20
13PK-260426BP	5 pc. / 30 pc.	26x1/2"x26
13PK-260526	5 pc. / 30 pc.	26x3/4"x26
13PK-320532	5 pc. / 15 pc.	32x3/4"x32
13PK-320632	5 pc. / 10 pc.	32x1"x32
13PK-320732	5 pc. / 10 pc.	32x5/4"x32
13PK-400540	5 pc. / 10 pc.	40x3/4"x40
13PK-400640	5 pc. / 10 pc.	40x1"x40
13PK-400740	5 pc. / 10 pc.	40x5/4"x40
13PK-500550	1 pc. / 6 pc.	50x3/4"x50
13PK-500850	1 pc. / 4 pc.	50x6/4"x50
13PK-631063	1 pc. / 2 pc.	63x2"x63

Type: 13PK-X (INOX 316 L)



T-female centre INOX

T-binnendraad INOX

Pièce en T femelle INOX

T-IG INOX

Article number	Bag / Box	Type
13PK-160416-X	10 pc. / 50 pc.	16x1/2"x16
13PK-180418-X	10 pc. / 50 pc.	18x1/2"x18
13PK-200420-X	10 pc. / 50 pc.	20x1/2"x20
13PK-200520-X	10 pc. / 30 pc.	20x3/4"x20
13PK-260420-X	5 pc. / 30 pc.	26x1/2"x20
13PK-260426-X	5 pc. / 30 pc.	26x1/2"x26
13PK-260526-X	5 pc. / 30 pc.	26x3/4"x26
13PK-320532-X	5 pc. / 15 pc.	32x3/4"x32
13PK-320632-X	5 pc. / 10 pc.	32x1"x32
13PK-320732-X	5 pc. / 10 pc.	32x5/4"x32
13PK-400540-X	5 pc. / 10 pc.	40x3/4"x40
13PK-400640-X	5 pc. / 10 pc.	40x1"x40
13PK-400740-X	5 pc. / 10 pc.	40x5/4"x40
13PK-500550-X	1 pc. / 6 pc.	50x3/4"x50
13PK-500850-X	1 pc. / 4 pc.	50x6/4"x50
13PK-631063-X	1 pc. / 2 pc.	63x2"x63

Type: 13PK-N (CW602)



T-female centre CW602

T-binnendraad CW602

Pièce en T femelle CW602

T-IG CW602

Article number	Bag / Box	Type
13PK-400540-N	5 pc. / 10 pc.	40x3/4"x40
13PK-400640-N	5 pc. / 10 pc.	40x1"x40
13PK-400740-N	5 pc. / 10 pc.	40x5/4"x40
13PK-500550-N	1 pc. / 6 pc.	50x3/4"x50
13PK-500850-N	1 pc. / 4 pc.	50x6/4"x50
13PK-631063-N	1 pc. / 2 pc.	63x2"x63



Diameter 75mm / 90mm **SUPERSIZES p. 53**



Did you know you could use the PK-tool wrench for PK and SK fittings to realise an even quicker installation of threaded Henco fittings.

> Find more information on **p. 156**

Type: 14PK (CW617) 



T-male centre
T-buitendraad
Pièce en T mâle
T-AG

Article number	Bag / Box	Type
14PK-160416	10 pc. / 50 pc.	16x1/2"x16
14PK-180418	10 pc. / 50 pc.	18x1/2"x18
14PK-200420	10 pc. / 40 pc.	20x1/2"x20
14PK-200520	10 pc. / 30 pc.	20x3/4"x20
14PK-260426	5 pc. / 30 pc.	26x1/2"x26
14PK-260526	5 pc. / 25 pc.	26x3/4"x26
14PK-260626	5 pc. / 20 pc.	26x1"x26
14PK-320532	5 pc. / 15 pc.	32x3/4"x32
14PK-400640	5 pc. / 10 pc.	40x1"x40
14PK-400740	5 pc. / 10 pc.	40x5/4"x40
14PK-500850	1 pc. / 5 pc.	50x6/4"x50
14PK-631063	1 pc. / 2 pc.	63x2"x63

Type: 14PK-N (CW602) 



T-male centre CW602
T-buitendraad CW602
Pièce en T mâle CW602
T-AG CW602

Article number	Bag / Box	Type
14PK-400640-N	5 pc. / 10 pc.	40x1"x40
14PK-400740-N	5 pc. / 10 pc.	40x5/4"x40
14PK-500850-N	1 pc. / 5 pc.	50x6/4"x50
14PK-631063-N	1 pc. / 2 pc.	63x2"x63

Type: 15PK



Straight coupling
Perssok
Manchon
Kupplung

Article number	Bag / Box	Type
15PK-1414	10 pc. / 150 pc.	14x14
15PK-1616	10 pc. / 150 pc.	16x16
15PK-1818	10 pc. / 100 pc.	18x18
15PK-2020	10 pc. / 80 pc.	20x20
15PK-2626	5 pc. / 50 pc.	26x26
15PK-3232	5 pc. / 30 pc.	32x32
15PK-4040	5 pc. / 25 pc.	40x40
15PK-5050	1 pc. / 12 pc.	50x50
15PK-6363	1 pc. / 9 pc.	63x63

- 1
- 2
- 3
- 4
- 5
- 6
- 7
- 8
- 9
- 10
- 11
- 12



Henco Synthetic Press

Henco Press BLACK - PK

Type: 16PK



Reducing coupling
Verloopstuk
Réduction
Kupplung-reduziert

Article number	Bag / Box	Type
16PK-1614	10 pc. / 100 pc.	16x14
16PK-1814	10 pc. / 100 pc.	18x14
16PK-1816	10 pc. / 100 pc.	18x16
16PK-2014	10 pc. / 100 pc.	20x14
16PK-2016	10 pc. / 100 pc.	20x16
16PK-2018	10 pc. / 100 pc.	20x18
16PK-2616	5 pc. / 60 pc.	26x16
16PK-2618	5 pc. / 50 pc.	26x18
16PK-2620	5 pc. / 50 pc.	26x20
16PK-3216	5 pc. / 50 pc.	32x16
16PK-3220	5 pc. / 40 pc.	32x20
16PK-3226	5 pc. / 40 pc.	32x26
16PK-4026	5 pc. / 30 pc.	40x26
16PK-4032	5 pc. / 25 pc.	40x32
16PK-5032	1 pc. / 15 pc.	50x32
16PK-5040	1 pc. / 15 pc.	50x40
16PK-6340	1 pc. / 8 pc.	63x40
16PK-6350	1 pc. / 8 pc.	63x50

Type: 17PK (CW617)



Straight male adapter
Puntstuk
Raccord droit mâle
Übergangsfitting AG

Article number	Bag / Box	Type
17PK-1404	10 pc. / 80 pc.	14x1/2"
17PK-1604	10 pc. / 80 pc.	16x1/2"
17PK-1804	10 pc. / 80 pc.	18x1/2"
17PK-1805	10 pc. / 50 pc.	18x3/4"
17PK-2004	10 pc. / 80 pc.	20x1/2"
17PK-2005	10 pc. / 50 pc.	20x3/4"
17PK-2605	10 pc. / 50 pc.	26x3/4"
17PK-2606	10 pc. / 40 pc.	26x1"
17PK-3206	10 pc. / 40 pc.	32x1"
17PK-3207	5 pc. / 25 pc.	32x5/4"
17PK-4006	5 pc. / 25 pc.	40x1"
17PK-4007	5 pc. / 25 pc.	40x5/4"
17PK-5008	1 pc. / 10 pc.	50x6/4"
17PK-6310	1 pc. / 6 pc.	63x2"

Type: 17PK-N (CW602)



Straight male adapter CW602
Puntstuk CW602
Raccord droit mâle CW602
Übergangsfitting AG CW602

Article number	Bag / Box	Type
17PK-4006-N	5 pc. / 25 pc.	40x1"
17PK-4007-N	5 pc. / 25 pc.	40x5/4"
17PK-5008-N	1 pc. / 10 pc.	50x6/4"
17PK-6310-N	1 pc. / 6 pc.	63x2"



Diameter 75mm / 90mm **SUPERSIZES p. 53**



Did you know you could use the PK-tool wrench for PK and SK fittings to realise an even quicker installation of threaded Henco fittings.

> Find more information on **p. 156**

Type: 18PK (CW617) 



Straight female adapter
Schroefbus
Raccord droit femelle
Übergangsfitting IG

Article number	Bag / Box	Type
18PK-1404	10 pc. / 80 pc.	14x1/2"
18PK-1604	10 pc. / 80 pc.	16x1/2"
18PK-1804	10 pc. / 80 pc.	18x1/2"
18PK-1805	10 pc. / 50 pc.	18x3/4"
18PK-2004	10 pc. / 80 pc.	20x1/2"
18PK-2005	10 pc. / 50 pc.	20x3/4"
18PK-2605	10 pc. / 50 pc.	26x3/4"
18PK-2606	10 pc. / 40 pc.	26x1"
18PK-3206	10 pc. / 40 pc.	32x1"
18PK-3207	5 pc. / 25 pc.	32x5/4"
18PK-4006	5 pc. / 25 pc.	40x1"
18PK-4007	5 pc. / 25 pc.	40x5/4"
18PK-5008	1 pc. / 10 pc.	50x6/4"
18PK-6310	1 pc. / 6 pc.	63x2"

Type: 18PK-X (INOX 316 L) 



Straight female adapter INOX
Schroefbus INOX
Raccord droit femelle INOX
Übergangsfitting IG INOX

Article number	Bag / Box	Type
18PK-1604-X	10 pc. / 80 pc.	16x1/2"
18PK-1804-X	10 pc. / 80 pc.	18x1/2"
18PK-1805-X	10 pc. / 50 pc.	18x3/4"
18PK-2004-X	10 pc. / 80 pc.	20x1/2"
18PK-2005-X	10 pc. / 50 pc.	20x3/4"
18PK-2605-X	10 pc. / 50 pc.	26x3/4"
18PK-2606-X	10 pc. / 40 pc.	26x1"
18PK-3206-X	10 pc. / 40 pc.	32x1"
18PK-3207-X	5 pc. / 25 pc.	32x1 1/4"
18PK-4006-X	5 pc. / 25 pc.	40x1"
18PK-4007-X	5 pc. / 25 pc.	40x1 1/4"
18PK-5008-X	1 pc. / 10 pc.	50x1 1/2"
18PK-6310-X	1 pc. / 6 pc.	63x2"

- 1
- 2
- 3
- 4
- 5
- 6
- 7
- 8
- 9
- 10
- 11
- 12



Henco Synthetic Press

Henco Press BLACK - PK

1

Type: 18PK-N (CW602)

2



Straight female adapter CW602
Schroefbus CW602
Raccord droit femelle CW602
Übergangsfitting IG CW602

Article number	Bag / Box	Type
18PK-4006-N	5 pc. / 25 pc.	40x1"
18PK-4007-N	5 pc. / 25 pc.	40x5/4"
18PK-5008-N	1 pc. / 10 pc.	50x6/4"
18PK-6310-N	1 pc. / 6 pc.	63x2"

3

4

5

6

7

Type: 19PK

8



Press fit with swivel to eurocone
Perskoppeling met wartel en euroconus aansluiting
Raccord à sertir avec ecrou à visser eurocone
Pressfitting mit Drehbar und Eurokonus

Article number	Bag / Box	Type
19PK-1605	10 pc. / 80 pc.	16x3/4" EK
19PK-2005	10 pc. / 80 pc.	20x3/4" EK

9

10

11

12

Type: 26PK



Press fitting with swivel and flat sealing
Perskoppeling met wartel en vlakke dichting
Raccord avec ecrou et joint plat
Pressfitting mit Drehbar und flach Versiegelung

Article number	Bag / Box	Type
26PK-1605	10 pc. / 80 pc.	16x3/4
26PK-2005	10 pc. / 80 pc.	20x3/4

Type: 26PK (CW617)



Press fitting with swivel and flat sealing
Perskoppeling met wartel en vlakke dichting
Raccord avec ecrou et joint plat
Pressfitting mit Drehbar und flach Versiegelung

Article number	Bag / Box	Type
26PK-4007	5 pc. / 15 pc.	40x5/4"
26PK-4008	5 pc. / 15 pc.	40x1 1/2"
26PK-5008	1 pc. / 10 pc.	50x6/4"
26PK-5010	1 pc. / 10 pc.	50x2"
26PK-6310	1 pc. / 6 pc.	63x2"
26PK-6312	1 pc. / 6 pc.	63x2 1/2"



Diameter 75mm / 90mm **SUPERSIZES p. 53**

Type: 27PK



Elbow 45°
Knie 45°
Coude 45°
Winkel 45°

Article number	Bag / Box	Type
27PK-2626	5 pc. / 50 pc.	26x26
27PK-3232	5 pc. / 30 pc.	32x32
27PK-4040	5 pc. / 25 pc.	40x40
27PK-5050	1 pc. / 10 pc.	50x50
27PK-6363	1 pc. / 5 pc.	63x63

Type: 28PK-04



Bracket wallplate for 2PK, 6PK and 13PK, interaxis 153 mm
Muurplaatbeugel voor 2PK, 6PK en 13PK, interaxis 153 mm
Attache culasse pour 2PK, 6PK et 13PK, entraxe 153 mm
Bügel Wandscheibe für 2PK, 6PK und 13PK, Mitte-zu-Mitte-Abstand 153 mm

Article number	Bag / Box	Type
28PK-04	1 pc. / 50 pc.	1/2" PK Backplate

Type: 53PK



Easy mounting fitting
Eenvoudige montage fitting
Raccord montage facile
Einfache Montage Fitting

Article number	Bag / Box	Type
53PK40	1 pc. / 20 pc.	40x40
53PK50	1 pc. / 9 pc.	50x50
53PK63	1 pc. / 6 pc.	63x63

for Ø16, 20, 26 and 32, see chapter 4 article 52P

Type: N-X (INOX 316 L)



INOX nipple
INOX nippel
Nipple INOX
INOX-nippel

Article number	Bag	Type
N0404-X	10 pc.	1/2" x 1/2"
N0505-X	10 pc.	3/4" x 3/4"
N0606-X	10 pc.	1" x 1"



Henco Synthetic Press

Henco Press WHITE - PKW

Type: 1PKW



Elbow 90°

Knie 90°

Coude 90°

Winkel 90°

Article number	Bag / Box	Type
1PKW-1616	10 pc. / 120 pc.	16x16
1PKW-2020	10 pc. / 80 pc.	20x20
1PKW-2626	5 pc. / 50 pc.	26x26
1PKW-3232	5 pc. / 30 pc.	32x32

Type: 2PKW (CW617)



Backplate elbow female

Sanitair muurplaat binnendraad

Culasse pour sanitaire

Sanitär Wandscheibe IG

Article number	Bag / Box	Type
2PKW-1604	10 pc. / 50 pc.	16x1/2" (56 mm)
2PKW-2004	10 pc. / 50 pc.	20x1/2" (56 mm)
2PKW-2005	5 pc. / 30 pc.	20x3/4" (56 mm)
2PKW-2605	5 pc. / 30 pc.	26x3/4" (56 mm)

Type: 2PKW-X (INOX 316 L)



Backplate elbow female INOX

Sanitair muurplaat binnendraad INOX

Culasse pour sanitaire INOX

Backplate elbow female INOX

Article number	Bag / Box	Type
2PKW-1604-X	10 pc. / 50 pc.	16x1/2" (56 mm)
2PKW-2004-X	10 pc. / 50 pc.	20x1/2" (56 mm)
2PKW-2005-X	5 pc. / 30 pc.	20x3/4" (56 mm)
2PKW-2605-X	5 pc. / 30 pc.	26x3/4" (56 mm)

Type: 2PKW-N (CW602)



Backplate elbow female CW602

Sanitair muurplaat binnendraad CW602

Culasse pour sanitaire CW602

Sanitär Wandscheibe IG CW602

Article number	Bag / Box	Type
2PKW-1604-N	10 pc. / 50 pc.	16x1/2" (56 mm)
2PKW-2004-N	10 pc. / 50 pc.	20x1/2" (56 mm)
2PKW-2005-N	5 pc. / 30 pc.	20x3/4" (56 mm)
2PKW-2605-N	5 pc. / 30 pc.	26x3/4" (56 mm)



1

2

3

4

5

6

7

8

9

10

11

12



Did you know you could use our galvanised bracket plates for the 2PKW, 2PKW-N, 2PKW-X, 2PKW-K, 2PKW-K-N and 2PKW-K-N fittings?

> Find more information on **p. 161**

Type: 2PKW-K (CW617)



Backplate elbow female, short model
Sanitair muurplaat binnendraad, laag
Culasse pour sanitaire, modèle court
Sanitär Wandscheibe IG, kurzes Modell

Article number	Bag / Box	Type
2PKW-1604K	10 pc. / 50 pc.	16x1/2" (40 mm)

Type: 2PKW-K-X (INOX 316 L)



Backplate elbow female, short model INOX
Sanitair muurplaat binnendraad, laag INOX
Culasse pour sanitaire, modèle court INOX
Sanitär Wandscheibe IG, kurzes Modell INOX

Article number	Bag / Box	Type
2PKW-1604K-X	10 pc. / 50 pc.	16x1/2" (40 mm)

Type: 2PKW-K-N (CW602)



Backplate elbow female, short model CW602
Sanitair muurplaat binnendraad, laag, CW602
Culasse pour sanitaire, modèle court CW602
Sanitär Wandscheibe IG, kurzes Modell CW602

Article number	Bag / Box	Type
2PKW-1604K-N	10 pc. / 50 pc.	16x1/2" (40 mm)

Type: 3PKW (CW617)



Double backplate elbow female, short model
Sanitair muurplaat binnendraad dubbel, laag
Coude double plaque arrière femelle, modèle court
Sanitär Wandscheibe doppelt IG, kurzes Modell

Article number	Bag / Box	Type
3PKW-160416	10 pc. / 30 pc.	16x1/2"x16 (40 mm)
3PKW-200420	10 pc. / 30 pc.	20x1/2"x20 (40 mm)



Henco Synthetic Press

Henco Press WHITE - PKW

Type: 3PKW-X (INOX 316 L)



Double backplate elbow female, short model INOX
 Sanitair muurplaat binnendraad dubbel, laag INOX
 Coude double plaque arrière femelle, modèle court INOX
 Sanitär Wandscheibe doppelt IG, kurzes Modell INOX

Article number	Bag / Box	Type
3PKW-160416-X	10 pc. / 30 pc.	16x1/2"x16 (40 mm)
3PKW-200420-X	10 pc. / 30 pc.	20x1/2"x20 (40 mm)

Type: 3PKW-N (CW602)



Double backplate elbow female, short model CW602
 Sanitair muurplaat binnendraad dubbel, laag CW602
 Coude double plaque arrière femelle, modèle court CW602
 Sanitär Wandscheibe doppelt IG, kurzes Modell CW602

Article number	Bag / Box	Type
3PKW-160416-N	10 pc. / 30 pc.	16x1/2"x16 (40 mm)
3PKW-200420-N	10 pc. / 30 pc.	20x1/2"x20 (40 mm)

Type: 5PKW (CW617)



Elbow 90° male adapter
 Knie 90° buitendraad
 Coude 90° mâle
 Winkel 90° AG

Article number	Bag / Box	Type
5PKW-1604	10 pc. / 60 pc.	16x1/2"
5PKW-2004	10 pc. / 60 pc.	20x1/2"
5PKW-2005	10 pc. / 50 pc.	20x3/4"
5PKW-2605	10 pc. / 40 pc.	26x3/4"
5PKW-3206	5 pc. / 20 pc.	32x1"

Type: 5PKW-N (CW602)



Elbow 90° male adapter CW602
 Knie 90° buitendraad CW602
 Coude 90° mâle CW602
 Winkel 90° AG CW602

Article number	Bag / Box	Type
5PKW-1604-N	10 pc. / 60 pc.	16x1/2"
5PKW-2004-N	10 pc. / 60 pc.	20x1/2"
5PKW-2005-N	10 pc. / 50 pc.	20x3/4"
5PKW-2605-N	10 pc. / 40 pc.	26x3/4"
5PKW-3206-N	5 pc. / 20 pc.	32x1"

Type: 6PKW (CW617)



Elbow 90° female adapter
 Knie 90° binnendraad
 Coude 90° femelle
 Winkel 90° IG

Article number	Bag / Box	Type
6PKW-1603	10 pc. / 60 pc.	16x3/8"
6PKW-1604	10 pc. / 60 pc.	16x1/2"
6PKW-2004	10 pc. / 60 pc.	20x1/2"
6PKW-2005	10 pc. / 50 pc.	20x3/4"
6PKW-2605	10 pc. / 50 pc.c	26x3/4"
6PKW-3206	5 pc. / 20 pc.	32x1"



Did you know you could use the PK-tool wrench for PK and SK fittings to realise an even quicker installation of threaded Henco fittings.

> Find more information on **p. 156**

Type: 6PKW-X (INOX 316 L) 



Elbow 90° female adapter INOX
Knie 90° binnendraad INOX
Coude 90° femelle INOX
Winkel 90° IG INOX

Article number	Bag / Box	Type
6PKW-1604-X	10 pc. / 60 pc.	16x1/2"
6PKW-2004-X	10 pc. / 60 pc.	20x1/2"
6PKW-2005-X	10 pc. / 50 pc.	20x3/4"
6PKW-2605-X	10 pc. / 50 pc.	26x3/4"
6PKW-3206-X	5 pc. / 20 pc.	32x1"

Type: 6PKW-N (CW602) 



Elbow 90° female adapter CW602
Knie 90° binnendraad CW602
Coude 90° femelle CW602
Winkel 90° IG CW602

Article number	Bag / Box	Type
6PKW-1603-N	10 pc. / 60 pc.	16x3/8"
6PKW-1604-N	10 pc. / 60 pc.	16x1/2"
6PKW-2004-N	10 pc. / 60 pc.	20x1/2"
6PKW-2005-N	10 pc. / 50 pc.	20x3/4"
6PKW-2605-N	10 pc. / 50 pc.	26x3/4"
6PKW-3206-N	5 pc. / 20 pc.	32x1"

Type: 9PKW



T-piece
T-stuk
Pièce en T
T-Stück

Article number	Bag / Box	Type
9PKW-161616	10 pc. / 60 pc.	16x16x16
9PKW-202020	10 pc. / 50 pc.	20x20x20
9PKW-262626	5 pc. / 30 pc.	26x26x26
9PKW-323232	5 pc. / 15 pc.	32x32x32

Type: 10PKW



T-reduced centre
T-verlopend
Pièce en T réduit
T-reduziert

Article number	Bag / Box	Type
10PKW-201620	10 pc. / 50 pc.	20x16x20
10PKW-261626	5 pc. / 30 pc.	26x16x26
10PKW-262026	5 pc. / 30 pc.	26x20x26
10PKW-321632	5 pc. / 25 pc.	32x16x32
10PKW-322032	5 pc. / 25 pc.	32x20x32
10PKW-322632	5 pc. / 20 pc.	32x26x32





Henco Synthetic Press

Henco Press WHITE - PKW

Type: 11PKW



T-branch and line reduced

T-2x verlopend

T-2x réduit

T-2x reduziert

Article number	Bag / Box	Type
11PKW-201616	10 pc. / 50 pc.	20x16x16
11PKW-202016	10 pc. / 50 pc.	20x20x16
11PKW-261616	10 pc. / 50 pc.	26x16x16
11PKW-261620	5 pc. / 30 pc.	26x16x20
11PKW-262016	5 pc. / 30 pc.	26x20x16
11PKW-262020	5 pc. / 30 pc.	26x20x20
11PKW-262616	5 pc. / 30 pc.	26x26x16
11PKW-262620	5 pc. / 30 pc.	26x26x20
11PKW-322026	5 pc. / 20 pc.	32x20x26
11PKW-322626	5 pc. / 20 pc.	32x26x26

Type: 12PKW



T-enlarged branch

T-vergroot

T-agrandi

T-erweitert

Article number	Bag / Box	Type
12PKW-162016	10 pc. / 50 pc.	16x20x16
12PKW-202620	5 pc. / 30 pc.	20x26x20
12PKW-263226	5 pc. / 20 pc.	26x32x26

Type: 13PKW (CW617)



T-female centre

T-binnendraad

T-femelle

T-IG

Article number	Bag / Box	Type
13PKW-160416	10 pc. / 50 pc.	16x1/2"x16
13PKW-200420	10 pc. / 50 pc.	20x1/2"x20
13PKW-200520	10 pc. / 30 pc.	20x3/4"x20
13PKW-260426	5 pc. / 30 pc.	26x1/2"x26
13PKW-260526	5 pc. / 30 pc.	26x3/4"x26
13PKW-320532	5 pc. / 15 pc.	32x3/4"x32
13PKW-320632	5 pc. / 10 pc.	32x1"x32



Did you know you could use the PK-tool wrench for PK and SK fittings to realise an even quicker installation of threaded Henco fittings.

> Find more information on **p. 156**

Type: 13PKW-X (INOX 316 L) 



T-female centre INOX
T-binnendraad INOX
T-femelle INOX
T-IG INOX

Article number	Bag / Box	Type
13PKW-160416-X	10 pc. / 50 pc.	16x1/2"x16
13PKW-200420-X	10 pc. / 50 pc.	20x1/2"x20
13PKW-200520-X	10 pc. / 30 pc.	20x3/4"x20
13PKW-260426-X	5 pc. / 30 pc.	26x1/2"x26
13PKW-260526-X	5 pc. / 30 pc.	26x3/4"x26
13PKW-320532-X	5 pc. / 15 pc.	32x3/4"x32
13PKW-320632-X	5 pc. / 10 pc.	32x1"x32

Type: 13PKW-N (CW602) 



T-female centre CW602
T-binnendraad CW602
T-femelle CW602
T-IG CW602

Article number	Bag / Box	Type
13PKW-160416-N	10 pc. / 50 pc.	16x1/2"x16
13PKW-200420-N	10 pc. / 50 pc.	20x1/2"x20
13PKW-200520-N	10 pc. / 30 pc.	20x3/4"x20
13PKW-260426-N	5 pc. / 30 pc.	26x1/2"x26
13PKW-260526-N	5 pc. / 30 pc.	26x3/4"x26
13PKW-320532-N	5 pc. / 15 pc.	32x3/4"x32
13PKW-320632-N	5 pc. / 10 pc.	32x1"x32

1

2

3

4

5

6

7

8

9

10

11

12



Henco Synthetic Press

Henco Press WHITE - PKW

1

2

3

4

5

6

7

8

9

10

11

12

Type: 14PKW (CW617)



T-male centre CW617
T-buitendraad CW617
T-mâle CW617
T-AG CW617

Article number	Bag / Box	Type
14PKW-160416	10 pc. / 50 pc.	16x1/2"x16
14PKW-200420	10 pc. / 40 pc.	20x1/2"x20
14PKW-200520	10 pc. / 30 pc.	20x3/4"x20
14PKW-320532	5 pc. / 15 pc.	32x3/4"x32

Type: 14PKW-N (CW602)



T-male centre CW602
T-buitendraad CW602
T-mâle CW602
T-AG CW602

Article number	Bag / Box	Type
14PKW-160416-N	10 pc. / 50 pc.	16x1/2"x16
14PKW-200420-N	10 pc. / 40 pc.	20x1/2"x20
14PKW-200520-N	10 pc. / 30 pc.	20x3/4"x20

Type: 15PKW



Straight coupling
Doorverbinding recht
Manchon
Kupplung

Article number	Bag / Box	Type
15PKW-1616	10 pc. / 150 pc.	16x16
15PKW-2020	10 pc. / 80 pc.	20x20
15PKW-2626	5 pc. / 50 pc.	26x26
15PKW-3232	5 pc. / 30 pc.	32x32



Type: 16PKW



Reducing coupling
Verloopstuk
Réduction
Kupplung-reduziert

Article number	Bag / Box	Type
16PKW-2016	10 pc. / 100 pc.	20x16
16PKW-2616	5 pc. / 60 pc.	26x16
16PKW-2620	5 pc. / 50 pc.	26x20
16PKW-3216	5 pc. / 50 pc.	32x16
16PKW-3220	5 pc. / 40 pc.	32x20
16PKW-3226	5 pc. / 40 pc.	32x26

Type: 17PKW (CW617)



Straight male adapter
Puntstuk
Raccord droit mâle
Übergangsfitting AG

Article number	Bag / Box	Type
17PKW-1604	10 pc. / 80 pc.	16x1/2"
17PKW-2004	10 pc. / 80 pc.	20x1/2"
17PKW-2005	10 pc. / 50 pc.	20x3/4"
17PKW-2605	10 pc. / 50 pc.	26x3/4"
17PKW-2606	10 pc. / 40 pc.	26x1"
17PKW-3206	10 pc. / 40 pc.	32x1"
17PKW-3207	5 pc. / 25 pc.	32x5/4"

Type: 17PKW-N (CW602)



Straight male adapter CW602
Puntstuk CW602
Raccord droit mâle CW602
Übergangsfitting AG CW602

Article number	Bag / Box	Type
17PKW-1604-N	10 pc. / 80 pc.	16x1/2"
17PKW-2004-N	10 pc. / 80 pc.	20x1/2"
17PKW-2005-N	10 pc. / 50 pc.	20x3/4"
17PKW-2605-N	10 pc. / 50 pc.	26x3/4"
17PKW-2606-N	10 pc. / 40 pc.	26x1"
17PKW-3206-N	10 pc. / 40 pc.	32x1"
17PKW-3207-N	5 pc. / 25 pc.	32x5/4"

1

2

3

4

5

6

7

8

9

10

11

12



Henco Synthetic Press

Henco Press WHITE - PKW

1 Type: 18PKW (CW617)

2



Straight female adapter
Schroefbus
Raccord droit femelle
Übergangsfitting IG

Article number	Bag / Box	Type
18PKW-1604	10 pc. / 80 pc.	16x1/2
18PKW-2004	10 pc. / 80 pc.	20x1/2
18PKW-2005	10 pc. / 50 pc.	20x3/4
18PKW-2605	10 pc. / 50 pc.	26x3/4
18PKW-2606	10 pc. / 40 pc.	26x1"
18PKW-3206	10 pc. / 40 pc.	32x1"
18PKW-3207	5 pc. / 25 pc.	32x5/4"

8 Type: 18PKW-X (INOX 316 L)

9



Straight female adapter INOX
Schroefbus INOX
Raccord droit femelle INOX
Übergangsfitting IG INOX

Article number	Bag / Box	Type
18PKW-1604-X	10 pc. / 80 pc.	16x1/2"
18PKW-2004-X	10 pc. / 80 pc.	20x1/2"
18PKW-2005-X	10 pc. / 50 pc.	20x3/4"
18PKW-2605-X	10 pc. / 50 pc.	26x3/4"
18PKW-2606-X	10 pc. / 40 pc.	26x1"
18PKW-3206-X	10 pc. / 40 pc.	32x1"
18PKW-3207-X	5 pc. / 25 pc.	32x1 1/4"

10

11

12

Type: 18PKW-N (CW602)



Straight female adapter CW602
Schroefbus CW602
Raccord droit femelle CW602
Übergangsfitting IG CW602

Article number	Bag / Box	Type
18PKW-1604-N	10 pc. / 80 pc.	16x1/2"
18PKW-2004-N	10 pc. / 80 pc.	20x1/2"
18PKW-2005-N	10 pc. / 50 pc.	20x3/4"
18PKW-2605-N	10 pc. / 50 pc.	26x3/4"
18PKW-2606-N	10 pc. / 40 pc.	26x1"
18PKW-3206-N	10 pc. / 40 pc.	32x1"
18PKW-3207-N	5 pc. / 25 pc.	32x5/4"



Type: 19PKW



Press fitting to eurocone
 Perskoppeling met euroconus aansluiting
 Raccord avec raccord à visser eurocone
 Pressfitting mit Eurokonus

Article number	Bag / Box	Type
19PKW-1605	10 pc. / 80 pc.	16x3/4" EK
19PKW-2005	10 pc. / 80 pc.	20x3/4" EK

Type: 26PKW



Press fitting with flat sealing
 Perskoppeling met vlakke dichting
 Raccord avec etachéité plate
 Pressfitting mit flach Versiegelung

Article number	Bag / Box	Type
26PKW-1605	10 pc. / 80 pc.	16x3/4"
26PKW-2005	10 pc. / 80 pc.	20x3/4"

Type: 27PKW



Elbow 45°
 Knie 45°
 Coude 45°
 Winkel 45°

Article number	Bag / Box	Type
27PKW-2626	5 pc. / 50 pc.	32x32
27PKW-3232	5 pc. / 30 pc.	32x32

Type: N-X (INOX 316 L)



INOX nipple
 INOX nippel
 Nipple INOX
 INOX-nippel

Article number	Bag	Type
N0404-X	10 pc.	1/2" x 1/2"
N0505-X	10 pc.	3/4" x 3/4"
N0606-X	10 pc.	1" x 1"

1

2

3

4

5

6

7

8

9

10

11

12



Henco Synthetic Press

Henco Press GAS - PKG

Gas: only allowed in countries where a HENCO GAS testing + certificate is available! (see www.henco.be)
 Gas: enkel toegelaten in landen waar er een HENCO GAS keur is + een certificaat voorhanden is! (zie www.henco.be)
 Gaz: seulement permis dans des pays où le contrôle a eu lieu + certificat est disponible! (Consultez www.henco.be)
 Gas: nur zugelassen in Länder wo HENCO GAS Prüfung geschehen ist + Zertifikat vorhanden ist! (Siehe www.henco.be)



Type: 1PKG



Elbow 90°
 Knie 90°
 Coude 90°
 Winkel 90°

Article number	Bag / Box	Type
1PKG-1616	10 pc. / 120 pc.	16x16
1PKG-2020	10 pc. / 80 pc.	20x20
1PKG-2626	5 pc. / 50 pc.	26x26
1PKG-3232	5 pc. / 30 pc.	32x32
1PKG-4040	5 pc. / 20 pc.	40x40

Type: 2PKG



Backplate elbow female
 Muurplaat binnendraad
 Culasse femelle
 Wandscheibe IG

Article number	Bag / Box	Type
2PKG-1603	10 pc. / 50 pc.	16x3/8"
2PKG-1604BP	10 pc. / 50 pc.	16x1/2"
2PKG-2004BP	10 pc. / 50 pc.	20x1/2"
2PKG-2005	5 pc. / 30 pc.	20x3/4"
2PKG-2605	5 pc. / 30 pc.	26x3/4"

Type: 2PKG-K



Backplate elbow female, short model
 Muurplaat binnendraad, laag
 Culasse femelle, modèle court
 Wandscheibe IG, kurzes Modell

Article number	Bag / Box	Type
2PKG-1604KBP	10 pc. / 50 pc.	16x1/2"

Type: 5PKG



Elbow 90° male adapter
 Knie 90° buitendraad
 Coude 90° mâle
 Winkel 90° AG

Article number	Bag / Box	Type
5PKG-1604	10 pc. / 60 pc.	16x1/2"
5PKG-2004	10 pc. / 60 pc.	20x1/2"
5PKG-2005	10 pc. / 50 pc.	20x3/4"
5PKG-2605	10 pc. / 40 pc.	26x3/4"
5PKG-3206	5 pc. / 20 pc.	32x1"
5PKG-4007	5 pc. / 15 pc.	40x5/4"



Did you know you could use the PK-tool wrench for PK and SK fittings to realise an even quicker installation of threaded Henco fittings.

> Find more information on **p. 156**

Type: 6PKG



Elbow 90° female adapter

Knie 90° binnendraad

Coude 90° femelle

Winkel 90° IG

Article number	Bag / Box	Type
6PKG-1604BP	10 pc. / 60 pc.	16x1/2"
6PKG-2004BP	10 pc. / 60 pc.	20x1/2"
6PKG-2005	10 pc. / 50 pc.	20x3/4"
6PKG-2605	10 pc. / 50 pc.	26x3/4"
6PKG-3206	5 pc. / 20 pc.	32x1"
6PKG-4007	5 pc. / 15 pc.	40x5/4"

Type: 9PKG



T-piece

T-stuk

Pièce en T

T-Stück

Article number	Bag / Box	Type
9PKG-161616	10 pc. / 60 pc.	16x16x16
9PKG-202020	10 pc. / 50 pc.	20x20x20
9PKG-262626	5 pc. / 30 pc.	26x26x26
9PKG-323232	5 pc. / 15 pc.	32x32x32
9PKG-404040	5 pc. / 10 pc.	40x40x40

Type: 10PKG



T-reduced centre

T-verlopend

Pièce en T réduit

T-reduziert

Article number	Bag / Box	Type
10PKG-201620	10 pc. / 50 pc.	20x16x20
10PKG-261626	5 pc. / 30 pc.	26x16x26
10PKG-262026	5 pc. / 30 pc.	26x20x26
10PKG-321632	5 pc. / 25 pc.	32x16x32
10PKG-322032	5 pc. / 25 pc.	32x20x32
10PKG-322632	5 pc. / 20 pc.	32x26x32
10PKG-401640*	5 pc. / 15 pc.	40x16x40
10PKG-402040	5 pc. / 15 pc.	40x20x40
10PKG-402640	5 pc. / 15 pc.	40x26x40
10PKG-403240	5 pc. / 10 pc.	40x32x40

*TILL EXHAUSTION OF STOCK



Henco Synthetic Press

Henco Press GAS - PKG

Type: 11PKG



T-branch and line reduced

T-2x verlopend

Pièce en T 2x réduit

T-2x reduziert

Article number	Bag / Box	Type
11PKG-201616	10 pc. / 50 pc.	20x16x16
11PKG-202016	10 pc. / 50 pc.	20x20x16
11PKG-261620	5 pc. / 30 pc.	26x16x20
11PKG-262016	5 pc. / 30 pc.	26x20x16
11PKG-262020	5 pc. / 30 pc.	26x20x20
11PKG-262616	5 pc. / 30 pc.	26x26x16
11PKG-262620	5 pc. / 30 pc.	26x26x20
11PKG-322026	5 pc. / 20 pc.	32x20x26
11PKG-322626	5 pc. / 20 pc.	32x26x26
11PKG-402032*	5 pc. / 15 pc.	40x20x32
11PKG-402632	5 pc. / 15 pc.	40x26x32
11PKG-403232	5 pc. / 10 pc.	40x32x32
11PKG-404026	5 pc. / 10 pc.	40x40x26
11PKG-404032*	5 pc. / 10 pc.	40x40x32

**TILL EXHAUSTION OF STOCK*

Type: 12PKG



T-enlarged branch

T-vergroot

Pièce en T agrandi

T-erweitert

Article number	Bag / Box	Type
12PKG-162016	10 pc. / 50 pc.	16x20x16
12PKG-202620	5 pc. / 30 pc.	20x26x20
12PKG-263226	5 pc. / 20 pc.	26x32x26
12PKG-324032	5 pc. / 10 pc.	32x40x32

Type: 13PKG



T-female centre

T-binnendraad

Pièce en T femelle

T-IG

Article number	Bag / Box	Type
13PKG-160416BP	10 pc. / 50 pc.	16x1/2"x16
13PKG-200420BP*	10 pc. / 50 pc.	20x1/2"x20
13PKG-200520	10 pc. / 30 pc.	20x3/4"x20
13PKG-260420BP*	5 pc. / 30 pc.	26x1/2"x20
13PKG-260426BP	5 pc. / 30 pc.	26x1/2"x26
13PKG-260526	5 pc. / 30 pc.	26x3/4"x26
13PKG-320532	5 pc. / 15 pc.	32x3/4"x32
13PKG-320632	5 pc. / 10 pc.	32x1"x32
13PKG-320732	5 pc. / 10 pc.	32x5/4"x32
13PKG-400640	5 pc. / 10 pc.	40x1"x40
13PKG-400740	5 pc. / 10 pc.	40x5/4"x40

** TILL EXHAUSTION OF STOCK*



Did you know you could use the PK-tool wrench for PK and SK fittings to realise an even quicker installation of threaded Henco fittings.

> Find more information on **p. 156**

Type: 14PKG



T-male centre
T-buitendraad
Pièce en T mâle
T-AG

Article number	Bag / Box	Type
14PKG-160416	10 pc. / 50 pc.	16x1/2"x16
14PKG-200420*	10 pc. / 40 pc.	20x1/2"x20
14PKG-260426	5 pc. / 20 pc.	26x1/2"x26
14PKG-260626	5 pc. / 20 pc.	26x1"x26

**TILL EXHAUSTION OF STOCK*

Type: 15PKG



Straight coupling
Perssok
Manchon
Kupplung

Article number	Bag / Box	Type
15PKG-1616	10 pc. / 150 pc.	16x16
15PKG-2020	10 pc. / 80 pc.	20x20
15PKG-2626	5 pc. / 50 pc.	26x26
15PKG-3232	5 pc. / 30 pc.	32x32
15PKG-4040	5 pc. / 25 pc.	40x40

Type: 16PKG



Reducing coupling
Verloopstuk
Réduction
Kupplung-reduziert

Article number	Bag / Box	Type
16PKG-2016	10 pc. / 100 pc.	20x16
16PKG-2616	5 pc. / 60 pc.	26x16
16PKG-2620	5 pc. / 50 pc.	26x20
16PKG-3216	5 pc. / 50 pc.	32x16
16PKG-3220	5 pc. / 40 pc.	32x20
16PKG-3226	5 pc. / 40 pc.	32x26
16PKG-4026	5 pc. / 30 pc.	40x26
16PKG-4032	5 pc. / 30 pc.	40x32



Henco Synthetic Press

Henco Press GAS - PKG

1 Type: 17PKG

2

Straight male adapter
Puntstuk
Raccord droit mâle
Übergangsfitting AG



Article number	Bag / Box	Type
17PKG-1604	10 pc. / 80 pc.	16x1/2"
17PKG-2004	10 pc. / 80 pc.	20x1/2"
17PKG-2005	10 pc. / 50 pc.	20x3/4"
17PKG-2605	10 pc. / 50 pc.	26x3/4"
17PKG-2606	10 pc. / 40 pc.	26x1"
17PKG-3206	10 pc. / 40 pc.	32x1"
17PKG-3207	5 pc. / 25 pc.	32x5/4"
17PKG-4006	5 pc. / 25 pc.	40x1"
17PKG-4007	5 pc. / 25 pc.	40x5/4"

3

4 Type: 18PKG

5

Straight female adapter
Schroefbus
Raccord droit femelle
Übergangsfitting IG



Article number	Bag / Box	Type
18PKG-1604	10 pc. / 80 pc.	16x1/2"
18PKG-2004	10 pc. / 80 pc.	20x1/2"
18PKG-2005	10 pc. / 50 pc.	20x3/4"
18PKG-2605	10 pc. / 50 pc.	26x3/4"
18PKG-2606	10 pc. / 40 pc.	26x1"
18PKG-3206	10 pc. / 40 pc.	32x1"
18PKG-3207	5 pc. / 25 pc.	32x5/4"
18PKG-4006	5 pc. / 25 pc.	40x1"
18PKG-4007	5 pc. / 25 pc.	40x5/4"

6

7

8

9

10

11

12

Type: 27PKG



Elbow 45°
Knie 45°
Coude 45°
Winkel 45°

Article number	Bag / Box	Type
27PKG-4040	5 pc. / 25 pc.	40x40



A = 75mm | B = 90 mm

Detailed overview of Super Sizes possibilities

- 1
- 2
- 3
- 4
- 5
- 6
- 7
- 8
- 9
- 10
- 11
- 12

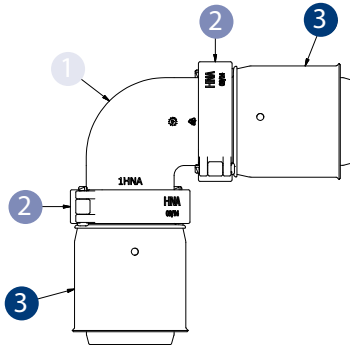

1PK

- ① 1HNA or 1HNB
- ② HNA or HNB
- ③ 8HNA-PK40 or 8HNA-PK50 or 8HNA-PK63 or 8HNA-PK75 or 8HNB-PK90

Example / Voorbeeld / Exemple / Beispiel

1PK-7575 = 1x 1HNA + 2xHNA + 2x 8HNA-PK75

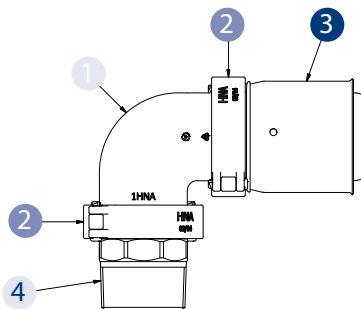

5PK / 6PK

- ① 1HNA or 1HNB
- ② HNA or HNB
- ③ 8HNA-PK75 or 8HNB-PK90
- ④ 17HNA-10 or 17HNA-12 or 18HNA-06 or 18HNA-10 or 18HNA-12 or 18HNB-14

Example / Voorbeeld / Exemple / Beispiel

5PK-7510 = 1x 1HNA + 2xHNA + 1x 8HNA-PK75 + 1x17HNA-10

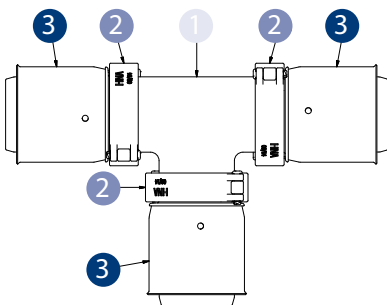

9PK / 10PK / 11PK / 12PK (75mm)

- ① 9HNA
- ② HNA
- ③ 8HNA-PK32 or 8HNA-PK40 or 8HNA-PK50 or 8HNA-PK63 or 8HNA-PK75

Example / Voorbeeld / Exemple / Beispiel

9PK-757575 = 1x 9HNA + 3xHNA + 3x 8HNA-PK75

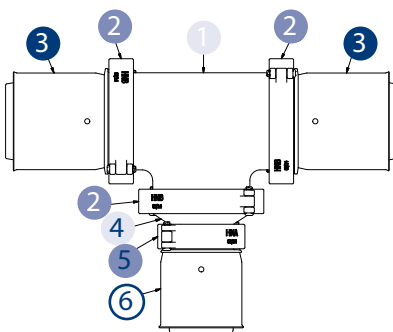

10PK / 11PK / 12PK (90mm)

- ① 9HNB
- ② HNB
- ③ 8HNB-PK90
- ④ 16HNBA
- ⑤ HNA
- ⑥ 8HNA-PK32 or 8HNA-PK40 or 8HNA-PK50 or 8HNA-PK63 or 8HNA-PK75

Example / Voorbeeld / Exemple / Beispiel

10PK-905090 = 1x 9HNB + 3x HNB + 2x 8HNB-PK90 + 1x 16HNBA + 1xHNA + 8HNA-PK50



Henco Synthetic Press

Henco Press SUPER SIZES

A = 75mm | B = 90 mm

- 1
- 2
- 3
- 4
- 5
- 6
- 7
- 8
- 9
- 10
- 11
- 12

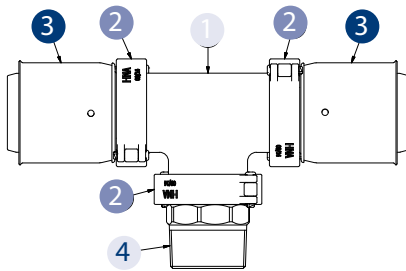

13PK / 14PK

- 1 9HNA or 9HNB
- 2 HNA or HNB
- 3 8HNA-PK75 or 8HNB-PK90
- 4 17HNA-10 or 17HNA-12 or 18HNA-06 or 18HNA-10 or 18HNA-12 or 18HNB-14

Example / Voorbeeld / Exemple / Beispiel

13PK-750675 = 1x 9HNA + 3x HNA + 8HNA-PK75 + 18HNA-06

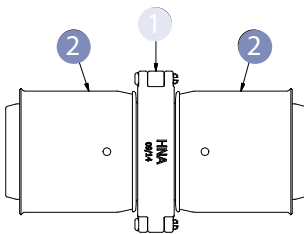

15PK / 16PK

- 1 HNA or HNB
- 2 8HNA-PK75 or 8HNB-PK90

Example / Voorbeeld / Exemple / Beispiel

15PK-7575 = 1x HNA + 2x 8HNA-PK75

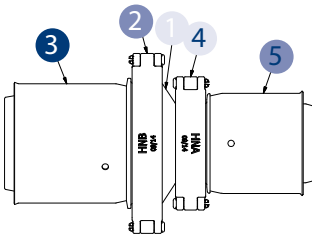

16PK

- 1 16HNBA
- 2 HNB
- 3 8HNB-PK90
- 4 HNA
- 5 8HNA-PK32 or 8HNA-PK40 or 8HNA-PK50 or 8HNA-PK63 or 8HNA-PK75

Example / Voorbeeld / Exemple / Beispiel

16PK-9063 = 1x 16HNBA + 1x HNB + 1x 8HNB-PK90 + 1x HNA + 1x 8HNA-PK63

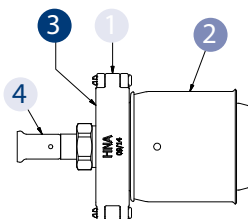

16PK-7516

- 1 HNA
- 2 8HNA-PK75
- 3 HNA-EK05
- 4 19P-1605 or 19P-1805 or 19P-2005 or 33P-1605 or 19SK-1605 or 19SK-2005



A = 75mm | B = 90 mm

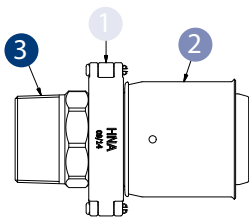

17PK / 18PK

- ① HNA or HNB
- ② 8HNA-PK75 or 8HNB-PK90
- ③ 17HNA or 18HNA or 18HNB

Example / Voorbeeld / Exemple / Beispiel

18PK-7512 = 1x HNA + 1x 8HNA-PK75 + 1x 18HNA-12

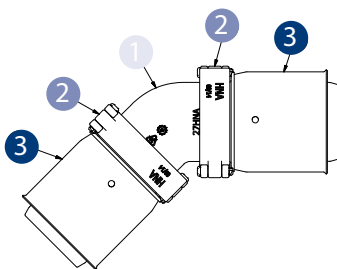

27PK

- ① 27HNA or 27HNB
- ② HNA or HNB
- ③ 8HNA-PK75 or 8HNB-PK90

Example / Voorbeeld / Exemple / Beispiel

27PK-9090 = 1x 27HNB + 2xHNB + 2x 8HNB-PK90

SUPER SIZE MONTAGE

*HN connection = "click and lock"
*PK connection = press connection

Possibilities

HNA: PK32 / PK40 / PK50 / PK63 / PK75
HNB: PK90

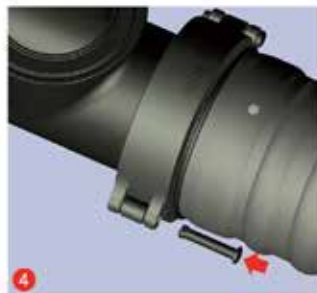
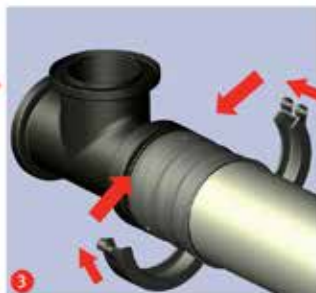
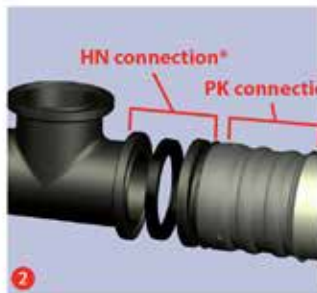



Henco Synthetic Press

Henco Press SUPER SIZES

A = 75mm | B = 90 mm

Type: 1HN



Elbow 90°
Knie 90°
Coude 90°
Winkel 90°

Article number	Bag / Box	Type
1HNA	1 pc. / 10 pc.	75x75
1HNB	1 pc.	90x90

Type: 9HN



T-piece
T-stuk
Pièce en T
T-Stück

Article number	Bag / Box	Type
9HNA	1 pc. / 7 pc.	75x75x75
9HNB	1 pc.	90x90x90

Type: 16HN



Reducing coupling
Verloopstuk
Pièce en T
Kupplung-reduziert

Article number	Bag / Box	Type
16HNBA	1 pc. / 15 pc.	90x75

Type: 27HN



Elbow 45°
Knie 45°
Coude 45°
Winkel 45°

Article number	Bag / Box	Type
27HNA	1 pc. / 15 pc.	75
27HNB	1 pc. / 4 pc.	90

Type: 8HN



Press fitting
Perskoppeling
Raccord à sertir
Pressfitting

Article number	Bag / Box	Type
8HNA-PK32	1 pc. / 20 pc.	75x32
8HNA-PK40	1 pc. / 20 pc.	75x40
8HNA-PK50	1 pc. / 12 pc.	75x50
8HNA-PK63	1 pc. / 12 pc.	75x63
8HNA-PK75	1 pc. / 12 pc.	75x75
8HNB-PK90	1 pc. / 4 pc.	90x90



A = 75mm | B = 90 mm

Type: HN



Bracket set
Beugelset
Support
Bügelset

Article number	Box	Type
HNA	1 pc.	75
HNB	1 pc.	90

Type: HN-PEN



Locking pin
Beugelpin
Goupille de verrouillage
Sicherungsstift

Article number	Bag / Box	Type
HN-PEN	50 pc. / 1000 pc.	75/90

Type: HN-U



Sealing ring
Dichtingsring
Anneau d'étanchéité
Dichtungsring

Article number	Bag	Type
HNA-U	10 pc.	75
HNB-U	10 pc.	90

Type: 17HN (CW617)



Brass adapter male
Messing adapter buitendraad
Raccord en laiton mâle
Anschluss Bügel AG

Article number	Bag / Box	Type
17HNA-10	1 pc. / 22 pc.	75x2"
17HNA-12	1 pc. / 18 pc.	75x2,5"

Type: 17HN-N (CW602)



Brass adapter male CW602
Messing adapter buitendraad CW602
Raccord en laiton mâle CW602
Anschluss Bügel AG CW602

Article number	Bag / Box	Type
17HNA-10-N	1 pc. / 22 pc.	75x2"
17HNA-12-N	1 pc. / 18 pc.	75x2,5"

Type: 17HN-X (INOX 316 L)



Stainless steel adapter male INOX
Inox adapter buitendraad INOX
Raccord en acier inoxydable mâle INOX
Anschluss Bügel aus Edelstahl (AG) INOX

Article number	Bag / Box	Type
17HNA-06-X	1 pc. / 30 pc.	75
17HNA-07-X	1 pc. / 30 pc.	75
17HNA-08-X	1 pc. / 30 pc.	75
17HNA-10-X	1 pc. / 20 pc.	75
17HNA-12-X	1 pc. / 20 pc.	75



Henco Synthetic Press

Henco Press SUPER SIZES

A = 75mm | B = 90 mm

Type: 18HN (CW617)



Brass adapter female
Messing adapter binnendraad
Raccord en laiton femelle
Anschluss Bügel IG

Article number	Bag / Box	Type
18HNA-06	1 pc. / 40 pc.	75x1"
18HNA-10	1 pc. / 27 pc.	75x2"
18HNA-12	1 pc. / 16 pc.	75x2,5"
18HNB-14	1 pc. / 12 pc.	90x3"

Type: 18HN-N (CW602)



Brass adapter female CW602
Messing adapter binnendraad CW602
Raccord en laiton femelle CW602
Anschluss Bügel IG CW602

Article number	Bag / Box	Type
18HNA-06-N	1 pc. / 40 pc.	75x1"
18HNA-10-N	1 pc. / 27 pc.	75x2"
18HNA-12-N	1 pc. / 16 pc.	75x2,5"
18HNB-14-N	1 pc. / 12 pc.	90x3"

Type: 18HN-X (INOX 316 L)



Stainless steel adapter female
Inox adapter binnendraad
Raccord en acier inoxydable femelle
Anschluss Bügel aus Edelstahl (IG)

Article number	Bag / Box	Type
18HNA-06-X	1 pc. / 30 pc.	75
18HNA-08-X	1 pc. / 30 pc.	75
18HNA-10-X	1 pc. / 20 pc.	75
18HNA-12-X	1 pc. / 20 pc.	75

Type: HN-STOP (CW617N)



Stop end for SUPER SIZES range
Eindstop voor SUPER SIZES gamma
Bouchon d'arrêt SUPER SIZES
Endkappe für das Sortiment SUPER SIZES

Article number	Bag / Box	Type
HNA-STOP*	1 pc. / 90 pc.	75
HNB-STOP	1 pc. / 40 pc.	90

*TILL EXHAUSTION OF STOCK

Type: HN-STOP-E (CW625N)



Stop end for SUPER SIZES range (CW625N)
Eindstop voor SUPER SIZES gamma (CW625N)
Bouchon d'arrêt SUPER SIZES (CW625N)
Endkappe für das Sortiment SUPER SIZES (CW625N)

Article number	Bag / Box	Type
HNA-STOP-E	1 pc. / 50 pc.	75



A = 75mm | B = 90 mm

Type: HNA-INLB (CW617N)



Base plate for Ecoline solution
Basisplaat voor Ecoline oplossing
Plaque de base pour la solution Ecoline
Grundplatte für Ecoline-Lösung

Article number	Bag / Box	Type
HNA-INLB	1 pc. / 30 pc.	16 x 3/4"

Type: HNA-INLB-E (CW625N)



Base plate for Ecoline solution CW625N
Basisplaat voor Ecoline oplossing CW625N
Plaque de base pour la solution Ecoline CW625N
Grundplatte für Ecoline-Lösung CW625N

Article number	Bag / Box	Type
HNA-INLB-E	1 pc. / 30 pc.	16 x 3/4"

Type: HNA-EK05 (CW617N)



Adapter HNA x EK 3/4"
Overgang HNA x EK 3/4"
Réduction HNA x EK 3/4"
Übergang HNA x EK 3/4"

Article number	Bag / Box	Type
HNA-EK05*	1 pc. / 50 pc.	75 x 3/4" EK

**TILL EXHAUSTION OF STOCK*

Type: HNA-EK05-E (CW625N)



Adapter HNA x EK 3/4" CW625N
Overgang HNA x EK 3/4" CW625N
Réduction HNA x EK 3/4" CW625N
Übergang HNA x EK 3/4" CW625N

Article number	Bag / Box	Type
HNA-EK05-E	1 pc. / 50 pc.	75 x 3/4" EK

Type: HN-COMP (INOX 316 L)



HN expansion bellow INOX
HN compensator INOX
HN compensateur INOX
HN Kompensator INOX

Article number	Bag	Type
HNA-COMP	1 pc.	75

Type: HN-FL (INOX 316 L)



Flange connection INOX
Flensaansluiting INOX
Raccordement bride INOX
Flanschverbindung INOX

Article number	Box	Type
HNAFL-DN50	1 pc.	HNAxDN50



Henco Synthetic Press

Henco Press SUPER SIZES

1

Type: HN-1

2



Elbow 90°

Knie 90°

Coude 90°

Winkel 90°

Article number	Box	Type
1PK-7575	1 pc.	75x75
1PK-9090	1 pc.	90x90

3

4

5

6

7

Type: HN-5 (CW617N)

8



Elbow 90° male adapter

Knie 90° buitendraad

Coude 90° mâle

Winkel 90° AG

Article number	Box	Type
5PK-7510	1 pc.	75x2"
5PK-7512	1 pc.	75x2 1/2"

9

10

11

12

Type: HN-6 (CW617N)



Elbow 90° female adapter

Knie 90° binnendraad

Coude 90° femelle

Winkel 90° IG

Article number	Box	Type
6PK-7506	1 pc.	75x1"
6PK-7510	1 pc.	75x2"
6PK-7512	1 pc.	75x2 1/2"
6PK-9014	1 pc.	90x3"

Type: HN-9



T-piece

T-stuk

Pièce en T

T-Stück

Article number	Box	Type
9PK-757575	1 pc.	75x75x75
9PK-909090	1 pc.	90x90x90



Type: HN-10



T-reduced centre

T-verlopend

Pièce en T réduit

T-reduziert

Article number	Box	Type
10PK-753275	1 pc.	75x32x75
10PK-754075	1 pc.	75x40x75
10PK-755075	1 pc.	75x50x75
10PK-756375	1 pc.	75x63x75
10PK-903290	1 pc.	90x32x90
10PK-904090	1 pc.	90x40x90
10PK-905090	1 pc.	90x50x90
10PK-906390	1 pc.	90x63x90
10PK-907590	1 pc.	90x75x90

Type: HN-11



T-branch and line reduced

T-2x verlopend

Pièce en T 2x réduit

T-2x reduziert

Article number	Box	Type
11PK-753232	1 pc.	75x32x32
11PK-753240	1 pc.	75x32x40
11PK-753250	1 pc.	75x32x50
11PK-753263	1 pc.	75x32x63
11PK-754040	1 pc.	75x40x40
11PK-754050	1 pc.	75x40x50
11PK-754063	1 pc.	75x40x63
11PK-755050	1 pc.	75x50x50
11PK-755063	1 pc.	75x50x63
11PK-756363	1 pc.	75x63x63
11PK-903232	1 pc.	90x32x32
11PK-903240	1 pc.	90x32x40
11PK-903250	1 pc.	90x32x50
11PK-903263	1 pc.	90x32x63
11PK-903275	1 pc.	90x32x75
11PK-904040	1 pc.	90x40x40
11PK-904050	1 pc.	90x40x50
11PK-904063	1 pc.	90x40x63
11PK-904075	1 pc.	90x40x75
11PK-905050	1 pc.	90x50x50
11PK-905063	1 pc.	90x50x63
11PK-905075	1 pc.	90x50x75
11PK-906363	1 pc.	90x63x63
11PK-906375	1 pc.	90x63x75
11PK-907575	1 pc.	90x75x75



Henco Synthetic Press

Henco Press SUPER SIZES

1 Type: HN-12

2



T-enlarged branch
T-vergroot
Pièce en T agrandi
T-erweitert

Article number	Box	Type
12PK-327532	1 pc.	32x75x32
12PK-329032	1 pc.	32X90X32
12PK-407540	1 pc.	40x75x40
12PK-409040	1 pc.	40x90x40
12PK-507550	1 pc.	50x75x50
12PK-509050	1 pc.	50x90x50
12PK-637563	1 pc.	63x75x63
12PK-639063	1 pc.	63x90x75
12PK-759075	1 pc.	75x90x75

9 Type: HN-13 (CW617N)

10



T-female centre
T-binnendraad
Pièce en T femelle
T-IG

Article number	Box	Type
13PK-750675	1 pc.	75x1"x75
13PK-751075	1 pc.	75x2"x75
13PK-751275	1 pc.	75x2 1/2"x75
13PK-901490	1 pc.	90x3"x90

Type: HN-14 (CW617N)



T-male centre
T-buitendraad
Pièce en T mâle
T-AG

Article number	Box	Type
14PK-751075	1 pc.	75x2"x75
14PK-751275	1 pc.	75x2 1/2"x75

Type: HN-15



Straight coupling
Perssok
Manchon
Kupplung

Article number	Box	Type
15PK-7575	1 pc.	75x75
15PK-9090	1 pc.	90x90



Type: HN-16



Reducing coupling
Verloopstuk
Réduction
Kupplung-reduziert

Article number	Box	Type
16PK-7532	1 pc.	75x32
16PK-7540	1 pc.	75x40
16PK-7550	1 pc.	75x50
16PK-7563	1 pc.	75x63
16PK-9032	1 pc.	90x32
16PK-9040	1 pc.	90x40
16PK-9050	1 pc.	90x50
16PK-9063	1 pc.	90x63
16PK-9075	1 pc.	90x75

Type: HN-17 (CW617N)



Straight male adapter
Puntstuk
Raccord droit mâle
Übergangsfitting AG

Article number	Box	Type
17PK-7510	1 pc.	75x2"
17PK-7512	1 pc.	75x2 1/2"

Type: HN-18 (CW617N)



Straight female adapter
Schroefbus
Raccord droit femelle
Übergangsfitting IG

Article number	Box	Type
18PK-7506	1 pc.	75x1"
18PK-7510	1 pc.	75x2"
18PK-7512	1 pc.	75x2 1/2"
18PK-9014	1 pc.	90x3"

Type: HN-27



Elbow 45°
Knie 45°
Coude 45°
Winkel 45°

Article number	Box	Type
27PK-7575	1 pc.	75x75
27PK-9090	1 pc.	90x90

1

2

3

4

5

6

7

8

9

10

11

12



Henco Synthetic Press

Henco Ecoline

Type: HNA-ECOLINE-SET



Basic set for Inliner
 Basisset voor Inliner
 Set de base pour Inliner
 Grundsatz für Inliner

Article number	Bag / Box	Type
HNA-ECOLINE-SET	1 pc. / -	

Composition:
 1x 9HNA (T-piece)
 4x HNA (Bracket set)
 1x HNA-EK05 (Adapter HNA-EK)
 1x HNA-INLB (Base plate for inliner)

The Henco ECO-line is an energy saving solution for recirculation loops, which limits heat loss between supply and return pipe.

A separate pipe for the circulation water is no longer required.

Designed on the Henco Super Size concept, it also combines modularity and easy installation.

ONE CONCEPT FOR ALL DIMENSIONS FROM 40 UP TO 75MM

- Cost effective
- Easy installation
- Less space consumption
- Anti legionellosis

Additional items to complete the ECOLINE installation *

Article number	Description	Page
8HNA-PK...	Press fitting 40, 50, 63 or 75	56
50-MXC1620	Henco 1L PE-Xc 16x2 - 50m	-
19P-1605	Nickel plated press-fit adapter to eurocone 16x3/4"	79
19P-2005	Nickel plated press-fit adapter to eurocone 20x3/4"	79
33P-1605	Nickel plated press-fit adapter to eurocone 90° 16x3/4"	83
19PK-1605	Press fit swivel to eurocone 16x3/4"	38
19PK-2005	Press fit swivel to eurocone 20x3/4"	38
19SK-1605	Push fitting with eurocone connection 16x3/4"	70
19SK-2005	Push fitting with eurocone connection 20x3/4"	70



* To complete the Ecoline installation you need to have a circulator and thermostatic balancing valve (not in Henco range)



	<i>Page</i>
<i>Henco Vision Fittings</i>	<i>66</i>
<i>Manifolds</i>	<i>72</i>



Henco Vision - Push Fit

Henco Vision Fittings



Did you know you could use our galvanised bracket plates for the 2S?

> Find more information on **p. 161**

Type: 1SK



Elbow 90°

Knie 90°

Coude 90°

Winkel 90°

Article number	Bag / Box	Type
1SK-1616	10 pc. / 70 pc.	16x16
1SK-2020	10 pc. / 50 pc.	20x20
1SK-2626	5 pc. / 40 pc.	26x26

Type: 2SK



Backplate elbow female

Sanitair muurplaat binnendraad

Culasse pour sanitaire femelle

Sanitär Wandscheibe IG

Article number	Bag / Box	Type
2SK-1604BP	10 pc. / 40 pc.	16x1/2"
2SK-2004BP	10 pc. / 40 pc.	20x1/2"
2SK-2005	10 pc. / 30 pc.	20x3/4"
2SK-2605	5 pc. / 20 pc.	26x3/4"

Type: 2S (CW617N)



Backplate elbow female, short model

Sanitair muurplaat binnendraad, laag

Culasse pour sanitaire femelle, modèle court

Sanitär Wandscheibe IG, kurzes Modell

Article number	Bag / Box	Type
2S-1604K	10 pc. / 50 pc.	16 x 1/2"

Type: 3SK (CW617N)



Double backplate elbow female, short model

Dubbel sanitair muurplaat binnendraad, laag

Culasse double pour sanitaire, modèle court

Sanitär Wandscheibe doppelt IG, kurzes Modell

Article number	Bag / Box	Type
3SK-160416BP	10 pc. / 30 pc.	16x1/2"x16
3SK-200420BP	10 pc. / 30 pc.	20x1/2"x20



Did you know you could use the PK-tool wrench for PK and SK fittings to realise an even quicker installation of threaded Henco fittings.

> Find more information on **p. 156**

Type: 5SK (CW617N)



Elbow 90° male adapter
Knie 90° buitendraad
Coude 90° mâle
Winkel 90° AG

Article number	Bag / Box	Type
5SK-1604	10 pc. / 60 pc.	16x1/2"
5SK-2004	10 pc. / 50 pc.	20x1/2"
5SK-2005	10 pc. / 40 pc.	20x3/4"
5SK-2605	5 pc. / 30 pc.	26x3/4"

Type: 6SK (CW617N)



Elbow 90° female adapter
Knie 90° binnendraad
Coude 90° femelle
Winkel 90° IG

Article number	Bag / Box	Type
6SK-1604BP	10 pc. / 60 pc.	16x1/2"
6SK-2004BP	10 pc. / 60 pc.	20x1/2"
6SK-2005	10 pc. / 30 pc.	20x3/4"
6SK-2605	10 pc. / 30 pc.	26x3/4"

Type: 9SK



T-piece
T-stuk
Pièce en T
T-Stück

Article number	Bag / Box	Type
9SK-161616	10 pc. / 40 pc.	16x16x16
9SK-202020	10 pc. / 30 pc.	20x20x20
9SK-262626	5 pc. / 20 pc.	26x26x26

Type: 10SK



T-reduced centre
T-verlopend
Pièce en T réduit
T-reduziert

Article number	Bag / Box	Type
10SK-201620	10 pc. / 40 pc.	20x16x20
10SK-261626	5 pc. / 25 pc.	26x16x26
10SK-262026	5 pc. / 20 pc.	26x20x26

- 1
- 2
- 3
- 4
- 5
- 6
- 7
- 8
- 9
- 10
- 11
- 12



Henco Vision - Push Fit

Henco Vision Fittings

Type: 11SK



T-branch and line reduced

T-2x verlopend

Pièce en T 2x réduit

T-2x reduziert

Article number	Bag / Box	Type
11SK-201616	10 pc. / 40 pc.	20x16x16
11SK-202016	10 pc. / 30 pc.	20x20x16
11SK-261620	5 pc. / 25 pc.	26x16x20
11SK-262016*	5 pc. / 25 pc.	26x20x16
11SK-262020	5 pc. / 25 pc.	26x20x20
11SK-262616	5 pc. / 25 pc.	26x26x16
11SK-262620	5 pc. / 20 pc.	26x26x20

**TILL EXHAUSTION OF STOCK*

Type: 12SK



T-enlarged branch

T-vergroot

Pièce en T agrandi

T-erweitert

Article number	Bag / Box	Type
12SK-162016	10 pc. / 40 pc.	16x20x16
12SK-202620	5 pc. / 30 pc.	20x26x20

Type: 13SK (CW617N)



T-female centre

T-binnendraad

Pièce en T femelle

T-IG

Article number	Bag / Box	Type
13SK-160416BP	10 pc. / 40 pc.	16x1/2"x16
13SK-200420BP	10 pc. / 30 pc.	20x1/2"x20
13SK-200520	10 pc. / 30 pc.	20x3/4"x20
13SK-260420BP	5 pc. / 20 pc.	26x1/2"x20
13SK-260426BP	5 pc. / 20 pc.	26x1/2"x26
13SK-260526	5 pc. / 20 pc.	26x3/4"x26

Type: 14SK (CW617N)



T-male centre

T-buitendraad

Pièce en T mâle

T-AG

Article number	Bag / Box	Type
14SK-160416	10 pc. / 40 pc.	16x1/2"x16
14SK-200420	10 pc. / 30 pc.	20x1/2"x20
14SK-260426	5 pc. / 20 pc.	26x1/2"x26



Type: 15SK



Straight coupling
Persok
Manchon
Kupplung

Article number	Bag / Box	Type
15SK-1616	10 pc. / 70 pc.	16x16
15SK-2020	10 pc. / 60 pc.	20x20
15SK-2626	5 pc. / 30 pc.	26x26

Type: 16SK



Reducing coupling
Verloopstuk
Réduction
Kupplung-reduziert

Article number	Bag / Box	Type
16SK-2016	10 pc. / 80 pc.	20x16
16SK-2616	10 pc. / 50 pc.	26x16
16SK-2620	10 pc. / 40 pc.	26x20

Type: 17SK (CW617N)



Straight male adapter
Puntstuk
Raccord droit mâle
Übergangsfitting AG

Article number	Bag / Box	Type
17SK-1603	10 pc. / 80 pc.	16x3/8"
17SK-1604	10 pc. / 80 pc.	16x1/2"
17SK-2004	10 pc. / 60 pc.	20x1/2"
17SK-2005	10 pc. / 60 pc.	20x3/4"
17SK-2605	10 pc. / 40 pc.	26x3/4"
17SK-2606	10 pc. / 40 pc.	26x1"

Type: 18SK (CW617N)



Straight female adapter
Schroefbus
Raccord droit femelle
Übergangsfitting IG

Article number	Bag / Box	Type
18SK-1604	10 pc. / 80 pc.	16x1/2"
18SK-2004	10 pc. / 80 pc.	20x1/2"
18SK-2005	10 pc. / 60 pc.	20x3/4"
18SK-2605	10 pc. / 50 pc.	26x3/4"
18SK-2606	10 pc. / 40 pc.	26x1"



Henco Vision - Push Fit

Henco Vision Fittings

1 Type: 17SKS (CW617N)

2

3



Straight nipple male
Puntstuk
Raccord droit mâle
Übergangsfitting AG

Article number	Bag / Box	Type
17SKS-2004	5 pc. / 150 pc.	20x1/2"
17SKS-2005	5 pc. / 150 pc.	20x3/4"
17SKS-2604	5 pc. / 100 pc.	26x1/2"
17SKS-2605	5 pc. / 100 pc.	26x3/4"

Applicable with HENCO Vision fittings & Full Flow Manifold

4

5

6

7

8 Type: 18SKS (CW617N)

9

10



Straight nipple female
Recht aansluitstuk binnendraad
Raccord droit femelle
Übergangsfitting IG

Article number	Bag / Box	Type
18SKS-2004	5 pc. / 150 pc.	20x1/2"
18SKS-2005	5 pc. / 100 pc.	20x3/4"
18SKS-2604	5 pc. / 100 pc.	26x1/2"
18SKS-2605	5 pc. / 80 pc.	26x3/4"

Applicable with HENCO Vision fittings & Full Flow Manifold

11

12

Type: 19SK



Push fitting with eurocone connection
Steekkoppeling met euroconus-aansluiting
Raccord push fit avec eurocone
Steckkupplung mit Eurokonus

Article number	Bag / Box	Type
19SK-1505*	10 pc. / 80 pc.	15x3/4" EK
19SK-1605	10 pc. / 80 pc.	16x3/4" EK
19SK-2005	10 pc. / 80 pc.	20x3/4" EK

**Not suited for embedding in floors and walls*

Type: 26SK



Push fitting with swivel and flat sealing
Steekkoppeling met wartel en vlakke dichting
Raccord push fit avec raccord ecrou étanchéité plate
Steckkupplung mit Drehbar und flach Versiegelung

Article number	Bag / Box	Type
26SK-1605	10 pc. / 80 pc.	16x3/4"
26SK-2005	10 pc. / 80 pc.	20x3/4"



Type: SK-PIESTOP



Stop end for pipe
Eindstop voor buis
Bouchon pour tube
Endkappe für Rohre

Article number	Bag / Box	Type
SK-PIESTOP16	10 pc. / 120 pc.	16
SK-PIESTOP20	10 pc. / 80 pc.	20
SK-PIESTOP26	10 pc. / 80 pc.	26

Type: SK-STOPCLIP



Reusable stop and clip for push fit connection
Herbruikbare stop en clip passend in een steekkoppeling
Bouchon et clip réutilisables pour connection push fit
Stopfen und clip für Steckanschluss, wieder verwendbar

Article number	Bag / Box	Type
SK-STOPCLIP16	10 pc. / 120 pc.	16
SK-STOPCLIP20	10 pc. / 100 pc.	20
SK-STOPCLIP26	10 pc. / 80 pc.	26

Type: VISION SET



Vision revision set
Vision revisie set
Set de révision Vision
Vision set

Article number	Bag / Box	Type
VISION SET 16	1 pc. / 100 pc.	16
VISION SET 20	1 pc. / 90 pc.	20
VISION SET 26	1 pc. / 80 pc.	26

Type: VISION KEY



Vision disassembly key
Vision demontage sleutel
Clé de démontage Vision
Vision Entriegelungsschlüssel

Article number	Bag / Box	Type
VISION-KEY16	1 pc. / 200 pc.	16
VISION-KEY20	1 pc. / 100 pc.	20
VISION-KEY26	1 pc. / 100 pc.	26



Henco Vision - Push Fit

Manifolds

1 Type: VSK-1616



Extension or body for manifold, two SK connections Ø16
Verlengstuk of basis voor verdeler, twee SK-aansluitingen Ø16
Complément ou base collecteur, deux sorties SK Ø16
Erweiterung oder Basiskörper für Verteiler, zwei SK-Anschlüssen Ø16

Article number	Bag / Box	Type
VSK-1616	1 pc. / 14 pc.	16-16

6 Type: VSK-161616



Extension or body for manifold, three SK connections Ø16
Verlengstuk of basis voor verdeler, drie SK-aansluitingen Ø16
Complément ou base collecteur, trois sorties SK Ø16
Erweiterung oder Basiskörper für Verteiler, drei SK-Anschlüssen Ø16

Article number	Bag / Box	Type
VSK-161616	1 pc. / 14 pc.	16-16-16

11 Type: SK-B05



Bracket for manifolds
Montagebeugel voor verdelers
Double support pour collecteurs
Halter für Verteiler

Article number	Bag / Box	Type
SK-B05	1 pc. / 100 pc.	B05

See chapter 6A for more options for the Full Flow Manifold



	<i>Page</i>
<i>Henco Brass Press Fittings</i>	<i>74</i>
<i>Henco Brass Press Fittings GAS</i>	<i>88</i>



Henco Brass Press

Henco Brass Press Fittings

Type: 1P



Elbow 90°
Knie 90°
Coude 90°
Winkel 90°

Article number	Bag / Box	Type
1P-1616	10 pc. / 150 pc.	16x16
1P-1818*	10 pc. / 100 pc.	18x18
1P-2020	10 pc. / 80 pc.	20x20
1P-2626	5 pc. / 50 pc.	26x26
1P-3232	5 pc. / 30 pc.	32x32

**TILL EXHAUSTION OF STOCK*

Type: 2P



Backplate elbow female
Sanitair muurplaat binnendraad
Culasse pour sanitaire femelle
Sanitär Wandscheibe IG

Article number	Bag / Box	Type
2P-1604	10 pc. / 50 pc.	16x1/2"
2P-1804	10 pc. / 50 pc.	18x1/2"
2P-2004	10 pc. / 50 pc.	20x1/2"
2P-2005	10 pc. / 50 pc.	20x3/4"
2P-2605	5 pc. / 40 pc.	26x3/4"

Type: 2P-K



Backplate elbow female, short model
Sanitair muurplaat binnendraad, laag
Culasse double pour sanitaire, modèle court
Sanitär Wandscheibe IG, kurzes Modell

Article number	Bag / Box	Type
2P-1404K	10 pc. / 50 pc.	14x1/2"
2P-1604K	10 pc. / 50 pc.	16x1/2"

Type: 3P



Double backplate elbow female
Sanitair muurplaat binnendraad dubbel
Culasse double pour sanitaire
Sanitär Wandscheibe doppelt IG

Article number	Bag / Box	Type
3P-160416	10 pc. / 40 pc.	16x1/2"x16
3P-200420	10 pc. / 40 pc.	20x1/2" x20

Type: 3P-VK



Double backplate elbow female (flow), short model
Doorstroom muurplaat binnendraad, laag
Culasse double femelle (écoulement), modèle court
Wandscheibe doppelt IG (Fluss), kurzes Modell

Article number	Bag / Box	Type
3P-160416VK	5 pc. / 20 pc.	16x1/2"x16 (40 mm)
3P-200420VK	5 pc. / 20 pc.	20x1/2"x20 (40 mm)
3P-260426VK	5 pc. / 20 pc.	26x1/2"x26 (40 mm)

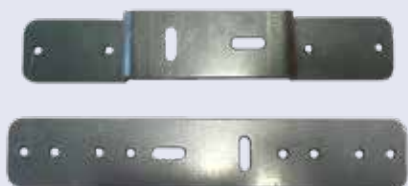

Did you know you could use our galvanised bracket plates for the 2P, 2P-K, 3P-VK and 4P?

> Find more information on **p. 161**

Type: 4P



Backplate elbow female, extended model
Sanitair muurplaat binnendraad, hoog
Culasse pour sanitaire femelle, modèle long
Sanitär Wandscheibe IG, langes Modell

Article number	Bag / Box	Type
4P-1604	10 pc. / 40 pc.	16x1/2"

Type: 5P



Elbow 90° male adapter
Knie 90° buitendraad
Coude 90° mâle
Winkel 90° AG

Article number	Bag / Box	Type
5P-1603	10 pc. / 150 pc.	16x3/8"
5P-1604	10 pc. / 150 pc.	16x1/2"
5P-1804	10 pc. / 120 pc.	18x1/2"
5P-2004	10 pc. / 100 pc.	20x1/2"
5P-2005	10 pc. / 80 pc.	20x3/4"
5P-2605	10 pc. / 60 pc.	26x3/4"
5P-2606	5 pc. / 40 pc.	26x1"
5P-3206	5 pc. / 25 pc.	32x1"

Type: 5P-DZR (CW602N)



Elbow 90° male adapter
Knie 90° buitendraad
Coude 90° mâle
Winkel 90° AG

Article number	Bag / Box	Type
5P-1603DZR	10 pc. / 150 pc.	16x3/8"
5P-1604DZR	10 pc. / 150 pc.	16x1/2"

Type: 6P



Elbow 90° female adapter
Knie 90° binnendraad
Coude 90° femelle
Winkel 90° IG

Article number	Bag / Box	Type
6P-1604	10 pc. / 120 pc.	16x1/2"
6P-1804	10 pc. / 120 pc.	18x1/2"
6P-2004	10 pc. / 120 pc.	20x1/2"
6P-2005	10 pc. / 50 pc.	20x3/4"
6P-2605	5 pc. / 50 pc.	26x3/4"

- 1
- 2
- 3
- 4
- 5
- 6
- 7
- 8
- 9
- 10
- 11
- 12



Henco Brass Press

Henco Brass Press Fittings

Type: 7P



Backplate elbow male
Sanitair muurplaat buitendraad met binnendraad 1/2"
Culasse pour sanitaire male
Sanitär Wandscheibe AG

Article number	Bag / Box	Type
7P-1605	5 pc. / 30 pc.	16x3/4" (78 mm)
7P-1605K	5 pc. / 30 pc.	16x3/4" (60 mm)
7P-1605L	5 pc. / 30 pc.	16x3/4" (70 mm)

Type: 8P



Sanitary adapter female
Sanitair aansluitstuk met binnendraad
Culasse pour sanitaire femelle
UP-Spülkastenwinkel

Article number	Bag / Box	Type
8P-1604	10 pc. / 50 pc.	16x1/2"

Type: 9P



T-piece
T-stuk
Pièce en T
T-Stück

Article number	Bag / Box	Type
9P-161616	10 pc. / 60 pc.	16x16x16
9P-181818	10 pc. / 60 pc.	18x18x18
9P-202020	10 pc. / 50 pc.	20x20x20
9P-262626	5 pc. / 30 pc.	26x26x26

Type: 10P



T-reduced centre
T-verlopend
Pièce en T-réduit
T-reduziert

Article number	Bag / Box	Type
10P-201620	10 pc. / 50 pc.	20x16x20
10P-261626	5 pc. / 30 pc.	26x16x26
10P-262026	5 pc. / 30 pc.	26x20x26
10P-321632	5 pc. / 20 pc.	32x16x32
10P-322032	5 pc. / 20 pc.	32x20x32

Type: 11P



T-branch and line reduced
T-2x verlopend
Pièce en T 2x réduit
T-2x reduziert

Article number	Bag / Box	Type
11P-201616	10 pc. / 50 pc.	20x16x16
11P-202016	10 pc. / 50 pc.	20x20x16
11P-261620	5 pc. / 30 pc.	26x16x20
11P-262020	5 pc. / 30 pc.	26x20x20
11P-262616	5 pc. / 30 pc.	26x26x16
11P-262620	5 pc. / 30 pc.	26x26x20
11P-322026*	5 pc. / 20 pc.	32x20x26
11P-322626*	5 pc. / 20 pc.	32x26x26

*TILL EXHAUSTION OF STOCK



Type: 12P



T-enlarged branch
T-vergroot
Pièce en T agrandi
T-erweitert

Article number	Bag / Box	Type
12P-162016	10 pc. / 60 pc.	16x20x16
12P-202620	5 pc. / 30 pc.	20x26x20

Type: 13P



T-female centre
T-binnendraad
Pièce en T femelle
T-IG

Article number	Bag / Box	Type
13P-160416	10 pc. / 60 pc.	16x1/2"x16
13P-200420	10 pc. / 50 pc.	20x1/2"x20
13P-200520	10 pc. / 30 pc.	20x3/4"x20
13P-260426	5 pc. / 30 pc.	26x1/2"x26
13P-260526	5 pc. / 30 pc.	26x3/4"x26
13P-320532*	5 pc. / 20 pc.	32x3/4"x32

*TILL EXHAUSTION OF STOCK

Type: 14P



T-male centre
T-buitendraad
Pièce en T mâle
T-AG

Article number	Bag / Box	Type
14P-160416	10 pc. / 60 pc.	16x1/2"x16
14P-200420	10 pc. / 60 pc.	20x1/2"x20
14P-200520	5 pc. / 30 pc.	20x3/4"x20
14P-260426	5 pc. / 30 pc.	26x1/2"x26

Type: 15P



Straight coupling
Perssok
Manchon
Kupplung

Article number	Bag / Box	Type
15P-1616	10 pc. / 200 pc.	16x16
15P-1818	10 pc. / 150 pc.	18x18
15P-2020	10 pc. / 140 pc.	20x20
15P-2626	5 pc. / 80 pc.	26x26
15P-3232	5 pc. / 50 pc.	32x32



Henco Brass Press

Henco Brass Press Fittings

Type: 16P



Reducing coupling
Verloopstuk
Réduction
Kupplung-reduziert

Article number	Bag / Box	Type
16P-1816*	10 pc. / 150 pc.	18x16
16P-2016	10 pc. / 150 pc.	20x16
16P-2018*	10 pc. / 150 pc.	20x18
16P-2616	5 pc. / 100 pc.	26x16
16P-2620	5 pc. / 80 pc.	26x20
16P-3216*	5 pc. / 60 pc.	32x16
16P-3220*	5 pc. / 60 pc.	32x20
16P-3226	5 pc. / 60 pc.	32x26

**TILL EXHAUSTION OF STOCK*

Type: 17P



Straight male adapter
Puntstuk
Raccord droit mâle
Übergangsfitting AG

Article number	Bag / Box	Type
17P-1603	10 pc. / 150 pc.	16x3/8"
17P-1604	10 pc. / 150 pc.	16x1/2"
17P-1605	10 pc. / 150 pc.	16x3/4"
17P-1804	10 pc. / 150 pc.	18x1/2"
17P-1805	10 pc. / 150 pc.	18x3/4"
17P-2004	10 pc. / 150 pc.	20x1/2"
17P-2005	10 pc. / 150 pc.	20x3/4"
17P-2605	5 pc. / 80 pc.	26x3/4"
17P-2606	5 pc. / 80 pc.	26x1"
17P-3206	5 pc. / 50 pc.	32x1"
17P-3207	5 pc. / 40 pc.	32x5/4"

Type: 17P-DZR (CW602N)



Straight male adapter CW602N
Puntstuk CW602N
Raccord droit mâle CW602N
Übergangsfitting AG CW602N

Article number	Bag / Box	Type
17P-1603DZR	10 pc. / 150 pc.	16x3/8"
17P-1604DZR	10 pc. / 150 pc.	16x1/2"

Type: 17P-CS (CW724N)



Straight male adapter CW724N
Puntstuk CW724N
Raccord droit mâle CW724N
Übergangsfitting AG CW724N

Article number	Bag / Box	Type
17P-1604-CS	10 pc. / 170 pc.	16x1/2"
17P-2004-CS	10 pc. / 150 pc.	20x1/2"
17P-2005-CS	10 pc. / 140 pc.	20x3/4"
17P-2605-CS	10 pc. / 100 pc.	26x3/4"
17P-2606-CS	10 pc. / 80 pc.	26x1"



Type: 18P



Straight female adapter
Schroefbus
Raccord droit femelle
Übergangsfitting IG

Article number	Bag / Box	Type
18P-1604	10 pc. / 150 pc.	16x1/2"
18P-1804	10 pc. / 120 pc.	18x1/2"
18P-2004	10 pc. / 100 pc.	20x1/2"
18P-2005	10 pc. / 100 pc.	20x3/4"
18P-2605	5 pc. / 80 pc.	26x3/4"
18P-2606	5 pc. / 70 pc.	26x1"
18P-3206	5 pc. / 50 pc.	32x1"
18P-3207	5 pc. / 30 pc.	32x5/4"

Type: 19P



Press fit adapter to eurocone
Aansluiting met wartel en euroconus koppeling
Raccordement avec raccord à visser eurocone
Anschlussverschraubung mit Eurokonus

Article number	Bag / Box	Type
19P-1405	10 pc. / 150 pc.	14x3/4"
19P-1605	10 pc. / 150 pc.	16x3/4"
19P-1805	10 pc. / 150 pc.	18x3/4"
19P-2005	10 pc. / 140 pc.	20x3/4"

Type: 24P



Radiator connection nickel-plated 300 mm copper pipe Ø15
Radiatoraansluitbocht vernikkeld met 300 mm koperbuis Ø15
Alimentation radiateur nickelé 300 mm tube de cuivre Ø15
Heizkörperanschluss vernickelt 300 mm Kupferrohr Ø15

Article number	Bag / Box	Type
24P-1604	2 pc. / 50 pc.	16x15
24P-2004*	2 pc. / 50 pc.	20x15

**TILL EXHAUSTION OF STOCK*

Type: 25P



Radiator connection nickel-plated 1100 mm copper pipe Ø15
Radiatoraansluitbocht vernikkeld met 1100 mm koperbuis Ø15
Alimentation radiateur nickelé 1100 mm tube de cuivre Ø15
Heizkörperanschluss vernickelt 1100 mm Kupferrohr Ø15

Article number	Bag	Type
25P-1604*	2 pc.	16x15

**TILL EXHAUSTION OF STOCK*



Henco Brass Press

Henco Brass Press Fittings

Type: 26P



Press fitting self-filling
Aansluiting met buitendraad, vlakke dichting
Raccord auto-étanche
Pressfitting mit AG flachdichtend

Article number	Bag / Box	Type
26P-1604	10 pc. / 100 pc.	16x1/2"
26P-1605	10 pc. / 80 pc.	32x5/4"
26P-2004	10 pc. / 80 pc.	20x1/2"
26P-2005	10 pc. / 70 pc.	20x3/4"
26P-2605	5 pc. / 50 pc.	26x3/4"
26P-2606	5 pc. / 40 pc.	26x1"
26P-3206*	5 pc. / 25 pc.	32x1"

**TILL EXHAUSTION OF STOCK*

Type: 26P-Z



Press fitting swivel adapter
Aansluiting met wartel, vlakke dichting
Raccord à visser, joint plat
Pressfitting mit IG flachdichtend ohne Nippel

Article number	Bag / Box	Type
26P-16Z03	10 pc. / 150 pc.	16x3/8"
26P-16Z04	10 pc. / 150 pc.	16x1/2"
26P-16Z05	10 pc. / 80 pc.	16x3/4"
26P-20Z04	10 pc. / 150 pc.	20x1/2"
26P-20Z05	10 pc. / 70 pc.	20x3/4"
26P-26Z05	5 pc. / 50 pc.	26x3/4"
26P-26Z06	5 pc. / 40 pc.	26x1"
26P-32Z06	5 pc. / 40 pc.	32x1"
26P-32Z07	5 pc. / 40 pc.	32x5/4"

Type: 26P-Z-DZR (CW602N)



Press fitting swivel adapter CW602N
Aansluiting met wartel, vlakke dichting CW602N
Raccord à visser, joint plat CW602N
Pressfitting mit IG flachdichtend ohne Nippel CW602N

Article number	Bag / Box	Type
26P-16Z04DZR	10 pc. / 150 pc.	16x1/2"
26P-20Z04DZR	10 pc. / 150 pc.	20x1/2"
26P-20Z05DZR	10 pc. / 70 pc.	20x3/4"
26P-26Z05DZR	5 pc. / 50 pc.	26x3/4"

Type: N



Nipple for article 26P-Z
Nippel voor artikel 26P-Z
Nipple pour article 26P-Z
Nippel für Artikel 26P-Z

Article number	Bag / Box	Type
N04	10 pc. / 250 pc.	3/4"x3/4"
N05	10 pc. / 200 pc.	3/4 x 3/4
N06	25 pc. / 250 pc.	1"x1"



Type: 27P



Elbow 45°
Knie 45°
Coude 45°
Winkel 45°

Article number	Bag / Box	Type
27P-2626	5 pc. / 50 pc.	26x26
27P-3232	5 pc. / 30 pc.	32x32

Type: 28P



Double backplate elbow female, build up
Dubbele muurplaat binnendraad, opbouw
Culasse double pour sanitaire femelle
Sanitär Wandscheibe doppelt IG, Oberbau

Article number	Bag / Box	Type
28P-14041604-1	1 pc. / 20 pc.	14x1/2" - 16x1/2"
28P-16041604-1	1 pc. / 20 pc.	16x1/2" - 16x1/2"

Type: 28PV



Double backplate elbow female, build-in
Dubbele muurplaat binnendraad, inbouw
Culasse double surélevé
Wandwinkel doppelt erhöht

Article number	Bag / Box	Type
28PV-16031603-1	1 pc. / 15 pc.	16x3/8" - 16x3/8"
28PV-16041604-1	1 pc. / 15 pc.	16x1/2" - 16x1/2"

Type: 28PF



Double backplate elbow female for plaster
Dubbel muurplaat binnendraad voor gips
Culasse double femelle pour plâtre
Wandscheibe doppelt IG für Gips

Article number	Bag / Box	Type
28PF-16041604	1 pc. / 15 pc.	16x1/2" - 16x1/2"
28PF-20042004	1 pc. / 15 pc.	20x1/2" - 20x1/2"

- 1
- 2
- 3
- 4
- 5
- 6
- 7
- 8
- 9
- 10
- 11
- 12



Henco Brass Press

Henco Brass Press Fittings

Type: 29P-CS (CW724 R)



Press-fit adapter with copper pipe (CW724)
 Persfitting verlengd met koperbuis (CW724)
 Manchon à sertir avec tube en cuivre (CW724)
 Pressfitting mit Kupferrohr (CW724)

Article number	Bag / Box	Type
29P-1612-CS	10 pc. / 120 pc.	16x12
29P-1615-CS	10 pc. / 120 pc.	16x15
29P-2018-CS	10 pc. / 70 pc.	20x18
29P-2022-CS	10 pc. / 70 pc.	20x22
29P-2622-CS	10 pc. / 70 pc.	26x22

Type: 30P



Press-fit adapter to copper compression
 Overgangsstuk Henco pers x koperbuis knelkoppeling
 Manchon à sertir x tube en cuivre manchon à visser
 Pressfitting x Klemmverbinder für Kupferrohr

Article number	Bag / Box	Type
30P-1614S*	10 pc. / 120 pc.	16x14
30P-1615S-2	2 pc. / 100 pc.	16x15
30P-2022S	10 pc. / 100 pc.	20x22
30P-2622S	10 pc. / 80 pc.	26x22

**TILL EXHAUSTION OF STOCK*

Type: 31P



Double crossover tee
 Kruisingsvrij T-stuk
 Double T croisé
 Kreuzungs-T-Stück

Article number	Bag / Box	Type
31P-161616	1 pc. / 20 pc.	16x16x16
31P-201616	1 pc. / 20 pc.	20x16x16
31P-201620	1 pc. / 20 pc.	20x16x20
31P-202020	1 pc. / 20 pc.	20x20x20

Type: ISO-BOX



Insulation box for double crossover tee
 Isolatatiebox voor kruisingsvrij T-Stuk
 Boîte d'isolation pour T croisé
 Isolierboxen für Kreuzungs-T-Stück

Article number	Bag / Box	Type
ISO-BOX	1 pc. / 320 pc.	124x124x55mm



Type: 33P



Nickel plated press-fit adapter to eurocone, 90°
 Aansluiting met wartel en euroconus-koppeling vernikkeld, 90°
 Raccord à visser eurocone nickelé, 90°
 Anschlussverschraubung mit Eurokonus vernickelt, 90°

Article number	Bag / Box	Type
33P-1605	10 pc. / 60 pc.	16x3/4"

Type: 34P



Henco press swivel adapter with flat sealing, 90°
 Aansluiting met wartel vlakdichtend, 90°
 Raccord à visser joint plat, 90°
 Anschlussverschraubung mit AG flachdichtend, 90°

Article number	Bag / Box	Type
34P-1604	10 pc. / 120 pc.	16x1/2"
34P-3206	5 pc. / 40 pc.	32x1"

Type: 34P-CS (CW724 R)



Henco press swivel adapter with flat sealing, 90° (CW724 R)
 Aansluiting met wartel vlakdichtend, 90° (CW724 R)
 Raccord à visser joint plat, 90° (CW724 R)
 Anschlussverschraubung mit AG flachdichtend, 90° (CW724 R)

Article number	Bag / Box	Type
34P-1605-CS	10 pc. / 120 pc.	16x3/4"
34P-2004-CS	10 pc. / 80 pc.	20x1/2"
34P-2005-CS	10 pc. / 80 pc.	20x3/4"
34P-2605-CS	10 pc. / 70 pc.	26x3/4"

Type: 35P



Press-fit adapter to copper press (M-profile)
 Overgangstuk Henco pers naar koper pers (M-profiel)
 Manchon à sertir vers cuivre à sertir (profil M)
 Pressfitting Henco zu Pressfitting für Kupferrohr (M-profile)

Article number	Bag / Box	Type
35P-1615P*	10 pc. / 150 pc.	16x15
35P-2022P*	10 pc. / 80 pc.	20x22

* TILL EXHAUSTION OF STOCK



Henco Brass Press

Henco Brass Press Fittings

Type: 36P (CW724 R)



Press-fit adapter to copper press (V, M & SA profile)
 Overgangsstuk Henco pers naar koper pers (V, M & SA profiel)
 Manchon à sertir Henco vers cuivre à sertir (profil M, V & SA)
 Pressfitting Henco zu Pressfitting für Kupferrohr (Presskontur M, V & SA)

Article number	Bag / Box	Type
36P-1612P	10 pc. / 160 pc.	16x12Cu
36P-1614P	10 pc. / 150 pc.	16x14Cu
36P-1615P	10 pc. / 150 pc.	16x15Cu
36P-1616P	10 pc. / 150 pc.	16x16Cu
36P-2015P	10 pc. / 120 pc.	20x15Cu
36P-2018P	10 pc. / 120 pc.	20x18Cu
36P-2022P	10 pc. / 80 pc.	20x22Cu
36P-2622P	10 pc. / 70 pc.	26x22Cu
36P-2628P	10 pc. / 70 pc.	26x28Cu
36P-3228P	5 pc. / 50 pc.	32x28Cu

Type: 37P



Press-fit adapter to copper pipe, elbow
 Persfitting verlengd met koperbuis, knie
 Coude à sertir avec tube en cuivre soudé
 Pressfitting mit geschweisstem Kupferrohr, Winkel

Article number	Bag / Box	Type
37P-1412L	10 pc. / 60 pc.	14x12 (227/200mm)
37P-1612L	10 pc. / 40 pc.	16x12 (227/200mm)
37P-1615L	10 pc. / 40 pc.	16x15 (227/200mm)

Type: 39P



Double bend for radiator nickel-plated 300 mm copper pipe Ø15, connected end
 Dubbele radiatorbocht koperbuis Ø15, 300 mm, vernikkeld, doorverbonden einde
 Double courbe radiateur nickelé 300 mm tube en cuivre Ø15, bout rattaché
 Doppelter Heizkörperwinkel vernickelt 300 mm Kupferrohr Ø15, durchgestelltes Ende

Article number	Bag / Box	Type
39P-160450	1 pc. / 8 pc.	16x1/2" (AS = 50 mm)

Interaxis 50 mm

Type: 40P



Press-fit elbow to copper compression
 Knie Henco pers x koperbuis knelkoppeling
 Coude à sertir x tube en cuivre manchon à visser, 90°
 Winkel Henco Press x Klemmverbinder für Kupferrohr

Article number	Bag / Box	Type
40P-1615S	10 pc. / 60 pc.	16x15 Cu
40P-2022S	10 pc. / 60 pc.	20x22 Cu
40P-2622S	10 pc. / 60 pc.	26x22 Cu



Type: 41P



Brass press coupling for valve F-connection
 Messing perskoppeling voor F-aansluiting
 Connecteur F en laiton
 Pressfittung für F-Connection

Article number	Bag / Box	Type
41P-16	10 pc. / 40 pc.	16
41P-20	10 pc. / 40 pc.	20
41P-26	10 pc. / 40 pc.	26

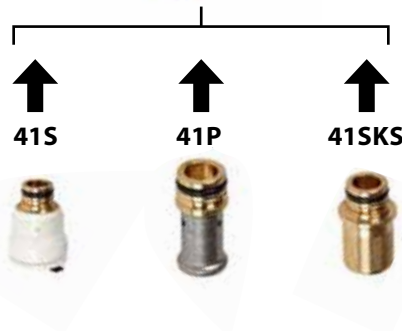

Type: 42P



Straight coupling PEX
 Doorverbinder recht PEX
 Manchon PEX
 Kupplung PEX

Article number	Bag / Box	Type
42P-161615	10 pc. / 200 pc.	16x2 - 16x1,5
42P-202019	10 pc. / 140 pc.	20x2 - 20x1,9

Type: 43P



T-piece Henco press 16mm x compression 15mm x press 16mm
 T-stuk Henco pers 16mm x koper knel 15mm x Henco pers 16mm
 Piece en T Henco sertir 16mm x machon à visser 15mm x Henco sertir 16mm
 T-stuck Henco press 16mm x Klemmverbinder 15mm x press 16mm

Article number	Bag / Box	Type
43P-161516	2 pc. / 50 pc.	16x15x16

- 1
- 2
- 3
- 4
- 5
- 6
- 7
- 8
- 9
- 10
- 11
- 12



Henco Brass Press

Henco Brass Press Fittings

1 Type: 44P



Bend 90° female connection toilet reservoir
Aansluitbocht inbouwreservoir toilet
Coude 90° femelle connexion réservoir toilet
Winkel 90° IG Anschluss Reservoir-Toilette

Article number	Bag / Box	Type
44P-1604	10 pc. / 60 pc.	16x1/2"

2

3

4

5

6 Type: 45P



Straight connection female toilet reservoir
Rechte aansluiting binnendraad toiletreservoir
Raccord droit femelle réservoir toilet
Anschluss IG Reservoir-Toilette

Article number	Bag / Box	Type
45P-1604	10 pc. / 150 pc.	16x1/2"

7

8

9

10

11 Type: 52P



Easy mounting/repair fitting
Eenvoudige montage/reparatie fitting
Raccord montage/réparation facile
Einfache Montage/Reparatur Fitting

Article number	Bag / Box	Type
52P16	1 pc. / 40 pc.	16x16
52P20	1 pc. / 30 pc.	20x20
52P26	1 pc. / 30 pc.	26x26
52P32	1 pc. / 20 pc.	32x32

for ø40, 50 and 63: chapter 2, type 53PK



Type: WALL BOX



Wall Box - press
 Wall Box - pers
 Wall Box - sertir
 Wall Box - Press

Article number	Box / Big Box	Type
WBP-1604-BL	10 pc. / 300 pc.	16x1/2" blue
WBP-1604-RO	10 pc. / 300 pc.	16x1/2" red
WBP-2004-BL	10 pc. / 300 pc.	20x1/2" blue
WBP-2004-RO	10 pc. / 300 pc.	20x1/2" red

Without mounting bracket 'WB-PLATE'



Instruction video

Type: WB-PLATE

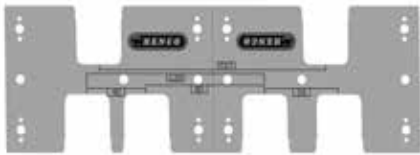

Wall Box mounting bracket
 Wall Box montage plaat
 Wall Box plaque de montage
 Wall Box Montage Bügel

Article number	Box / Outer Box	Type
WBPL-X	10 pc. / 60 pc.	GALV. STEEL

Type: P-PIESTOP



Stop end press for pipe
 Eindstop voor buis Pers
 Bouchon à sertir pour tube
 Endkappe Press für Rohre

Article number	Bag / Box	Type
P-PIESTOP16	10 pc. / 250 pc.	16x2
P-PIESTOP20	10 pc. / 200 pc.	20x2
P-PIESTOP26	10 pc. / 120 pc.	26x3
P-PIESTOP32	10 pc. / 70 pc.	32x3



Henco Brass Press

Henco Brass Press Fittings GAS

Gas: only allowed in countries where a HENCO GAS testing + certificate is available! (see www.henco.be)
Gas: enkel toegelaten in landen waar er een HENCO GAS keur is + een certificaat voorhanden is! (zie www.henco.be)
Gaz: seulement permis dans des pays où le contrôle a eu lieu + certificat est disponible! (Consultez www.henco.be)
Gas: nur zugelassen in Länder wo HENCO GAS Prüfung geschehen ist + Zertifikat vorhanden ist! (Siehe www.henco.be)

Henco brass press fittings for gas in combination with standard pipes gas, see page 23



Type: 1PG



Elbow 90°
Knie 90°
Coude 90°
Winkel 90°

Article number	Bag / Box	Type
1PG-1616	10 pc. / 150 pc.	16x16
1PG-2020	10 pc. / 80 pc.	20x20
1PG-2626	5 pc. / 50 pc.	26x26
1PG-3232	5 pc. / 30 pc.	32x32

Type: 2PG

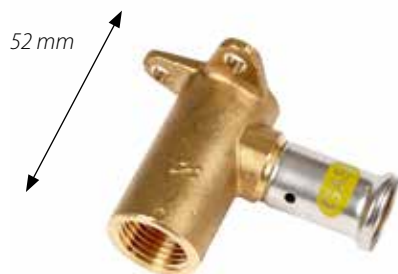

Backplate elbow female
Muurplaat binnendraad
Culasse femelle
Wandscheibe IG

Article number	Bag / Box	Type
2PG-1604	10 pc. / 50 pc.	16x1/2"
2PG-2004	10 pc. / 50 pc.	20x1/2"
2PG-2005	10 pc. / 50 pc.	20x3/4"
2PG-2605	5 pc. / 50 pc.	26x3/4"

Type: 2PG-K

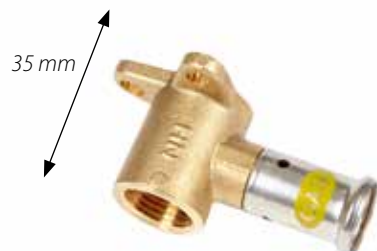

Backplate elbow female, short model
Muurplaat binnendraad, laag
Culasse femelle, modèle court
Wandscheibe IG, kurzes Modell

Article number	Bag / Box	Type
2PG-1604K	10 pc. / 50 pc.	16x1/2"



Type: 5PG



Elbow 90° male adapter
Knie 90° buitendraad
Coude 90° mâle
Winkel 90° AG

Article number	Bag / Box	Type
5PG-1604	10 pc. / 150 pc.	16x1/2"
5PG-2004	10 pc. / 100 pc.	20x1/2"
5PG-2005	10 pc. / 80 pc.	20x3/4"
5PG-2605	10 pc. / 60 pc.	26x3/4"

Type: 6PG



Elbow 90° female adapter
Knie 90° binnendraad
Coude 90° femelle
Winkel 90° IG

Article number	Bag / Box	Type
6PG-1604	10 pc. / 120 pc.	16x1/2"
6PG-2004	10 pc. / 120 pc.	20x1/2"
6PG-2005	10 pc. / 50 pc.	20x3/4"
6PG-2605	5 pc. / 50 pc.	26x3/4"

Type: 9PG



T-piece Gas
T-Stuk Gas
Pièce T Gaz
T-Stück Gas

Article number	Bag / Box	Type
9PG-161616	10 pc. / 60 pc.	16x16x16
9PG-202020	10 pc. / 50 pc.	20x20x20
9PG-262626	5 pc. / 30 pc.	26x26x26
9PG-323232*	1 pc. / 20 pc.	32x32x32

*TILL EXHAUSTION OF STOCK



Henco Brass Press

Henco Brass Press Fittings GAS

1 Type: 10PG



T-reduced centre
T-verlopend
Pièce en T réduit
T-reduziert

Article number	Bag / Box	Type
10PG-201620	10 pc. / 50 pc.	20x16x26
10PG-262026	5 pc. / 30 pc.	26x20x26

2 3 4 5 6 7 8 9 Type: 11PG



T-branch and line reduced
T-2x verlopend
Pièce en T 2x réduit
T-2x reduziert

Article number	Bag / Box	Type
11PG-201616*	10 pc. / 50 pc.	20x16x16

**TILL EXHAUSTION OF STOCK*

10 11 12 Type: 13PG



T-female centre
T-binnendraad
Pièce en T femelle
T-IG

Article number	Bag / Box	Type
13PG-200420	10 pc. / 50 pc.	20x1/2"x20
13PG-260426	5 pc. / 30 pc.	26x1/2"x26



Type: 15PG



Straight coupling
Perssok
Manchon
Kupplung

Article number	Bag / Box	Type
15PG-1616	10 pc. / 200 pc.	16x16
15PG-2020	10 pc. / 140 pc.	20x20
15PG-2626	5 pc. / 80 pc.	26x26
15PG-3232	5 pc. / 50 pc.	32x32

Type: 16PG



Reducing coupling
Verloopstuk
Réduction
Kupplung-reduziert

Article number	Bag / Box	Type
16PG-2016	10 pc. / 150 pc.	20x16
16PG-2620	5 pc. / 80 pc.	26x20
16PG-3226	5 pc. / 40 pc.	32x26

Type: 17PG



Straight male adapter
Puntstuk
Raccord droit mâle
Übergangsfitting AG

Article number	Bag / Box	Type
17PG-1604	10 pc. / 150 pc.	16x1/2"
17PG-2004	10 pc. / 150 pc.	20x1/2"
17PG-2005	10 pc. / 150 pc.	20x3/4"
17PG-2605	5 pc. / 80 pc.	26x3/4"
17PG-2606	5 pc. / 80 pc.	26x1"
17PG-3206	5 pc. / 50 pc.	32x1"

1

2

3

4

5

6

7

8

9

10

11

12



Henco Brass Press

Henco Brass Press Fittings GAS

Type: 18PG



Straight female adapter
Schroefbus
Raccord droit femelle
Übergangsfitting IG

Article number	Bag / Box	Type
18PG-1604	10 pc. / 150 pc.	16x1/2"
18PG-2004	10 pc. / 100 pc.	20x1/2"
18PG-2005	10 pc. / 100 pc.	20x3/4"
18PG-2605	5 pc. / 80 pc.	26x3/4"
18PG-2606	5 pc. / 70 pc.	26x1"
18PG-3206	5 pc. / 50 pc.	32x1"

Type: 30PG



Press-fit adapter to copper press compression
Overgangstuk Henco pers x koperbuis knelkoppeling
Manchon à sertir Henco vers tube de cuivre manchon à visser
Pressfitting x Klemmverbinder für Kupferrohr

Article number	Bag / Box	Type
30PG-1615S-2	2 pc. / 100 pc.	16x15
30PG-2022S	10 pc. / 100 pc.	20x22
30PG-2622S	10 pc. / 80 pc.	26x22

Type: 36PG



Press-fit adapter to copper press (V, M & SA profile)
Overgangstuk Henco pers naar koper pers (V, M & SA profiel)
Manchon à sertir Henco vers cuivre à sertir (profil M, V & SA)
Pressfitting Henco zu Pressfitting für Kupferrohr (CuSi)

Article number	Bag / Box	Type
36PG-1615P	10 pc. / 150 pc.	16x15Cu
36PG-2015P	10 pc. / 120 pc.	20x15Cu
36PG-2022P	10 pc. / 120 pc.	20x22Cu
36PG-2615P	10 pc. / 100 pc.	26x15Cu
36PG-2622P	10 pc. / 100 pc.	26x22Cu





Henco Brass Compression

Henco Brass Compression Fittings

Type: 1



Straight male adapter
Puntstuk
Raccord droit mâle
Kupplung AG

Article number	Bag / Box	Type
1-1403C-S**	10 pc. / 250 pc.	14x3/8"
1-1604-S	10 pc. / 250 pc.	16x1/2"
1-1804-S	10 pc. / 150 pc.	18x1/2"
1-1805*	10 pc. / 150 pc.	18x3/4"
1-2004-S	10 pc. / 120 pc.	20x1/2"
1-2004-ZS	10 pc. / 120 pc.	20x1/2"
1-2005-S	10 pc. / 150 pc.	20x3/4"
1-2605-S	5 pc. / 80 pc.	26x3/4"
1-2606-S	5 pc. / 80 pc.	26x1"
1-3206-S	5 pc. / 50 pc.	32x1"

**TILL EXHAUSTION OF STOCK*

***For fuel oil only*

Type: 2



Straight coupling
Doorverbinder recht
Manchon
Kupplung doppelt

Article number	Bag / Box	Type
2-1616-S	10 pc. / 200 pc.	16x16
2-2020-S	10 pc. / 120 pc.	20x20

Type: 3



Straight female adapter
Schroefbus
Raccord droit femelle
Kupplung IG

Article number	Bag / Box	Type
3-1604-S	10 pc. / 200 pc.	16x1/2"
3-1804-S	10 pc. / 120 pc.	18x1/2"
3-2004-S	10 pc. / 120 pc.	20x1/2"
3-2005-S	10 pc. / 120 pc.	20x3/4"
3-2605-S	5 pc. / 60 pc.	26x3/4"
3-2606-S	5 pc. / 50 pc.	26x1"

Type: 4



Elbow 90°
Knie 90°
Coude 90° mâle
Winkel 90°

Article number	Bag / Box	Type
4-1616-S	10 pc. / 150 pc.	16x16
4-2020-S	10 pc. / 60 pc.	20x20
4-2626-S	5 pc. / 40 pc.	26x26

Henco Brass Compression

Henco Brass Compression Fittings



Type: 5



Elbow 90° male adapter
Knie 90° buitendraad
Coude 90° mâle
Winkel 90° AG

Article number	Bag / Box	Type
5-1804*	10 pc. / 150 pc.	18x1/2"
5-1604-S	10 pc. / 150 pc.	16x1/2"
5-2005-S	10 pc. / 100 pc.	20x3/4
5-2606-S	5 pc. / 40 pc.	26x1

**TILL EXHAUSTION OF STOCK*

Type: 6



Elbow 90° female adapter
Knie 90° binnendraad
Coude 90° femelle
Winkel 90° IG

Article number	Bag / Box	Type
6-1604-S	10 pc. / 150 pc.	16x1/2"
6-1804*	10 pc. / 90 pc.	18x1/2"
6-2004-S	10 pc. / 80 pc.	20x1/2"
6-2005-S	10 pc. / 80 pc.	20x3/4"

**TILL EXHAUSTION OF STOCK*

Type: 7



Backplate elbow with branch connection
Sanitair muurplaat binnendraad
Culasse pour sanitaire femelle
Sanitär Wandscheibe

Article number	Bag / Box	Type
7-1604-S	10 pc. / 80 pc.	16x1/2"

Type: 8



T-piece
T-stuk
Pièce en T
T-Stück

Article number	Bag / Box	Type
8-161616-S	10 pc. / 80 pc.	16x16x16

Type: 10



Nut, insert and jointing ring
Moer, insert en klemring
Ecrou, insert et bicône
Mutte, Stuthülse und Klemmring

Article number	Bag / Box	Type
10-1604SN*	10 pc. / 300 pc.	16x1/2

**TILL EXHAUSTION OF STOCK*



Henco Brass Compression

Henco Brass Compression Fittings

Type: 13-2



Nut, insert and jointing ring to copper compression
Adapter Henco buis naar messing knelverbinding
Raccord à visser cuivre vers multicouche
Verbindungsstück Kupfer Schraubfitting auf Henco

Article number	Bag / Box	Type
13-1415-2*	2 pc. / 150 pc.	14x15 Cu
13-1615A-2*	2 pc. / 150 pc.	16x15 Cu
13-1615HA-2	2 pc. / 150 pc.	16x15 Cu
13-2022HA-2	2 pc. / 100 pc.	20x22 Cu
13-2628H-2	2 pc. / 80 pc.	26x28 Cu

**Nickel plated nut*

Type: 13-VH



Adapter for Henco compression to copper compression
Adapter Henco buis naar messing knelverbinding
Adapteur raccord à visser cuivre vers multicouche
Verbindungsstück für Henco Schraubfitting auf Kupfer Schraubfitting

Article number	Bag / Box	Type
13-V2622H-2	2 pc. / 50 pc.	26x22 Cu

Type: 24



Compression coupling Henco x copper tube
Overgangsstuk Henco knel x koperbuis knelverbinding
Raccord droit Henco x tube de cuivre manchon à visser
Gerade Fitting Henco x Klemmverbinder für Kupferrohr

Article number	Bag / Box	Type
24-1615-S	10 pc. / 200 pc.	16x15
24-2022	10 pc. / 100 pc.	20x22
24-2622*	5 pc. / 50 pc.	26x22

**TILL EXHAUSTION OF STOCK*

Type: EK



Nickel plated eurocone (3/4" F)
Euroconus schroefkoppeling (3/4" F)
Raccord à visser eurocone (3/4" F)
Schraubfitting Eurokonus (3/4" F)

Article number	Bag / Box	Type
EK12-2	2 pc. / 100 pc.	Ø12x3/4"
EK14-2	2 pc. / 100 pc.	Ø14x3/4"
EK16-2	2 pc. / 100 pc.	Ø16x3/4"
EK17-2	2 pc. / 100 pc.	Ø17x3/4"
EK18-2	2 pc. / 100 pc.	Ø18x3/4"
EK20-2	2 pc. / 100 pc.	Ø20x3/4"

Henco Brass Compression

Henco Brass Compression Fittings



Type: EK15



Eurocone (3/4" F) for copper tube 15mm
Euroconus-schroefkoppeling (3/4" F) voor koperbuis 15mm
Raccord à visser eurocone (3/4" F) pour tube de cuivre 15mm
Schraubfitting Eurokonus (3/4") für Kupferrohr 15mm

Article number	Box / Big Box	Type
EK15	25 pc. / 300 pc.	Ø15x3/4" EK

Type: SPLIT



Split olive for eurocone
Henco Klemring voor EK
Anneau de serrage pour raccordement eurocone
Klemring für EK

Article number	Bag	Type
SPLIT-14	10 pc.	Ø14
SPLIT-16	10 pc.	Ø16
SPLIT-20	10 pc.	Ø20

Type: SPLIT-S



Henco Split ring for compression fittings (not for EK)
Henco Klemring voor schroeffitting (Niet voor EK'S)
Anneau de serrage pour raccords à visser (pas pour EK)
Klemring für Schraubfitting (nicht für EK)

Article number	Bag	Type
SPLIT-S16	10 pc.	Ø16
SPLIT-S20	10 pc.	Ø20
SPLIT-S26	10 pc.	Ø26

Type: AB



Elbow 90° eurocone elbow (3/4" M)
Knie 90° voor euroconus-aansluiting (3/4" M)
Coude 90° pour raccordement eurocone (3/4" M)
Winkel 90° für Eurokonusanschluß (3/4" M)

Article number	Bag / Box	Type
AB1420*	10 pc. / 100 pc.	14x20

*TILL EXHAUSTION OF STOCK

Type: ABE



Elbow 90° eurocone (3/4" M) x 1/2" male adapter
Knie 90° buitendraad 1/2" x euroconus-aansluiting (3/4" M)
Coude 90° mâle 1/2" x raccordement eurocone (3/4" M)
Winkel 90° AG 1/2 x Eurokonusanschluss (3/4" M)

Article number	Bag / Box	Type
ABEK04*	10 pc. / 150 pc.	1/2"x3/4" for EK

*TILL EXHAUSTION OF STOCK



Henco Brass Compression

Henco Brass Compression Fittings

Type: AT



Eurocone equal T-piece
T-stuk voor euroconus-aansluiting (3/4" M)
Pièce en T pour raccordement eurocone (3/4" M)
T-Stück für Eurokonusanschluß (3/4" M)

Article number	Bag / Box	Type
AT1420*	10 pc. / 100 pc.	3/4"x3/4"x3/4" for EK

**TILL EXHAUSTION OF STOCK*

Type: AD



Eurocone straight coupling (3/4" M)
Overgangstuk met 2x euroconus-aansluiting (3/4" M)
Mamelon 2x raccordement eurocone (3/4" M)
Nippel für 2x Eurokonusanschluss

Article number	Bag / Box	Type
AD-EKEK	10 pc. / 250 pc.	3/4"x3/4" for EK

Type: AN



Straight eurocone connection (3/4" M) to 1/2" male adapter
Recht overgangsstuk 1/2" M met O-ring en EK-aansluiting (3/4" M)
Manchon droit mâle 1/2" avec joint torique et eurocone
Nippel AG 1/2" mit O-ring und Eurokonusanschluss (3/4" M)

Article number	Bag / Box	Type
AN1420	10 pc. / 250 pc.	1/2"x3/4" for EK

Type: 3EK



Double backplate elbow female, 2x eurocone connection
Double backplate elbow female, 2x eurocone connection
Culasse double, 2x raccordement eurocone
Wandscheibe doppelt IG, 2x Eurokonusanschluss

Article number	Bag / Box	Type
3EK-050405	5 pc. / 40 pc.	3/4"x1/2"x3/4"

Type: WBS



Wall Box - compression
Wall Box - schroef
Wall Box - compression
Wall Box - Schraub

Article number	Box / Big Box	Type
WBS-1604-RO	10 pc. / 300 pc.	16x1/2" red
WBS-1604-BL	10 pc. / 300 pc.	16x1/2" blue

Without mounting bracket WB-plate



Instruction video

Henco Brass Compression

Henco Brass Compression Fittings



Type: WB-PLATE

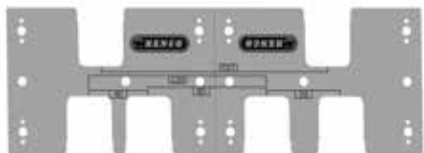

Wall Box mounting bracket
Wall Box mounting bracket
Wall Box plaque de montage
Wall Box Montage Bügel

Article number	Box / Big Box	Type
WBPL-X	10 pc. / 60 pc.	GALV. STEEL

Type: 2C



Wallplate horizontal 1/2"x1/2"
Horizontale/rechtdoor muurplaat 1/2"x1/2"
Culasse horizontale 1/2"x1/2"
Wandscheibe horizontal 1/2"x1/2"

Article number	Bag / Box	Type
2C-0404	10 pc. / 100 pc.	1/2"

1

2

3

4

5

6

7

8

9

10

11

12



Henco Manifolds

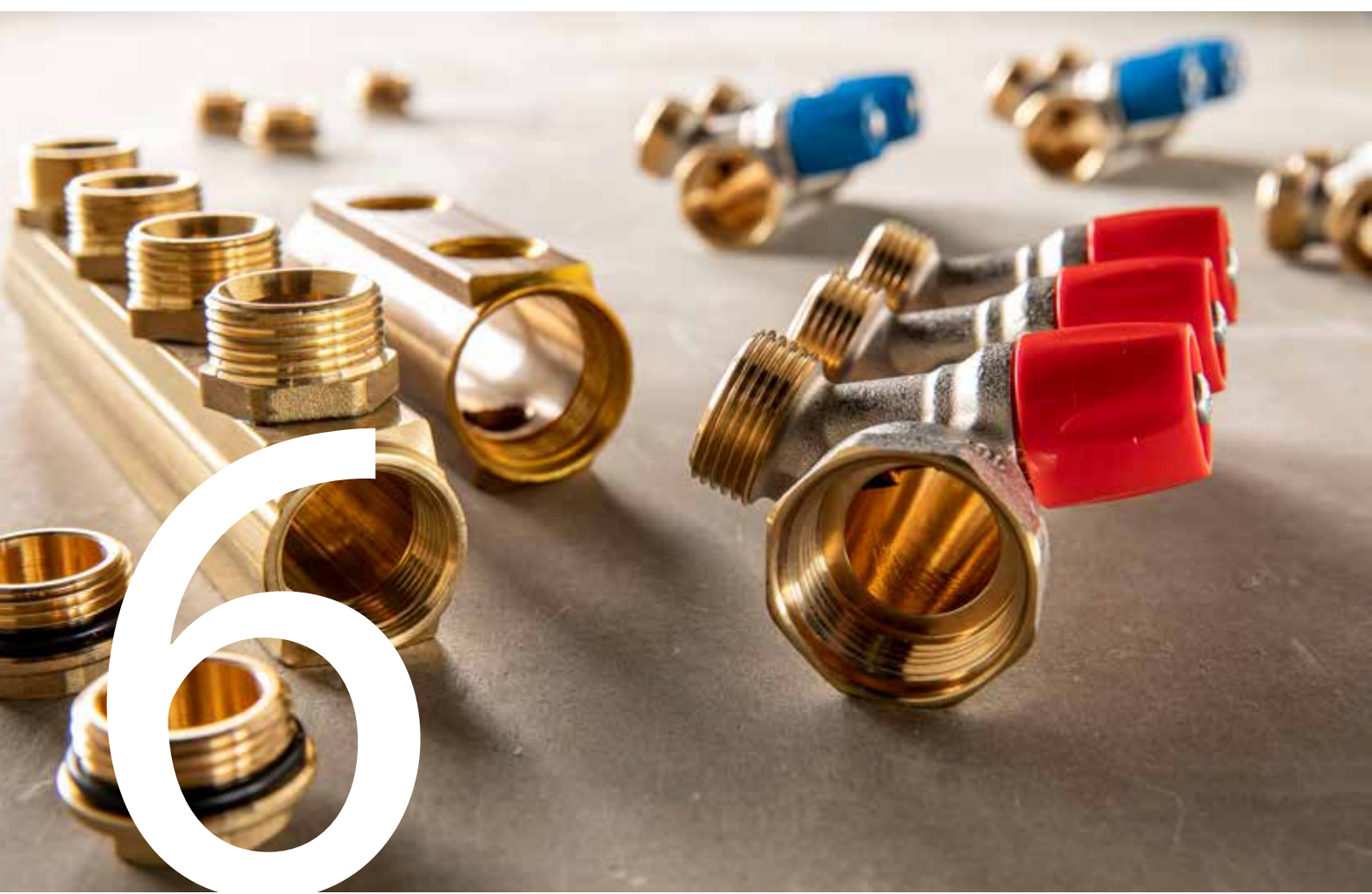

	<i>Page</i>
<i>Henco Full Flow Manifold</i>	<i>101</i>
<i>Henco Brass Manifolds</i>	<i>106</i>



POSSIBLE COMBINATIONS

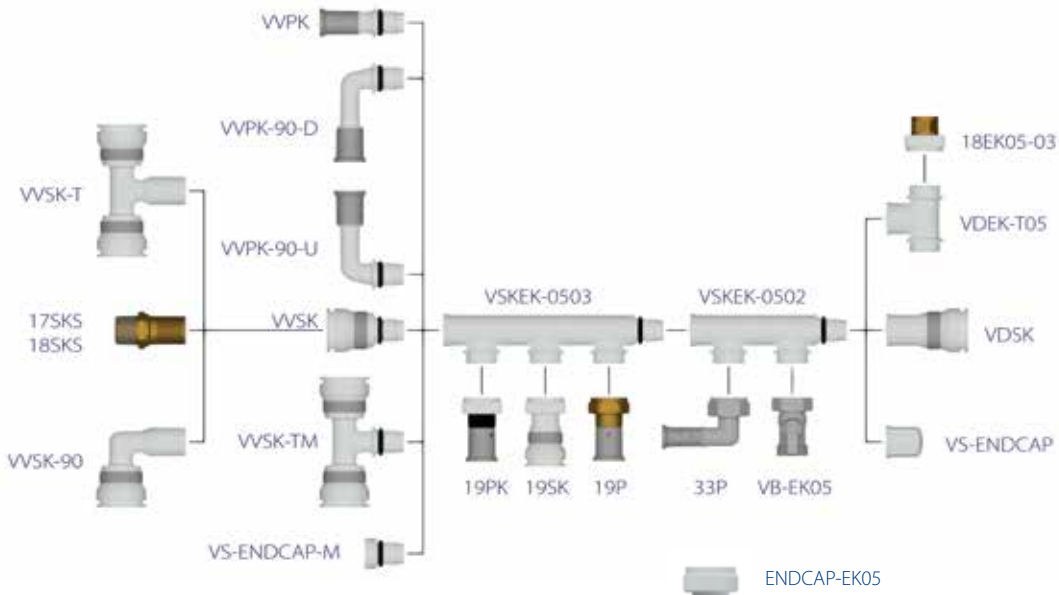

Type: VSKEK-0502



2-group basic part with 2 eurocone connections 3/4"
 2-groeps basis deel met 2 euroconus-aansluitingen 3/4"
 Section de base à 2 groupes avec 2 raccords eurocone 3/4"
 2-gruppiges Basisprofil mit 2 Eurokonusanschlüssen 3/4"

Article number	Bag / Box	Type
VSKEK-0502	10 pc. / 30 pc.	2x3/4"

Type: VSKEK-0503

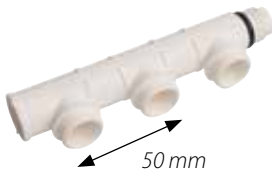

3-group basic part with 3 eurocone connections 3/4"
 3-groeps basis deel met 3 euroconus-aansluitingen 3/4"
 Section de base à 3 groupes avec 3 raccords eurocone 3/4"
 3-gruppiges Basisprofil mit 3 Eurokonusanschlüssen 3/4"

Article number	Bag / Box	Type
VSKEK-0503	10 pc. / 30 pc.	3x3/4"

Type: VSKEK-ISO



Full Flow Manifold insulation 12 outlets
 Full Flow Manifold isolatie 12 uitgangen
 Isolation du collecteur Full Flow 12 sorties
 Isolierung des Full Flow verteilers 2 ausgänge

Article number	Bag / Box	Type
VSKEK-ISO-12	1 pc. / 50 pc.	12 outlets

Type: 19SK



Push fitting with eurocone connection
 Steekkoppeling met euroconus-aansluiting
 Raccord push fit avec eurocone
 Steckkupplung mit Eurokonus

Article number	Bag / Box	Type
19SK-1505*	10 pc. / 80 pc.	15x3/4" EK
19SK-1605	10 pc. / 80 pc.	16x3/4" EK
19SK-2005	10 pc. / 80 pc.	20x3/4" EK

**Not suited for embedding in floors and walls*



Henco Manifolds

Henco Full Flow Manifold

Type: 26SK



Push fitting with swivel and flat sealing
 Steekkoppeling met wartel en vlakke dichting
 Raccord push fit avec raccord ecrou etanchéité plate
 Steckkupplung mit Drehbar und flach Versiegelung

Article number	Bag / Box	Type
26SK-1605*	10 pc. / 80 pc.	16x3/4
26SK-2005*	10 pc. / 80 pc.	20x3/4

**TILL EXHAUSTION OF STOCK*

Type: VVSK



Straight entry piece
 Voeding voor verdeler
 Départ collecteur
 Eingang für Verteiler

Article number	Bag / Box	Type
VVSK-20	10 pc. / 80 pc.	20
VVSK-26	10 pc. / 70 pc.	26

Type: VVSK-TM



T-piece for supply for Vision manifold
 Aanvoer T-stuk voor Vision manifold
 Départ pièce en T collecteur Vision
 T-Stück für Vorlauf für Vision Verteiler

Article number	Bag / Box	Type
VVSK-T26M26	5 pc. / 20 pc.	26-26
VVSK-T20M20	10 pc. / 30 pc.	20-20

Type: 17SKS



Straight nipple male
 Puntstuk
 Raccord droit mâle
 Übergangsfitting AG

Article number	Bag / Box	Type
17SKS-2004	5 pc. / 150 pc.	20x1/2"
17SKS-2005	5 pc. / 150 pc.	20x3/4"
17SKS-2604	5 pc. / 100 pc.	26x1/2"
17SKS-2605	5 pc. / 100 pc.	26x3/4"

Applicable with HENCO Vision fittings & full flow manifolds

Type: 18SKS



Straight nipple female
 Recht aansluitstuk binnendraad
 Raccord droit femelle
 Übergangsfitting IG

Article number	Bag / Box	Type
18SKS-2004	5 pc. / 150 pc.	20x1/2"
18SKS-2005	5 pc. / 100 pc.	20x3/4"
18SKS-2604	5 pc. / 100 pc.	26x1/2"
18SKS-2605	5 pc. / 80 pc.	26x3/4"

Applicable with HENCO Vision fittings & full flow manifolds



Type: VVSK-90



Elbow 90° for manifold
Knie 90° voor verdeler
Coude 90° pour collecteur
Winkel 90° für Verteiler

Article number	Bag / Box	Type
VVSK-20-90	10 pc. / 70 pc.	20-90°
VVSK-26-90	10 pc. / 50 pc.	26-90°

Type: VVSK-T



T-piece for manifold
T-stuk voor verdeler
Pièce en T pour collecteur
T-Stück für Verteiler

Article number	Bag / Box	Type
VVSK-T202020	10 pc. / 40 pc.	20-20-20
VVSK-T262626	10 pc. / 20 pc.	26-26-26

Type: VS-ENDCAP



Stop end female for manifold
Eindstop binnendraad voor verdeler
Bouchon femelle pour collecteur
Endkappe IG für Verteiler

Article number	Bag / Box	Type
VS-ENDCAP	10 pc. / 180 pc.	F

Type: 18EK05



Connection for synthetic manifold 3/8"
Aansluiting voor kunststof verdeler 3/8"
Raccord à visser eurocone 3/8"
Verbindung für Verteiler kunststoff 3/8"

Article number	Bag / Box	Type
18EK05-03	2 pc. / 200 pc.	EKx3/8"

Type: VDEK-T05



T-connection piece - 2x eurocone
T-aansluitstuk voor verdeler - 2x euroconus
Raccord en T pour collecteur - 2x eurocone
T-Stück für Verlauf - 2x Eurokonus

Article number	Bag / Box	Type
VDEK-T05	10 pc. / 50 pc.	



Henco Manifolds

Henco Full Flow Manifold

1

Type: VS-ENDCAP-M

2

3

4

5



Stop end male for manifold
Eindstop buitendraad voor verdeler
Bouchon mâle pour collecteur
Endkappe AG für Verteiler

Article number	Bag / Box	Type
VS-ENDCAP-M	10 pc. / 150 pc.	M

6

Type: ENDCAP-EK

7

8

9

10



Stop end eurocone for manifold
Eindstop euroconus voor verdeler
Bouchon eurocone pour collecteur
Endkappe Eurokonus für Verteiler

Article number	Bag / Box	Type
ENDCAP-EK05	10 pc. / 200 pc.	3/4"

11

Type: VDSK

12



Straight female adapter for manifold or manifold extension
Doorverbinder voor montage op verdeler of verlengstuk
Manchon pour bout de collecteur
Ausgang für Verteiler

Article number	Bag / Box	Type
VDSK-20	10 pc. / 80 pc.	20
VDSK-26	10 pc. / 60 pc.	26

Type: SK-STOPCLIP



Reusable stop and clip for push fit connection
Herbruikbare stop en clip passend in een steekkoppeling
Bouchon et clip réutilisables pour connection push fit
Stopfen und clip für Steckanschluss, wieder verwendbar

Article number	Bag / Box	Type
SK-STOPCLIP16	10 pc. / 120 pc.	16
SK-STOPCLIP20	10 pc. / 100 pc.	20
SK-STOPCLIP26	10 pc. / 80 pc.	26



Type: SK-B05



Bracket for full flow manifolds
Montagebeugel voor full flow manifolds
Double support pour full flow manifolds
Halter für full flow manifolds

Article number	Bag / Box	Type
SK-B05	1 pc. / 100 pc.	B05

Type: VVPK



Straight entry piece - Press
Voeding voor verdeler - Pers
Arrivée pour collecteur - à sertir
Eingang für verteiler - Press

Article number	Bag / Box	Type
VVPK-20	10 pc. / 80 pc.	20
VVPK-26	10 pc. / 70 pc.	26

Type: VVPK90-D



Bend entry piece down 90° - press
Voeding verdeler bocht 90° toevoer onder - pers
Départ dessous pour collecteur coude 90° - à sertir
Eingang für Verteiler Winkel 90° nieder - press Article number Bag / Box T

Article number	Bag / Box	Type
VVPK90-20-D	10 pc. / 70 pc.	20-90° Down
VVPK90-26-D	10 pc. / 50 pc.	26-90° Down

Type: VVPK90-U



Bend entry piece up 90° - press
Voeding verdeler bocht 90° graden boven - pers
Départ par dessus pour collecteur coude 90° - à sertir
Eingang für Verteiler Winkel 90° oben - press

Article number	Bag / Box	Type
VVPK90-20-U	10 pc. / 70 pc.	20-90° Up
VVPK90-26-U	10 pc. / 50 pc.	26-90° Up

1

2

3

4

5

6

7

8

9

10

11

12



Henco Manifolds

Henco Brass Manifolds

Type: VB-EK05



Ball valve, 2x eurocone connection
Bolkraan, 2x euroconus aansluiting
Vanne d'arrêt, 2x raccordement eurocone
Kugelhahn, 2x Eurokonus

Article number	Box / Big Box	Type
VB-EK05	25 pc. / 200 pc.	3/4" EK x 3/4" EK

Type: VB-HANDLE



Handles for VB-articles
Handvaten voor VB-artikels
Manche pour VB-article
Handgriff für VB-article

Article number	Bag / Box	Type
VB-HANDLE-RED	1 pc. / 100 pc.	Red
VB-HANDLE-BLUE	1 pc. / 100 pc.	Blue

Type: VB05



Manifold 3/4" with ball valves + EK connection
Verdeler 3/4" met bolkraan + EK-uitgangen
Collecteur 3/4" avec vanne à sphère + EK connexion
Verteiler 3/4" mit Kugelhahnset + EK Verbindung

Article number	Box / Big Box	Type
VB050502-BLAUW	5 pc. / 50 pc.	3/4"x2xEK14,16,18 & 20 blue
VB050502-ROOD	5 pc. / 50 pc.	3/4"x2xEK14,16,18 & 20 red
VB050503-BLAUW	5 pc. / 25 pc.	3/4"x3xEK14,16,18 & 20 blue
VB050503-ROOD	5 pc. / 25 pc.	3/4"x3xEK14,16,18 & 20 red
VB050504-BLAUW	4 pc. / 20 pc.	3/4"x4xEK14,16,18 & 20 blue
VB050504-ROOD	4 pc. / 20 pc.	3/4"x4xEK14,16,18 & 20 red

Type: VB06



Manifold 1" with ball valve + EK connections
Verdeler 1" met bolkraan + EK aansluitingen
Collecteur 1" avec vanne à sphère + EK connexion
Verteiler 1" mit Kugelhahnset + EK Verbindung

Article number	Box / Big Box	Type
VB060502-BLAUW	5 pc. / 40 pc.	1"x2xEK14,16,18 & 20 blue
VB060502-ROOD	5 pc. / 40 pc.	1"x2xEK14,16,18 & 20 red
VB060503-BLAUW	5 pc. / 25 pc.	1"x3xEK14,16,18 & 20 blue
VB060503-ROOD	5 pc. / 25 pc.	1"x3xEK14,16,18 & 20 red
VB060504-BLAUW	4 pc. / 20 pc.	1"x4xEK14,16,18 & 20 blue
VB060504-ROOD	4 pc. / 20 pc.	1"x4xEK14,16,18 & 20 red

Type: VBS



Plug M with O-ring VBS Manifold
Blindstop M met O-ring VBS verdeler
Bouchon M pour VBS collecteur avec O-ring
Stopf M für Verteiler VBS mit O-Ring

Article number	Bag / Box	Type
VBS-05	10 pc. / 250 pc.	3/4"
VBS-06	10 pc. / 250 pc.	1" female



Type: VBS05



Manifold 3/4" with valve + EK + O-ring connection/alignment
Verdeler 3/4" met kraan + EK + O-ring aansluiting/uitlijning
Bouchon pour VBS collecteur avec O-ring
Stopf für verteiler VBS mit O-ring

Article number	Bag / Box	Type
VBS050502-BL	1 pc. / 20 pc.	3/4"x2xEK14,16,18 & 20 blue
VBS050502-RO	1 pc. / 20 pc.	3/4"x2xEK14,16,18 & 20 red
VBS050502-GR*	1 pc. / 20 pc.	3/4"x2xEK14,16,18 & 20 green
VBS050503-BL	1 pc. / 15 pc.	3/4"x3xEK14,16,18 & 20 blue
VBS050503-RO	1 pc. / 15 pc.	3/4"x3xEK14,16,18 & 20 red
VBS050503-GR*	1 pc. / 15 pc.	3/4"x3xEK14,16,18 & 20 green
VBS050504-BL	1 pc. / 10 pc.	3/4"x4xEK14,16,18 & 20 blue
VBS050504-RO	1 pc. / 10 pc.	3/4"x4xEK14,16,18 & 20 red
VBS050504-GR*	1 pc. / 10 pc.	3/4"x4xEK14,16,18 & 20 green

*Available on demand

Type: VBS06



Manifold 1" with valve + EK + O-ring connection/alignment
Verdeler 1" met kraan + EK + O-ring aansluiting/uitlijning
Collecteur 1" avec vanne + EK + O-ring alignement
Verteiler 1" mit Hahne + EK + O-ring Verbindung/Ausrichtung

Article number	Bag / Box	Type
VBS060502-RO	1 pc. / 20 pc.	1"x2xEK14,16,18 & 20 red
VBS060502-BL	1 pc. / 20 pc.	1"x2xEK14,16,18 & 20 blue
VBS060503-RO	1 pc. / 15 pc.	1"x3xEK14,16,18 & 20 red
VBS060503-BL	1 pc. / 15 pc.	1"x3xEK14,16,18 & 20 blue
VBS060504-RO	1 pc. / 10 pc.	1"x4xEK14,16,18 & 20 red
VBS060504-BL	1 pc. / 10 pc.	1"x4xEK14,16,18 & 20 blue

Type: VBS-F



Manifold plug F for VBS manifold
Blindstop F voor VBS verdeler
Bouchon F pour VBS collecteur
Stopf F für Verteiler VBS Article number B

Article number	Bag / Box	Type
VBS-05F	10 pc. / 250 pc.	3/4" female
VBS-06F	10 pc. / 250 pc.	1" female

Type: 17VBS



Straight adapter VBS manifold
Recht aansluitstuk VBS verdeler
Raccord droit VBS collecteur
Übergangsfitting AG VBS Verteiler

Article number	Bag / Box	Type
17VBS-2005	10 pc. / 100 pc.	20x3/4"
17VBS-2605	5 pc. / 80 pc.	26x3/4"
17VBS-2606	5 pc. / 80 pc.	26x1"

Type: 6VBS



Elbow 90° female iron adapter for VBS manifold
Knie 90° voor VBS verdeler
Coude 90° femelle pour collecteur VBS
Winkel 90° IG für VBS Verteiler

Article number	Bag / Box	Type
6VBS-2005	10 pc. / 50 pc.	20x3/4"
6VBS-2605	5 pc. / 50 pc.	26x3/4"



Henco Manifolds

Henco Brass Manifolds

Type: SK-B05



Bracket for manifolds
Montagebeugel voor verdelers
Double support pour collecteurs
Halter für Verteiler

Article number	Bag / Box	Type
SK-B05	1 pc. / 100 pc.	B05

Type: V-06

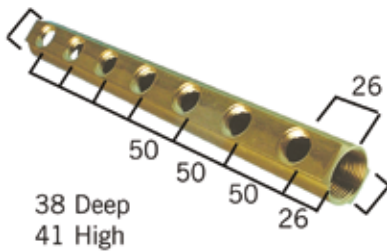

Manifold 1", 1/2" female thread, 3/8" air vent hole
Verdeler 1", 1/2" aansluitingen, 3/8" ontluichtingsopening
Collecteur 1", connexion 1/2" femelle, connexion 3/8" pour purgeur
Verteiler 1", 1/2" IG, 3/8" Loch für Entlüftung

Article number	Bag / Box	Type
V-060402*	1 pc. / 8 pc.	1" 2x1/2" x 3/8"
V-060404*	1 pc. / 30 pc.	1" 4x1/2" x 3/8"
V-060405*	1 pc. / 28 pc.	1" 5x1/2" x 3/8"
V-060406*	1 pc. / 30 pc.	1" 6x1/2" x 3/8"

**TILL EXHAUSTION OF STOCK*

Type: V-05-Z

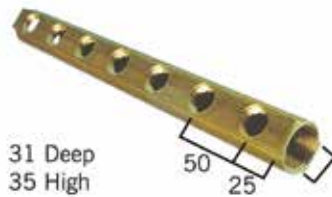

Manifold 3/4", 1/2" female thread
Verdeler 3/4", 1/2" aansluitingen
Collecteur 3/4", connexion 1/2" femelle
Verteiler 3/4", 1/2" IG

Article number	Bag / Box	Type
V-050404-Z	1 pc. / 6 pc.	3/4" 4x1/2"

Type: VEK-06



Manifold 1" with EK connections and one 3/8" air vent hole
Verdeler 1" met EK-aansluitingen en 3/8" ontluichtingsopening
Collecteur 1" avec des raccordements eurocone et un trou 3/8" pour purgeur
Verteiler 1" mit EK-Anschlüssen und 3/8" Loch für Entlüftung

Article number	Bag / Box	Type
VEK-060502	1 pc. / 48 pc.	1" 2x3/4" x 3/8"
VEK-060503	1 pc. / 32 pc.	1" 3x3/4" x 3/8"
VEK-060504	1 pc. / 20 pc.	1" 4x3/4" x 3/8"
VEK-060505	1 pc. / 21 pc.	1" 5x3/4" x 3/8"
VEK-060507	1 pc. / 15 pc.	1" 7x3/4" x 3/8"
VEK-060508	1 pc. / 15 pc.	1" 8x3/4" x 3/8"

Type: VEK-06-Z

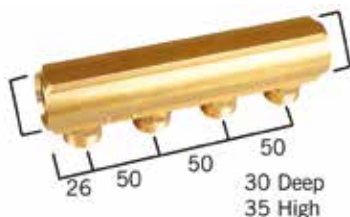

Manifold 1" with eurocone connections
Verdeler 1" met euroconus-aansluitingen
Collecteur 1" avec des raccordements eurocone
Verteiler 1" mit Eurokonus-Anschlüssen

Article number	Bag / Box	Type
VEK-060503-Z	1 pc. / 20 pc.	1" 3x3/4"
VEK-060504-Z	1 pc. / 16 pc.	1" 4x3/4"
VEK-060505-Z	1 pc. / 21 pc.	1" 5x3/4"
VEK-060506-Z	1 pc. / 20 pc.	1" 6x3/4"
VEK-060507-Z	1 pc. / 20 pc.	1" 7x3/4"
VEK-060508-Z	1 pc. / 15 pc.	1" 8x3/4"
VEK-060509-Z	1 pc. / 10 pc.	1" 9x3/4"
VEK-060510-Z	1 pc. / 10 pc.	1" 10x3/4"



Type: H-0212



Insulated manifold bracket (pairs)
Ophangbeugel dubbel met isolatie voor alle verdelers
Support double avec isolation pour tous les collecteurs
Verteiler-Halter mit Isolierung doppelt für alle Verteiler

Article number	Bag / Box	Type
H-0212*	2 pc. / 50 pc.	3/4" - 1"

*Sold per set of 2

Type: H-0212-S



Insulated manifold bracket (single)
Ophangbeugel enkel met isolatie voor alle verdelers
Support simple avec isolation pour tous les collecteurs
Verteiler-Halter mit Isolierung einfach für alle Verteiler

Article number	Bag / Box	Type
H-0212-S	2 pc. / 50 pc.	3/4" - 1"
H-0212-C*	2 pc. / 2x25 pc.	3/4" - 1"

*Sold per set of 2

Type: VS REDUCTIE



Manifold reducer with O-ring
Reductie met O-ring voor verdeler
Réduction avec O-ring pour collecteur
Reduktion für Verteiler mit O-ring

Article number	Bag / Box	Type
VS-0504	10 pc. / 50 pc.	3/4"x1/2"
VS-0604	10 pc. / 250 pc.	1"x1/2"
VS-0605	10 pc. / 250 pc.	1"x3/4"

Type: VS BLINDSTOP



Manifold plug
Blindstop voor verdeler
Bouchon pour collecteur
Stopfen für Verteiler

Article number	Bag / Box	Type
VS-05	10 pc. / 50 pc.	3/4"
VS-06	10 pc. / 200 pc.	1"
VS-07	10 pc. / 200 pc.	5/4"



Henco Valves



	<i>Page</i>
<i>Henco Inox Valves</i>	<i>111</i>
<i>Henco Brass Valves</i>	<i>112</i>



Type: BAP-FFV (press x press) (INOX 316 L)



Inox ball valve with handle, press
 Inox bolkraan met handvat, pers
 Vanne en acier inoxydable, presse x presse
 Kugelhahn aus Edelstahl, Press x Press

Article number	Bag / Box	Type
BAP-FFV1616	1 pc. / 25 pc.	16x16
BAP-FFV2020	1 pc. / 25 pc.	20x20
BAP-FFV2626	1 pc. / 15 pc.	26x26
BAP-FFV3232	1 pc. / 15 pc.	32x32

Type: BAP-FFV (press x female thread) (INOX 316 L)



Inox ball valve with handle, press x female
 Inox bolkraan met handvat, pers x vrouwelijk
 Vanne en acier inoxydable, presse x femelle
 Kugelhahn aus Edelstahl, Press x IG

Article number	Bag / Box	Type
BAP-FFV1604	1 pc. / 25 pc.	16 x 1/2"
BAP-FFV1805	1 pc. / 25 pc.	18 x 3/4"
BAP-FFV2005	1 pc. / 25 pc.	20 x 3/4"
BAP-FFV2605	1 pc. / 15 pc.	26 x 3/4"
BAP-FFV2606	1 pc. / 15 pc.	26 x 1"
BAP-FFV3207	1 pc. / 10 pc.	32 x 1 1/4"

Type: BAP-FFV-Z (press x swivel) (INOX 316 L)



Inox ball valve with handle, press x swivel nut
 Inox bolkraan met handvat, pers x wartelmoer
 Vanne en acier inoxydable, presse x ecrou
 Kugelhahn aus Edelstahl, Press x Anschlussverschraubung

Article number	Bag / Box	Type
BAP-FFV16Z05	1 pc. / 25 pc.	16x3/4"
BAP-FFV20Z05	1 pc. / 25 pc.	20x3/4"
BAP-FFV26Z05	1 pc. / 25 pc.	26x3/4"
BAP-FFV26Z06	1 pc. / 15 pc.	26x1"
BAP-FFV32Z06	1 pc. / 15 pc.	32 x 1"

Type: BAP-FFV-EK (press x eurocone) (INOX 316 L)



Inox ball valve with handle, press x EK
 Inox bolkraan met handvat, pers x EK
 Vanne en acier inoxydable, presse x eurocone
 Kugelhahn aus Edelstahl, Press x Eurokonus

Article number	Bag / Box	Type
BAP-FFV1605EK	1 pc. / 25 pc.	16x3/4" EK
BAP-FFV2005EK	1 pc. / 25 pc.	20x3/4" EK
BAP-FFV2605EK	1 pc. / 15 pc.	26x3/4" EK



Henco Valves

Henco Brass Valves

Type: BAP-H



Ball valve with handle, 2x pressfitting
 Bolkraan met handvat, 2x perskoppeling
 Vanne d'arrêt à sertir
 Kugelhahnset mit Handgriff, 2x Pressfitting

Article number	Box / Big Box	Type
BAP-H1616	8 pc. / 80 pc.	16x16
BAP-H2020	8 pc. / 80 pc.	20x20
BAP-H2626	8 pc. / 80 pc.	26x26
BAP-H3232	5 pc. / 25 pc.	32x32

Type: BAP-SV



Stopvalve DN10
 Stopbolkraan DN10
 Vanne d'arrêt DN10
 Stopvalve DN10

Article number	Bag / Box	Type
BAP-SV1610S	10 pc. / 100 pc.	16 x 10

Type: VK-EK05



Ball valve, 2 x eurocone connection
 Bolkraan, 2 x euroconus aansluiting
 Vanne d'arrêt, 2 x raccordement eurocone
 Kugelhahn, 2 x Eurokonus

Article number	Box / Big Box	Type
VB-EK05	25 pc. / 200 pc.	3/4" EK x 3/4" EK

Type: 41S



Brass Vision coupling with valve F-connection
 Messing Vision koppeling met F-aansluiting
 Connecteur Vision F
 Vision Fittung mit F-Verbindung

Article number	Bag / Box	Type
41S-20	10 pc. / 60 pc.	20
41S-26	10 pc. / 80 pc.	26

TILL EXHAUSTION OF STOCK

Type: 41SKS



Connection Vision coupling with valve F-connection
 Aansluitstuk Vision koppeling met F-aansluiting
 Raccord Vision connecteur Vision F
 Messing Übergang Vision Fittung mit F-Verbindung

Article number	Bag / Box	Type
41SKS-20	10 pc. / 80 pc.	20
41SKS-26	10 pc. / 80 pc.	26

TILL EXHAUSTION OF STOCK

Type: BA-F41



Built-in Ball Valve Fastec DN15
 Inbouwbolkraan Fastec DN15
 Vanne à sphère Fastec DN15
 Einbau Kugelhahnset Fastec DN15

Article number	Bag / Box	Type
BA-F41	1 pc. / 50 pc.	

TILL EXHAUSTION OF STOCK



- 1
- 2
- 3
- 4
- 5
- 6
- 7
- 8
- 9
- 10
- 11
- 12

Type: EK15



Eurocone (3/4" F) for copper tube 15mm
 Euroconus-schroefkoppeling (3/4" F) voor koperbuis 15mm
 Raccord à visser eurocone (3/4" F) pour tube de cuivre 15mm
 Schraubfitting Eurokonus (3/4") für Kupferrohr 15mm

Article number	Box / Big Box	Type
EK15	25 pc. / 300 pc.	Ø15x3/4" EK

Type: RADTH-VL



Thermostatic radiator valve head
 Thermostatisch regelement met vaste vloeistofvoeler
 Tête thermostat.à bulbe,équipée d un réglage de temp. limite
 Thermostatkopf mit festem flüssigkeitsfühler

Article number	Box / Big Box	Type
RADTH-VL*	10 pc. / 150 pc.	THERM

**TILL EXHAUSTION OF STOCK*

Type: RADNI



Nipple for H radiator block
 Nippel voor H-radiatorblok
 Vanne pour raccord radiateur (H&V)
 Nippel für H-Anschluss

Article number	Bag / Box	Type
RADNI-0504	10 pc. / 500 pc.	1/2"x3/4"

Type: RAD04-100V



Radiator connector with 3/4" eurocone connections, straight
 Onderblok met 3/4" euroconus-aansluitingen, recht
 Raccord radiateur, droit, eurocone
 Heizkörperanschluss 1/2" mit 3/4" Eurokonus-Anschlüssen, unten

Article number	Bag / Box	Type
RAD04-100V	1 pc. / 10 pc.	1/2"x3/4" EK



Henco Underfloor Heating



	<i>Page</i>
<i>Underfloor Heating Systems</i>	<i>115</i>
<i>Underfloor Heating Manifolds</i>	<i>122</i>
<i>Hencologic Wired</i>	<i>131</i>
<i>Hencologic Wireless</i>	<i>132</i>



Type: UFH-PRO



System plate without insulation
Noppenplaat zonder isolatie
Plaque à plot sans isolation
Systemplatte ohne Dämmung

Article number	Multipack	Type
UFH-PRO	13.44 m2	1400x800mm - 5kPa

**Pipe Ø16, centre-to-centre: multiple 50mm hor./ver.*

Type: UFH-ISOPRO11



System plate with 11mm EPS insulation
Noppenplaat met 11mm EPS Isolatie
Plaque à plot avec isolation EPS de 11mm
Systemplatte mit Dämmung Styropor 11mm

Article number	Multipack	Type
UFH-ISOPRO11	14.56 m2	1400x800mm - 75kPa R 0,31m ² K/W

**Pipe Ø16, centre-to-centre: multiple 50mm hor./ver.*

Type: UFH-ISOPRO30



System plate with 30mm EPS insulation and 28dB acoustic improvement
Noppenplaat met 30mm EPS isolatie, 28dB geluidsverbetering
Plaque à plot avec isolation EPS de 30mm, isolant acoustique 28dB
Systemplatte mit Dämmung Styropor 30mm, Trittschall verbesserung 28dB

Article number	Multipack	Type
UFH-ISOPRO30	7.84 m2	1400x800mm - 5kPa - 28dB - R 0,75m ² K/W

**Pipe Ø16, centre-to-centre: multiple 50mm hor./ver.*

Type: UFH-CASTMAT

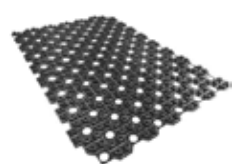

UFH castellated mat
UFH holle noppenplaat
UFH plaque à plot renforcée
Systemplatte ausgef. Rohrhaltenop.

Article number	Pallet	Type
UFH-CASTMAT16	99 pc.	Ø16, 1050 x 750 x 17 mm

Type: UFH-RAS

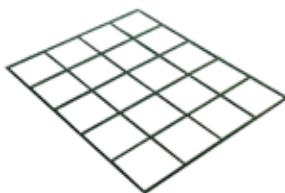

Galvanized steel mesh
Stalen draadmat verzinkt
Treillis en acier galvanisé
Trägermatte aus Eisen verzinkt

Article number	Multipack	Type
UFH-RAS10	25.2 m ² (10 x 2,52 m ²)	2,52 m ² - grid 100x100mm
UFH-RAS15	25.2 m ² (10 x 2,52 m ²)	2,52 m ² - grid 150x150mm
UFH-RAS20	24 m ² (10 x 2,4 m ²)	2,4 m ² - grid 200x200mm

Type: UFH-RAS-RB3



Connection clip for steel mesh
Verbindingsclip voor stalen draadmatten
Clip de fixation pour treillis
Verbinder für Trägermatte

Article number	Bag / Box	Type
UFH-RAS-RB3	30 pc. / 3.000 pc.	RB



Henco Underfloor Heating

Underfloor Heating Systems

1 Type: UFH-RAS-BIND15



UFH-RAS-VLE p 156

Steel strand, plasticized, to connect pipe on steel mesh
 Stalen vlechtdraad, geplastificeerd, om buis op draadmat te binden
 Fil de tressage métallique, plastifié, pour fixer tube sur treillis
 Stahldraht, plastifiziert, für Befestigung der Rohre auf Trägermatte

Article number	Bag	Type
UFH-RAS-BIND15A	250 pc.	160 mm
UFH-RAS-BIND15B	2500 pc.	160 mm

2 Type: UFH-RAS-CLIP



Synthetic clip for steel mesh
 Kunststofclip voor draadmat
 Attache en plastique pour treillis
 Rohrclip für Trägermatte

Article number	Bag / Box	Type
UFH-RAS-CLIP16	200 pc. / 1000 pc	Ø16
UFH-RAS-CLIP18	200 pc. / 1000 pc	Ø18
UFH-RAS-CLIP20*	200 pc. / 1000 pc	Ø20

**TILL EXHAUSTION OF STOCK*

3 Type: UFH-TACK-KLS



Tacker sheet with EPS insulation, foil with 100 x 100 mm grid marking and overlap
 Tacker klapset met EPS isolatie voorzien van folie met raster 100 x 100 mm en overlap
 Plaque tacker en isolation EPS, film avec trame 100 x 100 mm et rabat
 Verbundplatte aus Styropordämmung mit Folie Masche 100 x 100 mm und Überschneidung

Article number	Multipack	Type
UFH-TACK-KLS20	10 m2 (5 x 2m ²)	1000x2000x20mm - 4kPa - 28dB R 0,44
UFH-TACK-KLS25	10 m2 (5 x 2m ²)	1000x2000x25mm - 4kPa - 28dB R 0,56
UFH-TACK-KLS30	10 m2 (5 x 2m ²)	1000x2000x30mm - 4kPa - 29dB R 0,67
UFH-TACK-KLS40	10 m2 (5 x 2m ²)	1000x2000x40mm - 4kPa - 30dB R 0,89

4 Type: UFH-TACK-38K



UFH-TACK p 157

Tacker clip, 38 mm
 Tackernagel, 38 mm
 Agrafe tacker, 38 mm
 Tackernadel, 38 mm

Article number	Box / Big Box	Type
UFH-TACK-38K	300 pc. / 6000 pc.	38mm

TILL EXHAUSTION OF STOCK

5 Type: UFH-TACK-40



UFH-TACK p 157

Tacker clip, 40 mm
 Tackernagel, 40 mm
 Agrafe tacker, 40 mm
 Tackernadel, 40 mm

Article number	Box / Big Box	Type
UFH-TACK-40*	300 pc. / 8400 pc.	40mm

**Pipe Ø 16 -20*

6 Type: UFH-TACK-60



UFH-TACK p 157

Tacker clip, 60 mm
 Tackernagel, 60 mm
 Agrafe tacker, 60 mm
 Tackernadel, 60 mm

Article number	Box / Big Box	Type
UFH-TACK-60	300 pc. / 6000 pc.	60mm



Type: UFH-SCOTCH-66



Adhesive tape
Kleefband
Ruban adhésif
Klebeband

Article number	Bag / Box	Type
UFH-SCOTCH-66	1 pc. / 48 pc.	66 m

Type: UFH-DRY-F



Secor EPS panel with milling and alu foil
Secor EPS paneel met frezing en aluminium toplaag
Panneau Secor en insulation PE avec fraisage et film en alu
Secor platte aus Styropordämmung mit Fräsung und ALU folie

Article number	Pallet	Type
UFH-DRY-1617-150F	8.8 m2	1177x750x17 - 150mm - 300 kPa - 0,27m ² K/W
UFH-DRY-1617-200F	9 m2	1177x800x 7 - 200mm - 300 kPa - 0,24m ² K/W
UFH-DRY-1625-100F	9.4 m2	1177x800x25 - 100mm - 300 kPa - 0,53m ² K/W
UFH-DRY-1625-150F	8.8 m2	1177x750x25 - 150mm - 300 kPa - 0,60m ² K/W
UFH-DRY-1625-200F	9 m2	1177x 800x25 - 200mm - 300 kPa - 0,61m ² K/W
UFH-DRY-1630-150F	9.4 m2	1177x750x30 - 150mm - 300 kPa - 0,75m ² K/W

Type: UFH-DRY-FTAPE



SECOR Alu tape 50mmx25m
SECOR Alu kleefband 50mmx25m
SECOR Bande adhésive aluminium 50mmx25m
SECOR ALU Klebeband 50mmx25m

Article number	Bag / Box	Type
UFH-DRY-FTAPE	1 pc. / 36 pc.	25m x 50mm

Type: UFH-DRY-GLUEF



Secor glue
Secor lijm
Colle secor
Secor Klebstoff

Article number	Box	Type
UFH-DRY-GLUEF	15 pc.	1 KG

Type: UFH-P18-GP18



Gypsum fibreboard 18mm, round milling for RENO12 system
Gipsvezelplaat 18mm, ronde frezing voor RENO12 systeem
Plaques en fibro-plâtre 18mm, avec une fraisage circulaire système RENO12
Gipsfaserplatte 18mm, runde Fräsung für das RENO12 system

Article number	Multipack	Type
UFH-P18-GP18	1 pc.	1000 x 600 x 18mm



Henco Underfloor Heating

Underfloor Heating Systems

Type: UFH-P18-GP18V



Gypsum fibreboard 18mm, vertical milling for RENO12 system
 Gipsvezelplaat 18mm, verticale frezing voor RENO12 systeem
 Plaques en fibro-plâtre 18mm, système RENO12
 Gipsfaserplatte 18mm, vertikale Fräsung für das RENO12 system

Article number	Multipack	Type
UFH-P18-GP18V	1 pc.	1000 x 600 x 18mm

Type: UFH-P18-GP10



Gypsum fibreboard 10mm, flat for RENO12 system
 Gipsvezelplaat 10mm, Vlak Voor Reno12 Systeem
 Plaques en fibro-plâtre 10mm, système RENO12
 Gipsfaserplatte 10mm, flach für das RENO12 system

Article number	Multipack	Type
UFH-P18-GP10	1 pc.	1500 x 1000 x 10mm

Type: UFH-P18-WN



Mesh for RENO12 system
 Wapeningsnet voor RENO12 systeem
 Treillis d'armature pour le système reno12
 Betonstahlmatte für das RENO12 system

Article number	Coil	Type
UFH-P18-WN*	1 m	1 x 50m

**TILL EXHAUSTION OF STOCK*

Type: UFH-ISODRY-25



Insulation system board for dry system
 Isolatieplaat voor droog systeem
 Panneau d'isolation pour système sec
 Systemplatte für Trockenbau

Article number	Multipack	Type
UFH-ISODRY-25	10 m2	1000x500x25mm

Type: UFH-DRY-GP100/2



Heat diffusion profile for dry system
 Stralingsprofiel voor droog systeem
 Profil de diffusion pour système sec
 Wärmeleitlamelle für Trockenbau

Article number	Box	Type
UFH-DRY-GP100/2	50 pc.	997x120x0,4mm - Ø16

Type: UFH-UP-M



Clip rail with adhesive strip, centres 50 mm
 U-profiel met kleefband, verlegafstand 50 mm
 Profil-U avec bande adhésif, distance de pose 50 mm
 Kunststoffclip-Schiene klebfertig für Rohr, Verlegung 50 mm

Article number	Box	Type
UFH-UP-14M1	100 pc.	Ø14 - AS 25 mm- 1000 mm
UFH-UP-16M1	100 pc.	Ø16 - AS 50 mm- 1000 mm



Type: UFH-UP



Clip rail with adhesive strip, centres 50 mm
 U-profiel met kleefband, verlegafstand 50 mm
 Profil-U avec bande adhésif, distance de pose 50 mm
 Kunststoffclip-Schiene klebfertig für Rohr, Verlegung 50 mm

Article number	Box / Pallet	Type
UFH-UP-12	40 m / 1200 m	Ø12 - AS 25 mm- 2000 mm
UFH-UP-16	100 m / 3000 m	Ø16 - AS 50 mm- 2500 mm

Type: UFH-UP-CUP



Staple for clip rail
 Clip voor U-profielen
 Agrafe pour profil-U
 Nadel für Schienen

Article number	Box	Type
UFH-UP-CUP50	500 pc.	50 mm

Type: UFH-FOIL



PE film, transparant, with blue grid marking 50 x 50 mm
 PE-folie, transparant, blauwe rastermarkering 50 x 50 mm
 Film en PE, transparent avec marquage 50 x 50 mm en bleu
 Polyethylen-Schutzfolie,transparent,Markierung Blau 50x50mm

Article number	Roll	Type
UFH-FOIL50	51 m ²	50X50mm 50m ²
UFH-FOIL90	90 m ²	50X50m 90m ²

Type: UFH-FOIL-N



Pe film,neutral
 Pe-Folie,Neutraal
 Film en pe ,neutre
 Polyethylen-schutzfolie,neutral

Article number	Roll	Type
UFH-FOIL-N	100 m ²	50 m x 2 m - 0,2 mm

Type: UFH-FOIL-ALU



PE film, reflecting ALU
 PE-folie, met PE-flap en ALU reflectie
 Film en PE avec réflexion ALU
 Polyethylen-Schutzfolie, Refltion ALU

Article number	Roll	Type
UFH-FOIL-ALU	50 m ²	50 m x 1 m - 3,0 mm

Type: UFH-FOIL-CLIP25



Clip for Film
 Dampfolienagel
 Agrafe pour film PE
 Foliendübel

Article number	Bag	Type
UFH-FOIL-CLIP25	100 pc.	25mm

1

2

3

4

5

6

7

8

9

10

11

12



Henco Underfloor Heating

Underfloor Heating Systems

Type: UFH-PLUG80



Plug, shaft length 80 mm, Ø8 mm
Montageplug, schachtlengte 80 mm, Ø8 mm
Cheville de montage, longueur 80 mm, Ø8 mm
Niederhaltedübel, Bohrer Ø 8 mm, Schaftlänge 80 mm

Article number	Bag / Box	Type
UFH-PLUG80	100 pc. / 1000 pc.	80 mm, Ø8 mm

Type: UFH-ISOBOARD-S



PE edge isolation with lapping strip and adhesive strip
Randisolatie uit PE-schuim met flap en kleefstroken
Isolation périphérique en PE avec rabat et bande adhésif
Randdämmstreifen aus PE mit Abrisskante und Klebestreifen

Article number	Roll	Type
UFH-ISOBOARD-S	25 m	150 x 8 mm

Type: UFH-ISOBOARD-GVNL



PE edge isolation with lapping strip and adhesive strip for liquid floors
Randisolatie voor gietvloeren uit PE-schuim met flap en kleefstroken
Isolation périphérique en PE avec rabat et bande adhésif pour sols coulés
Randdämmstreifen aus PE mit Abrisskante und Klebestreifen für Gussböden

Article number	Roll	Type
UFH-ISOBOARD-GVNL	50 m	100 mm x 8 mm

Type: UFH-ISOBOARD-GV



PE edge isolation with lapping strip and adhesive strip for anhydrite screed
Randiso. voor anhydriet chape uit PE-schuim met flap en kleefstroken
Isolation périphérique en PE avec rabat et bande adhésif, pour chape anhydrite
Randdämmstreifen aus PE mit Abrisskante und Klebestreifen, für Anhydritestrich

Article number	Roll	Type
UFH-ISOBOARD-GV	25 m	150 mm x 8 mm

Type: UFH-DP200



PE expansion joint with self-adhesive rail
Uitzettingsvoeg uit PE-schuim met zelfklevende rail
Joint de dilatation en PE avec bande adhésive
Dehnungsfuge aus PE mit Klebestreifen

Article number	Pack / Box	Type
UFH-DP200	10 pc. / 50 pc.	2000 mm x 100 mm x 8 mm



Type: UFH-DH40



Protection sleeve for expansion joint
 Voegdoorganghuls
 Gaine de protection pour joint de dilatation
 Schutzrohre für Dehnungsfugen

Article number	Box	Type
UFH-DH40	100 pc.	400 mm

Type: UFH-BEND



Bend guide for pipe
 Geleidingsbocht voor buis
 Courbe pour tube
 Rohrführungsbogen

Article number	Bag / Box	Type
UFH-BEND1218	50 pc. / 400 pc.	Ø 12 - 18 mm
UFH-BEND20	50 pc. / 100 pc.	Ø 20 mm

Type: UFH-ADN10



Additive for screed (min. pipe covering 45 mm)
 Toevoegmiddel voor zandcementdekvloer (min. buisoverdekking 45 mm)
 Additif pour chape de ciment (min. épaisseur de chape au-dessus du tube 45 mm)
 Estrichzusatz (min. Rohrüberdeckung 45 mm)

Article number	Drum	Type
UFH-ADN10	10 L	

- 1
- 2
- 3
- 4
- 5
- 6
- 7
- 8
- 9
- 10
- 11
- 12



Henco Underfloor Heating

District Heating Manifolds

Type: UFH-CDP



Composite manifold, adjustable with flow meter and A-pump
 Composiet verdeler, regelbaar met debietmeting en A-pomp
 Collecteur composite, réglable avec débitmètre et pompe label A
 Verteiler Composite, regelbar mit Durchflussummengenähler und A-Pumpe

Article number	Box	Type
UFH-0405CDP01	1 pc.	1/2" - 1 x 3/4"
UFH-0405CDP02	1 pc.	1/2" - 2 x 3/4"
UFH-0405CDP03	1 pc.	1/2" - 3 x 3/4"
UFH-0405CDP04	1 pc.	1/2" - 4 x 3/4"
UFH-0405CDP05	1 pc.	1/2" - 5 x 3/4"
UFH-0405CDP06	1 pc.	1/2" - 6 x 3/4"
UFH-0505CDP07	1 pc.	3/4" - 7 x 3/4"
UFH-0505CDP08	1 pc.	3/4" - 8 x 3/4"
UFH-0505CDP09	1 pc.	3/4" - 9 x 3/4"
UFH-0505CDP10	1 pc.	3/4" - 10 x 3/4"
UFH-0505CDP11	1 pc.	3/4" - 11 x 3/4"
UFH-0505CDP12	1 pc.	3/4" - 12 x 3/4"
UFH-0505CDP13	1 pc.	3/4" - 13 x 3/4"
UFH-0505CDP14	1 pc.	3/4" - 14 x 3/4"
UFH-0505CDP15	1 pc.	3/4" - 15 x 3/4"
UFH-0505CDP16	1 pc.	3/4" - 16 x 3/4"

Type: UFH-CD



Composite manifold, adjustable with flow meter
 Composiet verdeler, regelbaar met debietmeting
 Collecteur composite, réglable avec débitmètre
 Verteiler Composite, regelbar mit Durchflussummengenähler

Article number	Box	Type
UFH-0605CD01	1 pc.	1" - 1 x 3/4"
UFH-0605CD02	1 pc.	1" - 2 x 3/4"
UFH-0605CD03	1 pc.	1" - 3 x 3/4"
UFH-0605CD04	1 pc.	1" - 4 x 3/4"
UFH-0605CD05	1 pc.	1" - 5 x 3/4"
UFH-0605CD06	1 pc.	1" - 6 x 3/4"
UFH-0605CD07	1 pc.	1" - 7 x 3/4"
UFH-0605CD08	1 pc.	1" - 8 x 3/4"
UFH-0605CD09	1 pc.	1" - 9 x 3/4"
UFH-0605CD10	1 pc.	1" - 10 x 3/4"
UFH-0605CD11	1 pc.	1" - 11 x 3/4"
UFH-0605CD12	1 pc.	1" - 12 x 3/4"
UFH-0605CD13	1 pc.	1" - 13 x 3/4"
UFH-0605CD14	1 pc.	1" - 14 x 3/4"
UFH-0605CD15	1 pc.	1" - 15 x 3/4"
UFH-0605CD16	1 pc.	1" - 16 x 3/4"
UFH-0605CD17	1 pc.	1" - 17 x 3/4"
UFH-0605CD18	1 pc.	1" - 18 x 3/4"
UFH-0605CD19	1 pc.	1" - 19 x 3/4"
UFH-0605CD20	1 pc.	1" - 20 x 3/4"

Type: UFH-CP



A-pump unit for composite collector
 Pompunit composiet verdeler, met A-pomp
 Kit pompe-A pour collecteur composite
 A-Pump Unit für Composite Verteiler

Article number	Box	Type
UFH-CP	1 pc.	1"



Type: UFH-SLT



Including cord, plug and maximum thermostat.

Steel collector with A-pump

Stalen verdeler met A-pomp en LTV inregelventiel

Stalen verdeler met A-pomp en LTV inregelventiel

Stalen verdeler met A-pomp en LTV inregelventiel

Article number	Box	Type
UFH-0405SLT01	1 pc.	1/2" - 1 x 3/4"
UFH-0405SLT02	1 pc.	1/2" - 2 x 3/4"
UFH-0405SLT03	1 pc.	1/2" - 3 x 3/4"
UFH-0405SLT04	1 pc.	1/2" - 4 x 3/4"
UFH-0405SLT05	1 pc.	1/2" - 5 x 3/4"
UFH-0405SLT06	1 pc.	1/2" - 6 x 3/4"
UFH-0505SLT07	1 pc.	3/4" - 7 x 3/4"
UFH-0505SLT08	1 pc.	3/4" - 8 x 3/4"
UFH-0505SLT09	1 pc.	3/4" - 9 x 3/4"
UFH-0505SLT10	1 pc.	3/4" - 10 x 3/4"
UFH-0505SLT11	1 pc.	3/4" - 11 x 3/4"
UFH-0505SLT12	1 pc.	3/4" - 12 x 3/4"
UFH-0505SLT14	1 pc.	3/4" - 14 x 3/4"
UFH-0505SLT15	1 pc.	3/4" - 15 x 3/4"
UFH-0505SLT16	1 pc.	3/4" - 16 x 3/4"

Type: UFH-SSTE



Including cord, plug and maximum thermostat.

Steel collector with pump, district heating Essent

Stalen verdeler met pomp, stadsverwarming Essent

Collecteur en acier avec pompe, chauffage urbain Essent

Verteiler Stahl mit Pump, Fernheizung Essent

Article number	Box	Type
UFH-0405SSTE02-PN6	1 pc.	1/2" - 2 x 3/4"
UFH-0405SSTE03-PN6	1 pc.	1/2" - 3 x 3/4"
UFH-0405SSTE04-PN6	1 pc.	1/2" - 4 x 3/4"
UFH-0405SSTE06-PN6	1 pc.	1/2" - 6 x 3/4"
UFH-0505SSTE07-PN6	1 pc.	3/4" - 7 x 3/4"
UFH-0505SSTE08-PN6	1 pc.	3/4" - 8 x 3/4"
UFH-0505SSTE09-PN6	1 pc.	3/4" - 9 x 3/4"
UFH-0505SSTE10-PN6	1 pc.	3/4" - 10 x 3/4"
UFH-0505SSTE11-PN6	1 pc.	3/4" - 11 x 3/4"
UFH-0505SSTE12-PN6	1 pc.	3/4" - 12 x 3/4"



Henco Underfloor Heating

Underfloor Heating Synthetic Manifolds

Type: UFH-MDK



Composite manifold, adjustable with flow meter, washer and air vent

Composiet verdeler, regelbaar met debietmeting, therm, vul-aftapkraan, ontluchter

Collecteur composite, réglable avec débitmètre, thermomètre, vanne d'apport et purgeur d'air

Verteiler Composite, regelbar mit Durchflussumengenzahl, therm, Entleerung-Entluft.

Article number	Box	Type
UFH-0605MDK02-03L	1 pc.	1" - 2 x 3/4"
UFH-0605MDK03-03L	1 pc.	1" - 3 x 3/4"
UFH-0605MDK04-03L	1 pc.	1" - 4 x 3/4"
UFH-0605MDK05-03L	1 pc.	1" - 5 x 3/4"
UFH-0605MDK06-03L	1 pc.	1" - 6 x 3/4"
UFH-0605MDK07-03L	1 pc.	1" - 7 x 3/4"
UFH-0605MDK08-03L	1 pc.	1" - 8 x 3/4"
UFH-0605MDK09-03L	1 pc.	1" - 9 x 3/4"
UFH-0605MDK10-03L	1 pc.	1" - 10 x 3/4"
UFH-0605MDK11-03L	1 pc.	1" - 11 x 3/4"
UFH-0605MDK12-03L	1 pc.	1" - 12 x 3/4"

NEW*
PRODUCT

Type: UFH-MDK-PRM



Pre-mounted composite manifold, adjustable with flow meter, washer and air vent

Voorgemonteerde composiet verdeler, regelbaar met debietmeting, therm, vul-aftapkraan, ontluchter

Collecteur composite pré-assemblé, réglable avec débitmètre, thermomètre, vanne d'apport et purgeur d'air

Vormontierter verteiler Composite, regelbar mit Durchflussumengenzahl, therm, Entleerung-Entluft.

Article number	Box	Type
UFH-0605MDK02-03LPRM	1 pc.	1" - 2 x 3/4"
UFH-0605MDK03-03LPRM	1 pc.	1" - 3 x 3/4"
UFH-0605MDK04-03LPRM	1 pc.	1" - 4 x 3/4"
UFH-0605MDK05-03LPRM	1 pc.	1" - 5 x 3/4"
UFH-0605MDK06-03LPRM	1 pc.	1" - 6 x 3/4"
UFH-0605MDK07-03LPRM	1 pc.	1" - 7 x 3/4"
UFH-0605MDK08-03LPRM	1 pc.	1" - 8 x 3/4"
UFH-0605MDK09-03LPRM	1 pc.	1" - 9 x 3/4"
UFH-0605MDK10-03LPRM	1 pc.	1" - 10 x 3/4"
UFH-0605MDK11-03LPRM	1 pc.	1" - 11 x 3/4"
UFH-0605MDK12-03LPRM	1 pc.	1" - 12 x 3/4"



Type: UFH-MDSS



Stainless steel manifold
Roestvrij stalen verdeler
Collecteur en acier inoxydable
Edelstahlverteiler

Article number	Box	Type
UFH-0605MDSS02	1 pc.	1" -2X3/4
UFH-0605MDSS03	1 pc.	1" -3X3/4
UFH-0605MDSS04	1 pc.	1" -4X3/4
UFH-0605MDSS05	1 pc.	1" -5X3/4
UFH-0605MDSS06	1 pc.	1" -6X3/4
UFH-0605MDSS07	1 pc.	1" -7X3/4
UFH-0605MDSS08	1 pc.	1" -8X3/4
UFH-0605MDSS09	1 pc.	1" -9X3/4
UFH-0605MDSS10	1 pc.	1" -10X3/4
UFH-0605MDSS11	1 pc.	1" -11X3/4
UFH-0605MDSS12	1 pc.	1" -12X3/4
UFH-0605MDSS13	1 pc.	1" -13X3/4
UFH-0605MDSS14	1 pc.	1" -14X3/4
UFH-0605MDSS15	1 pc.	1" -15X3/4

1

2

3

4

5

6

7

8

9

10

11

12



Henco Underfloor Heating

Underfloor Heating Manifolds

Type: UFH-MDK-CON



Composite connector for MDK Manifold
 Composiet verbinder voor MDK Verdeler
 Connecteur en composite pour collecteur MDK
 Composite connector for MDK Manifold

Article number	Bag / Box	Type
UFH-MDK-CON	1 pc. / 50 pc.	

Type: UFH-MDK-AO



Automatic air vent in composite for MDK manifold
 Automatische ontluchter composiet voor MDK verdeler
 Purgeur automatique en composite pour collecteur MDK
 Automatische entlüftung in composiet für MDK verteiler

Article number	Bag	Type
UFH-MDK-AO	1 pc.	3/8"

Type: UFH-CMDK



Flow meter for MDK manifold
 Debietmeter voor MDK verdeler
 Débitmètre pour collecteur MDK
 Durchflussmengenanzeiger für MDK Verteiler

Article number	Bag	Type
UFH-CMDK03	1 pc.	0 - 3 l/min

Type: UFH-06-MD



Manifold brass, adjustable, with flow meters
 Verdeler messing, regelbaar, met debietmeting
 Collecteur en laiton, réglable, avec débitmètres
 Verteiler aus Messing, regelbar, mit Durchflüssenmengenanzähler

Article number	Box	Type
UFH-060502-MD	1 pc.	1" - 2X3/4
UFH-060503-MD	1 pc.	1 -3X3/4
UFH-060504-MD	1 pc.	1 -4X3/4
UFH-060505-MD	1 pc.	1 -5X3/4
UFH-060506-MD	1 pc.	1 -6X3/4
UFH-060507-MD	1 pc.	1 -7X3/4
UFH-060508-MD	1 pc.	1 -8X3/4
UFH-060509-MD	1 pc.	1 -9X3/4
UFH-060510-MD	1 pc.	1 -10X3/4
UFH-060511-MD	1 pc.	1 -11X3/4
UFH-060512-MD	1 pc.	1 -12X3/4

Type: UFH-M-D



Flow meter for brass manifold
 Debietmeter voor messing verdeler
 Débitmètre pour collecteur en laiton
 Durchflussmengenanzeiger für Verteiler aus Messing

Article number	Box	Type
UFH-M-D	1 pc.	0-6 l/min



Type: UFH-CMDSS



Flow meter for MDSS manifold
Debietmeter voor MDSS verdeler
Débitmètre pour collecteur MDSS
Durchflussmengenanzeiger für MDSS Verteiler

Article number	Bag	Type
UFH-CMDSS03	1 pc.	0 - 5 l/min

Type: UFH-PGKTA



Pump unit A label pump with consistent temperature control
Pompgroep A-label met regeling voor constante temperatuur
Kit pompe label A avec régulation de température constante
Konstanttemperaturregelung mit A-Pumpe

Article number	Box	Type
UFH-PGKTA	1 pc.	1°F / 27°C - 42°C

Use the N06 nipple 1" x 1" to connect the pump unit to the underfloor heating manifold

Type: N



Nipple 1"x1" to connect UFH-PGKTA to manifold
Nippel 1"x1" om UFH-PGKTA aan te sluiten op verdeler
Nipple 1"x1" pour connecter UFH-PGKTA au collecteur
Nippel 1 "x1" zum Anschluss von UFH-PGKTA an Verteiler

Article number	Bag / Box	Type
N06	25 pc. / 250 pc.	1"x1"

Type: UFH-PGKTA-TH



Thermostatic sensor
Thermostaat kop
Tête thermostatique
Thermostatkopf

Article number	Box	Type
UFH-PGKTA-TH	1 pc.	

Type: UFH-GKT



Unit with consistent temperature control without pump
Groep met regeling voor constante temperatuur zonder pomp
Kit avec régulation de température constante sans pompe
Konstanttemperaturregelung ohne Pump

Article number	Box	Type
UFH-GKT	1 pc.	1°F / 27°C - 42°C

Type: UFH-BT



1" ball valve with 1" swivel nut, washer and thermometer
Kogelkraan 1" met wartelmoer 1", dichting en thermometer
Vanne à sphère 1" avec écrou 1", joint et thermomètre
Kugelhahnset 1"IG mit Mutter 1"IG, Dichtung und Thermometer

Article number	Bag / Box	Type
UFH-BTM0606-M	1 pc. / 20 pc.	1°F x 1°F / 0 - 60 °



Henco Underfloor Heating

Underfloor Heating Manifolds

Type: UFH-B



1" F ball valve with 1" F swivel nut and washer
Kogelkraan 1" F met wartelmoer 1" F en dichting
Vanne à sphère 1" F avec écrou 1" F et joint plat
Kugelhahnset 1" IG mit Mutter 1" IG und Dichtung

Article number	Bag / Box	Type
UFH-B0606-M	1 pc. / 25 pc.	1" F x 1" F

Type: UFH-ESK



1" F end cap with nut, washer, ball valve and air vent 3/8"
Eindstuk 1" F met moer, dichting, kogelkraan en ontluftingskraan 3/8"
Bouchon terminal 1" F avec écrou, vanne à sphère, joint et purgeur 3/8"
Verteilerendstückset 1" IG mit Mutter und Dichtung, Entlüftung 3/8", Kugelhahnset

Article number	Bag / Box	Type
UFH-ESK060303-M	1 pc. / 25 pc.	1" F x 1/2" x 3/8"

Type: UFH-ESK-VN



1" F end cap with nut, washer, ball valve and air vent 3/8", nickel-plated
Eindstuk 1" F met moer, dichting, kogelkraan en ontluftingskraan 3/8", vernikkeld
Bouchon terminal 1" F avec écrou, joint et purgeur 3/8", nickelé
Verteilerendstückset 1" IG mit Mutter und Dichtung, Entlüftung 3/8", Kugelhahnset, vernikkelt Article num

Article number	Bag / Box	Type
UFH-ESK060303-VN*	2 pc. / 20 pc.	1" F x 1/2" x 3/8"

**TILL EXHAUSTION OF STOCK*

Type: UFH-AO-MZ



Automatic air vent, without check valve
Automatische ontlufter, zonder waterslot
Purgeur automatique, sans serrure d'eau
Schnellentlüfter mit vertikaler Entlüftung, ohne Wasserabsperung

Article number	Bag / Box	Type
UFH-AO03-MZ	1 pc. / 50 pc.	3/8"

Type: UFH-TM-M



Thermometer for return with EK connections
Thermometer voor terugvoer met euroconus aansluitingen
Retour thermomètre avec raccordement eurocone
Thermometer zum Anschluss Rucklauf mit Eurokonus-Anschlüssen

Article number	Bag / Box	Type
UFH-TM050-M	1 pc. / 72 pc.	3/4" - 3/4" EK / 0 - 50°C

Type: UFH-BS-M



End cap with washer
Blindstop
Bouchon
Kappe mit Dichtung

Article number	Bag / Box	Type
UFH-BS05-M	1 pc. / 50 pc.	3/4"



Type: UFH-C260003001



Thermostatic temperature limiter 3/4"xEK
 Thermostatische temperatuurbegrenzer 3/4"xEK
 Limiteur de température thermostatique 3/4"xEK
 Thermostatischer Temperaturbegrenzer 3/4"xEK

Article number	Bag / Box	Type
UFH-C260003001	1 pc. / 50 pc.	3/4"

Type: UFH-B-VN



1" F ball valve with 1" F swivel nut and washer , nickel-plated
 Kogelkraan 1" F met wartelmoer 1" F en dichting, vernikkeld
 Vanne à sphère 1" F avec écrou 1" F et joint, nickelé
 Kugelhahnset 1" IG mit Mutter 1" IG und Dichtung, vernickelt

Article number	Bag / Box	Type
UFH-B0606-VN	1 set (2 pc.) / 10 sets	1" F x 1" F / 0 - 60°

**TILL EXHAUSTION OF STOCK*

Type: UFH-BMH-VN



Ball valve 90° with gasket, nickel plated (MDK and MDSS manifold), no thermometer
 Kogelkraan 90° met dichting, vernikkeld (MDK en MDSS verdeler), geen thermometer
 Vanne à sphère 90° et joint, nickelé (collecteur MDK et MDSS), sans thermomètre
 Kugelhahnset 90°, vernickelt (Verteiler MDK und MDSS), ohne thermomètre

Article number	Box / Big Box	Type
UFH-BMH0606-VN	1 set (2 pc.) / 10 sets	1"x1"

Type: UFH-BMHT-VN



Ball valve 90° with gasket, nickel plated (MDK and MDSS manifold), thermometer
 Kogelkraan 90° met dichting, vernikkeld (MDK en MDSS verdeler), met thermometer
 Vanne à sphère 90° et joint, nickelé (collecteur MDK et MDSS), avec thermomètre
 Kugelhahnset 90°, vernickelt (für Verteiler MDK und MDSS), mit thermomètre

Article number	Box / Big Box	Type
UFH-BMH0606T-VN	1 set (2 pc.) / 12 sets	1"x1"

Type: UFH-BM-VN



Ball valve with gasket, nickel plated (for MDK and MDSS manifold)
 Kogelkraan met dichting, vernikkeld (voor MDK en MDSS verdeler)
 Vanne à sphère et joint, nickelé (pour collecteur MDK et MDSS)
 Kugelhahnset, vernickelt (für Verteiler MDK und MDSS)

Article number	Box / Big Box	Type
UFH-B0605-VN*	1 set (2 pc.) / 15 sets	3/4" x 1"
UFH-BM0606-VN	1 set (2 pc.) / 10 sets	1"x1"

**TILL EXHAUSTION OF STOCK*



Henco Underfloor Heating

Underfloor Heating Manifolds

Type: UFH-C192071



Safety thermostat incl. wire/plug
Maximaalthermostaat, incl. snoer/stekker
Thermostat de sécurité, incl. fil/prise
Maximal Thermostat incl. Snur/Stecker

Article number	Bag	Type
UFH-C192071	1 pc.	

Type: UFH-C191800



Thermometer with immersion sleeve 0/60°C
Thermometer with immersion sleeve 0/60°C
Thermomètre temp. 0/60°C avec bulbe
Thermometer mit Tauchhülse 0/60°C

Article number	Bag	Type
UFH-C191800	1 pc.	

Type: UFH-C191974



Circulator Wilo Yonos Para RS 15/6-RKA KU 130mm (excl. wire/plug)
Circulator Wilo Yonos Para RS 15/6-RKA KU 130mm (excl. snoer/stekker)
Circulateur Wilo Yonos Para RS 15/6-RKA KU 130mm (excl. fil/prise)
Cirkulator Wilo Yonos Para RS 15/6-RKA KU 130mm (excl. Snur/Stecker)

Article number	Bag	Type
UFH-C191974	1 pc.	1"

Type: UFH-C191976



Circulator Wilo Yonos Para RS 25/6-RKA KU 130mm (excl. wire/plug)
Circulator Wilo Yonos Para RS 25/6-RKA KU 130mm (excl. snoer/stekker)
Circulateur Wilo Yonos Para RS 25/6-RKA KU 130mm (excl. fil/prise)
Cirkulator Wilo Yonos Para RS 25/6-RKA KU 130mm (excl. Snur/Stecker)

Article number	Bag	Type
UFH-C191976	1 pc.	1 1/2"



Wired control unit
Bekabelde zoneregeling
Régulateurs de zone cablés
Regelverteiler verdrahtet

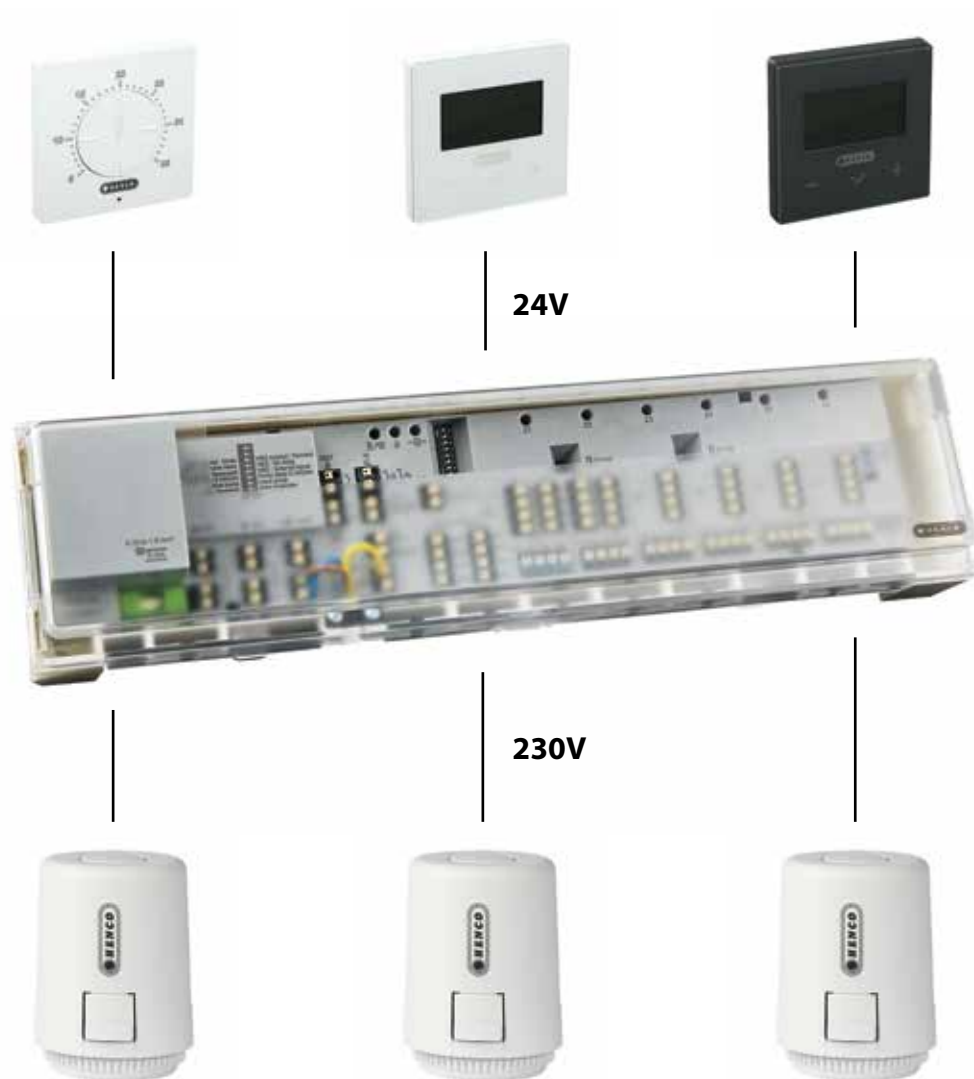

- 1
- 2
- 3
- 4
- 5
- 6
- 7
- 8**
- 9
- 10
- 11
- 12



Henco Underfloor Heating

HencoLogic Wired

NEW*
PRODUCT

Type: CU-6ZONEB-H



Base module 6 zones heating, wired
Basisstation 6 zones verwarmen, bekabeld
Base module 6 zones chauffer, câble
Regelkleimleiste 6-zonen Heizen, Verdrahtet

Article number	Box / Big Box	Type
CU-6ZONEB-H	1 pc. / 6 pc.	

Type: CU-6ZONEB-HC

NEW*
PRODUCT



Base module 6 zones heating/cooling, wired
Basisstation 6 zones verwarmen/koelen, bekabeld
Base module 6 zones chauffer/refroidir, câble
Regelkleimleiste 6-zonen Heizen/Kuhlen, Verdrahtet

Article number	Box / Big Box	Type
CU-6ZONEB-HC	1 pc. / 6 pc.	

Type: CU-6ZONE-CON

NEW*
PRODUCT



Extension module 6 zones, wired
Uitbreidingsmodule 6 zone, bekabeld
Module d'extension 6 zones, câble
Erweiterungsmodul 6-zonen Heizen/Kuhlen, Verdrahtet

Article number	Box / Big Box	Type
CU-6ZONE-CON	1 pc. / 6 pc.	

Type: CU-ATHERMB-H

NEW*
PRODUCT



Analog thermostat heating, wired
Analoge thermostaat verwarmen, bekabeld
Thermostat analogue chauffer, câble
Analog Raumthermostat Heizen, Verdrahtet

Article number	Box / Big Box	Type
CU-ATHERMB-H	1 pc. / 84 pc.	

Type: CU-ATHERMB-HC

NEW*
PRODUCT



Analog thermostat heating/cooling, wired
Analoge thermostaat verwarmen/koelen, bekabeld
Thermostat analogue chauffer/refroidir, câble
Analog Raumthermostat Heizen/Kuhlen, Verdrahtet

Article number	Box / Big Box	Type
CU-ATHERMB-HC	1 pc. / 84 pc.	



Type: CU-DTHERMB-HC

NEW*
PRODUCT



Digital thermostat heating/cooling, wired
 Digitale thermostaat verwarmen/koelen, bekabeld
 Thermostat digitale chauffeur/refroidir, câble
 LCD Raumthermostat Heizen/Kuhlen, Verdrahtet

Article number	Box / Big Box	Type
CU-DTHERMB-HC	1 pc. / 84 pc.	White

Type: CU-DTHERMB-HC-B

NEW*
PRODUCT



Digital thermostat heating/cooling, wired, black
 Digitale thermostaat verwarmen/koelen, bekabeld, zwart
 Thermostat digitale chauffeur/refroidir, câble, noir
 LCD Raumthermostat Heizen/Kuhlen, Verdrahtet, Schwarz

Article number	Box / Big Box	Type
CU-DTHERMB-HC-B	1 pc. / 84 pc.	Black

Type: CU-ACT-B230V

NEW*
PRODUCT



Actuator with cable 1m
 Actuator met vaste kabel 1m
 Electrovanne avec cable 1m
 Stellantrieb Kabel 1m

Article number	Box / Big Box	Type
CU-ACT-B230V	1 pc. / 100 pc.	230V

Type: UFH-ANC



Valve
 Zoneventiel
 Vanne
 Ventil

Article number	Box	Type
UFH-ANC05	1 pc.	2 x 3/4" - M30x1,5 - Kv 2
UFH-ANC06	1 pc.	2 x 1" - M30x1,5 - Kv 4,5

- 1
- 2
- 3
- 4
- 5
- 6
- 7
- 8
- 9
- 10
- 11
- 12



Henco Underfloor Heating

HencoLogic Wireless

Wireless control unit (Heating/cooling)
Draadloze zoneregeling (Verwarmen/koelen)
Régulateurs de zone sans fil (Chauffage/refroidissement)
Regelverteiler funk (Heizen/kühlen)

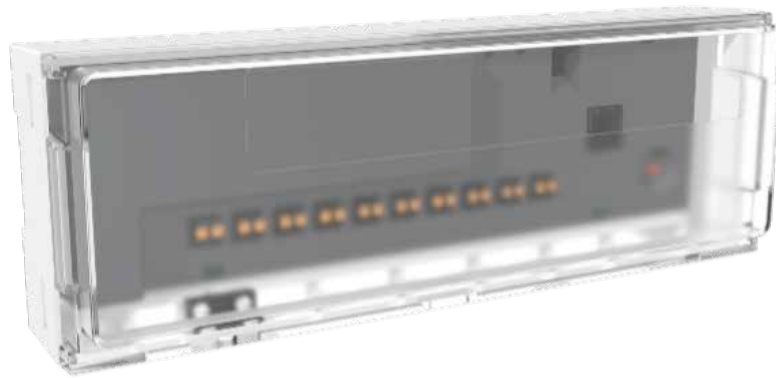

1

2

3

4

5

6

7

8

9

10

11

12



Type: CU-6ZONERF-HC

NEW*
PRODUCT



Base module 6 zones heating/cooling, wireless
Basisstation 6 zones verwarmen/koelen, draadloos
Base module 6 zones chauffer/refroidir, sans fil
Regelkleinleiste 6-zonen Heizen, Funk

Article number	Box / Big Box	Type
CU-6ZONERF-HC	1 pc. / 6 pc.	

Type: CU-10ZONERF-HC

NEW*
PRODUCT



Base module 10 zones heating/cooling, wireless
Basisstation 10 zones verwarmen/koelen, draadloos
Base module 10 zones chauffer/refroidir, sans fil
Regelkleinleiste 10-zonen Heizen/Kuhlen, Funk

Article number	Box / Big Box	Type
CU-10ZONERF-HC	1 pc. / 6 pc.	

Type: CU-ZONERF-HC

NEW*
PRODUCT



Extension module heating/cooling, wireless
Uitbreidingsmodule verwarmen/koelen, draadloos
Module d'extension chauffer/refroidir, sans fil
Erweiterungsmodul Heizen/Kuhlen, Funk

Article number	Box / Big Box	Type
CU-ZONERF-HC	1 pc. / 6 pc.	

Type: CU-ATHERMRF-HC

NEW*
PRODUCT



Analog thermostat heating/cooling, wireless
Analoge thermostaat verwarmen/koelen, draadloos
Thermostat analogue chauffer/refroidir, sans fil
Analog Raumthermostat Heizen/Kuhlen, Funk

Article number	Box / Big Box	Type
CU-ATHERMRF-HC	1 pc. / 36 pc.	

Type: CU-DTHERMRF-HC

NEW*
PRODUCT



Digital thermostat heating/cooling, wireless
Digitale thermostaat verwarmen/koelen, draadloos
Thermostat digitale chauffer/refroidir, sans fil
LCD Raumthermostat Heizen/Kuhlen, Funk

Article number	Box / Big Box	Type
CU-DTHERMRF-HC	1 pc. / 36 pc.	White

Type: CU-DTHERMRF-HC-B

NEW*
PRODUCT



Digital thermostat heating/cooling, wireless, black
Digitale thermostaat verwarmen/koelen, draadloos, zwart
Thermostat digitale chauffer/refroidir, sans fil, noir
LCD Raumthermostat Heizen/Kuhlen, Funk, Schwarz

Article number	Box / Big Box	Type
CU-DTHERMRF-HC-B	1 pc. / 36 pc.	Black

- 1
- 2
- 3
- 4
- 5
- 6
- 7
- 8
- 9
- 10
- 11
- 12



Henco Underfloor Heating

HencoLogic Wireless

1 Type: CU-WIFI

NEW*
PRODUCT



RF Wifi central unit
Centrale RF Wifi unit
Unité centrale RF Wifi
Zentrale RF Wifi-Einheit

Article number	Box / Big Box	Type
CU-WIFIRF	1 pc. / 17 pc.	

6 Type: CU-WIFIRFCABLE

NEW*
PRODUCT



Cable (USB B) RF WIFI central unit
Kabel (USB B) RF WIFI-centrale
Câble (USB B) RF WIFI central unit
Kabel (USB B) RF WIFI zentraleinheit

Article number	Box / Big Box	Type
CU-WIFIRFCABLE	1 pc. / 112 pc.	

12 Type: CU-ANTRF

NEW*
PRODUCT



Antenne

Article number	Box	Type
CU-ANTRF	35 pc.	

Type: CU-REPRF

NEW*
PRODUCT



RF repeater

Article number	Box / Big Box	Type
CU-REPRF	1 pc. / 34 pc.	

Type: CU-RADTHERMRF

NEW*
PRODUCT



RF thermostatic radiator head
RF thermostatische radiator kop
Tête de radiateur thermostatique RF
RF Thermostatischer Heizkörperkopf

Article number	Box / Big Box	Type
CU-RADTHERMRF	1 pc. / 48 pc.	

Type: CU-ACT-B230V

NEW*
PRODUCT



Actuator with cable 1m
Actuator met vaste kabel 1m
Electrovanne avec cable 1m
Stellantrieb Kabel 1m

Article number	Box / Big Box	Type
CU-ACT-B230V	1 pc. / 100 pc.	230V

Henco Underfloor Heating Cabinets



Henco Underfloor Heating Cabinets

NEW*
PRODUCT

Type: UFH-CAB-I



Recessed manifold cabinet, RAL 9016
Verdelerkast voor inbouw, RAL 9016
Boîte à encastrer pour collecteurs, RAL 9016
Verteilerschrank Unterputz, RAL 9016

Article number	Box	Type
UFH-CAB-I400	1 pc.	400x700-800x112-152mm
UFH-CAB-I455*	1 pc.	480x575-665x110-175mm
UFH-CAB-I565*	1 pc.	610x575-665x110-175mm
UFH-CAB-I715*	1 pc.	760x575-665x110-175mm
UFH-CAB-I965*	1 pc.	1010x575x665x110-175mm

*RAL9003

Type: UFH-CAB-O

NEW*
PRODUCT



Surface mount manifold cabinet, RAL 9016
Verdelerkast voor opbouw, RAL 9016
Boîte à poser pour collecteurs, RAL 9016
Verteilerschrank Aufputz, RAL 9016

Article number	Box	Type
UFH-CAB-O385*	1 pc.	385x580x120mm
UFH-CAB-O400	1 pc.	400x720x112mm
UFH-CAB-O615*	1 pc.	615x580x120mm
UFH-CAB-O800	1 pc.	800x720x112mm
UFH-CAB-O1015*	1 pc.	1015x580x120mm

*RAL9003

Type: UFH-CAB-OZ

NEW*
PRODUCT



Surface mount manifold without back, RAL 9003
Verdelerkast zonder rug voor opbouw, RAL 9003
Boîte à poser pour collecteurs sans plaque arrière, RAL 9003
Verteilerschrank Aufputz ohne Rückwand, RAL 9003

Article number	Box	Type
UFH-CAB-O385Z	1 pc.	385x580x120mm
UFH-CAB-O615Z	1 pc.	615x580x120mm
UFH-CAB-O1015Z	1 pc.	1015x580x120mm



	<i>Page</i>
<i>Bending Tools</i>	140
<i>Cutting Tools</i>	141
<i>Calibration Tools</i>	143
<i>Pressing Tools</i>	145
<i>Underfloor Heating Tools</i>	158



Henco Tools

Bending Tools

1 Type: SAFECUT



Cutter to open the packing paper
 Mes om verpakkingspapier te openen
 Couteau pour ouvrir le papier d'emballage
 Schneider zum Öffnen der Verpackung

Article number	Box / Big Box	Type
SAFECUT	1 pc. / 10 pc.	SAFECUT

6 Type: PS



Pipe straightener
 Buizenrichter
 Redresseur
 Rohrbegradiger

Article number	Box / Big Box	Type
PS-16	1 pc. / 30 pc.	Ø16
PS-20	1 pc. / 15 pc.	Ø20

11 Characteristics PS

- ▶ Simplifies installation and reduces labour
- ▶ Easy to use
- ▶ Less material usage and waste
- ▶ Accelerated flow for better efficiencies and reduced running costs
- ▶ Professional looking finish

Type: BI



Internal bending spring
 Binnenbuigveer
 Ressort à plier intérieur
 Biegefeder innen

Article number	Bag / Box	Type
BI-1410	1 pc. / 100 pc.	14x2 L=50 cm
BI-1612	1 pc. / 100 pc.	16x2 L=50 cm
BI-1612L	1 pc. / 50 pc.	16x2 L=100 cm
BI-1814	1 pc. / 75 pc.	18x2 L=50 cm
BI-2016	1 pc. / 75 pc.	20x2 L=50 cm
BI-2016L	1 pc. / 25 pc.	20x2 L=100 cm
BI-2620	1 pc. / 25 pc.	26x3 L=100 cm

Type: BA



External bending spring
 Buitenbuigveer
 Ressort à plier extérieur
 Biegefeder aussen

Article number	Bag / Box	Type
BA-1288	1 pc. / 50 pc.	12x1,88 L=50 cm
BA-1410	1 pc. / 50 pc.	14x2 L=50 cm
BA-1612	1 pc. / 50 pc.	16x2 L=50 cm
BA-1814	1 pc. / 50 pc.	18x2 L=50 cm
BA-2016	1 pc. / 50 pc.	20x2 L=50 cm



Type: BM



Bending tool
Buigijzer
Cintreuse
Biegewerkzeug

Article number	Box / Big Box	Type
BM-16	1 pc. / 15 pc.	for Ø16
BM-18*	1 pc. / NaN	for Ø18
BM-20	1 pc. / 6 pc.	for Ø20
BM-26	1 pc. / 8 pc.	for Ø26

**TILL EXHAUSTION OF STOCK*

Type: BM-F



Fast bending tool
Snelbuig tool
Cintreuse rapide
Schnell Biegewerkzeug

Article number	Box / Big Box	Type
BM-16F	1 pc. / 50 pc.	for Ø16
BM-20F	1 pc. / 40 pc.	for Ø20

Type: IMPRESS



Guillotine cutter for multilayer and protection hose
Guillotineschaar voor meerlagenbuis en mantel
Pince guillotine pour tuyau multicouche et gaine
Guillotinezange für Mehrschichtrohr und Mantel

Article number	Box / Big Box	Type
IM1426PRESS	1 pc. / 36 pc.	14 till 26 mm

Type: IMPRESS-N



Guillotine cutter for multilayer
Guillotineschaar voor meerlagenbuis
Pince guillotine pour tuyau multicouche
Guillotinezange für Mehrschichtrohr

Article number	Box / Big Box	Type
IM1426PRESS-N	1 pc. / 36 pc.	14 till 26 mm

Type: IMEMPRESS



Replacement blade for IMPRESS
Vervangmes voor IMPRESS
Replacement blade for IMPRESS
Ersatzmesser für IMPRESS

Article number	Bag / Box	Type
IMEM1426-PRESS	1 pc. / 150 pc.	14mm - 26mm



Henco Tools

Cutting Tools

Type: RSEM-PERS



Replacement blade for art. RS1420PRESS and RS2640PRESS
 Vervangmes voor art. RS1420PRESS en RS2640PRESS
 Lame pour art. RS1420PRESS et RS2640PRESS
 Ersatzmesser für Art. RS1420PRESS UND RS2640PRESS

Article number	Box	Type
RSEM1420-PERS	1 pc.	14 till 20 mm
RSEM2640-PERS	1 pc.	26 till 40 mm

Type: IM



Wheel cutter
 Buizensnijder
 Coupe-tube
 Rohrschneidezange

Article number	Box / Big Box	Type
IM63	1 pc. / 15 pc.	14 till 63 mm

Type: IMEM



Replacement blade for IM
 Vervangmes voor IM
 Coûteau de rechange pour IM
 Ersatzmesser für IM

Article number	Bag / Box	Type
IMEM63	1 pc. / 150 pc.	14 till 63 mm

Type: RS



Wheel cutter
 Buizensnijder
 Coupe-tube
 Rohrschneidezange

Article number	Box	Type
RS32*	1 pc.	14 till 32 mm

**TILL EXHAUSTION OF STOCK*

Type: PH



Pipe holder for diameters 16-20-26-32
 Griptang voor buis diameter 16-20-26-32
 Pince de maintien diamètre 16-20-26-32
 Rohrhalter für Diameter 16-20-26-32

Article number	Box / Big Box	Type
PH-1632	1 pc. / 70 pc.	16-20-26-32 mm

Characteristics PH

- ▶ Always sufficient grip when calibrating short pipe ends
- ▶ Prevents the pipe from turning during calibration
- ▶ Inspired by the classic nutcracker model
- ▶ Henco blue anodised aluminium
- ▶ Lightweight tool
- ▶ Suitable for pipe diameters of 16 - 20 - 26 - 32





Type: KS-MSET1



Set with KS-K and KS-M for Ø16, 20 and 26
 Set met KS-K en KS-M voor Ø16, 20 en 26
 Set avec KS-K et KS-M pour Ø16, 20 et 26
 Set mit KS-K und KS-M für Ø16, 20 und 26

Article number	Box	Type
KS-MSET1	1 pc.	Ø16,Ø20,Ø26

Type: KS-MSET4



Set with KS-K and KS-M for Ø16, 20, 26 and 32
 Set with KS-K and KS-M for Ø16, 20, 26 and 32
 Set avec KS-K et KS-M pour Ø16, 20, 26 et 32
 Set mit KS-K und KS-M für Ø16, 20, 26 und 32

Article number	Box	Type
KS-MSET4	1 pc.	Ø16,Ø20,Ø26,Ø32

Type: KS



Kalispeed for electric drills (max. 500 rpm, clockwise only)
 Kalispeed voor accu-boormachine (max. 500 toeren, rechts draaien verplicht)
 Kalispeed pour perceuses à batterie (max. 500 tournages, obligation de tourner à droite)
 Kalispeed für Akku-Bohrmaschine (max. 500 Drehungen, rechts drehen verpflichtet)

Article number	Box	Type
KS50	1 pc.	for Ø50
KS63	1 pc.	for Ø63

Type: KS-M



Kalispeed, metal, for KS-K and electric drills (max. 500 rpm, clockwise only)
 Kalispeed, metaal, voor KS-K en accu-boormachine (max. 500 toeren, rechts draaien verplicht)
 Kalispeed, métal, pour KS-K et perceuses à batterie (max. 500 tours, obligation de tourner à droite)
 Kalispeed, Metall, für KS-K und Akku-Bohrmaschine (max. 500 Drehungen, rechts drehen verpflichtet)

Article number	Box	Type
KS12M	1 pc.	for Ø12
KS14M	1 pc.	for Ø14
KS16M	1 pc.	for Ø16
KS18M	1 pc.	for Ø18
KS20M	1 pc.	for Ø20
KS26M	1 pc.	for Ø26
KS32M	1 pc.	for Ø32
KS40M	1 pc.	for Ø40



Henco Tools

Calibration Tools

1 **Type: KS-K**



Clickhandle for KS (Kalispeed)
Klikhandvat voor KS (Kalispeed)
Manche clic pour KS (Kalispeed)
Klickgriff für KS (Kalispeed)

Article number	Box	Type
KS-K	1 pc.	up to Ø63 mm

2
3
4
5
6 **Type: KS-P**



Kalispeed for Ø16, 20 and 26
Kalispeed voor Ø16, 20 en 26
Kalispeed pour Ø16, 20 et 26
Kalispeed für Ø16, 20 und 26

Article number	Box / Big Box	Type
KS-P162026	1 pc. / 288 pc.	for Ø16, 20 and 26

Not for intensive use

7
8
9
10

11

12



Type: M-BA03



Kit: accu-persmachine + accu + lader + koffer, lineaire aandrijving 32 tot 40 kN
 Kit: accu-persmachine + accu + lader + koffer, lineaire aandrijving 32 tot 40 kN
 Kit: machine à sertir + batterie + chargeur + coffret, propulsion linéaire 32 jusqu'à 40 kN
 Kit: Akku-Pressmaschine, lineare Schubkraft 32 bis 40 kN

Article number	Box	Type
M-BA03	1 pc.	Battery

Type: M-BOXBA03



Case for M-BA03
 Koffer voor M-BA03
 Coffre pour M-BA03
 Koffer für M-BOXBA03

Article number	Box	Type
M-BOXBA03	1 pc.	BOX M-BA03

Type: M-BAT03



Battery for M-BA03
 Accu voor M-BA03
 Batterie pour M-BA03
 Akku für M-BA03

Article number	Box	Type
M-BAT03	1 pc.	Battery

- 1
- 2
- 3
- 4
- 5
- 6
- 7
- 8
- 9
- 10
- 11
- 12



Henco Tools

Pressing Tools

1

Type: M-LAD03

2

3

4

5

6



Charge-unit for M-BA03
Lader voor M-BA03
Chargeur pour M-BA03
Akku-Ladegerät für M-BA03

Article number	Box	Type
M-LAD03	1 pc.	Charger

7

Type: M-TRANS

8

9



Main adapter for M-BA03
Adapter voor netaansluiting M-BA03
Adaptateur raccordement au réseau M-BA03
Netzadapter für M-BA03

Article number	Box	Type
M-TRANS03	1 pc.	Adapter

10

11

12

Type: M-BHY162026



Kit : 230V hydraulic press machine with 16, 20, 26 jaws + metal case (110 volt also available), linear drive 32 to 40 kN
Kit : Elektrisch-hydraulische persmachine + bekken 16, 20, 26 + koffer, linaire aandrijving 32 tot 40kN
Kit: machine à sertir électro-hydraulique + pinces 16, 20, 26 + coffret, propulsion linéaire 32 jusqu'à 40 kN
Kit : Elektrohydraulische Pressmaschine + Pressbacken 16, 20, 26 + Koffer, lineare Schubkraft 32 bis 40 kN

Article number	Box	Type
M-BHY162026	1 pc.	Wired 230V

Type: M-BHY



Kit : 230V hydraulic press machine + metal case (110 volt also available), linear drive 32 to 40 kN
Kit : Elektrisch-hydraulische persmachine + koffer, linaire aandrijving 32 tot 40kN
Kit: machine à sertir électro-hydraulique + coffret, propulsion linéaire 32 jusqu'à 40 kN
Kit : Elektrohydraulische Pressmaschine + Koffer, lineare Schubkraft 32 bis 40 kN

Article number	Box	Type
M-BHY	1 pc.	Wired 230V



Type: M-BOXBHY



Metal case for M-BHY162026
Koffer voor M-BHY162026
Coffret en métal pour M-BHY162026
Koffer für M-BHY162026

Article number	Box	Type
M-BOXBHY	1 pc.	Box M-BHY162026

Type: BE



Jaws (universal)
Persbekken (universeel)
PInces à sertir (universel)
Pressbacken (universal)

Article number	Box	Type
BE14	1 pc.	BE/TH 14x2
BE16	1 pc.	BE/TH 16x2
BE18	1 pc.	BE/TH 18x2
BE20	1 pc.	BE/TH 20x2
BE26	1 pc.	BE/TH 26x3
BE32	1 pc.	BE 32x3
BE40	1 pc.	BE 40x3,5
BE50	1 pc.	BE 50x4
BE63	1 pc.	BE 63x4,5

Press tool compatibilty: see www.henco.be

Type: BE-UNISSET1



Set with universal jaw mounting unit and inserts
Set met universele moederbek en wisselbekken
Set avec pince mère universel et pinces
Set mit Mutterpressbacke universal und Backen

Article number	Box	Type
BE-UNISSET1	1 pc.	16, 20 & 26mm

Press tool compatibilty: see www.henco.be

Type: BE-UNISSET2



Set with universal jaw mounting unit and BE-H inserts Ø14, 16, 18, 20, 26, and 32
Set met universele moederbek en wisselbekken BE-H Ø14, 16, 18, 20, 26 en 32
Set avec pince mère universel et pinces BE-H Ø14, 16, 18, 20, 26, et 32
Set mit Mutterpressbacke universal und Backen BE-H Ø14, 16, 18, 20, 26, und 32

Article number	Box	Type
BE-UNISSET2	1 pc.	14, 16, 18, 20, 26 & 32mm

Press tool compatibilty: see www.henco.be



Henco Tools

Pressing Tools

Type: BE-UNISETMINI3



Set with jaw be-mini3 + be-h inserts \varnothing 16,20,26,32
 set met moederbek be-mini3 en wisselbekken be-h \varnothing 16, 20, 26 en 32
 set avec pince mère be-mini3 + pinces be-h \varnothing 16,20,26,32
 set mit mutterpressbacke be-mini3 + backen be-h \varnothing 16,20,26,32

Article number	Box	Type
BE-UNISETMINI3	1 pc.	16, 20, 26 & 32mm

Press tool compatibility: see www.henco.be

Type: TOOLBOX16202632



Box with KS16 20 26 32 M, BE-UNI, BE16 20 26 32 H, BI-1612, BI-2016, BA-1612, BA-2016, RS1420PRESS, SAFECUT
 Koffer met KS16 20 26 32 M, BE-UNI, BE16 20 26 32 H, BI-1612, BI-2016, BA-1612, BA-2016, RS1420PRESS, SAFECUT
 Coffre avec KS16 20 26 32 M, BE-UNI, BE16 20 26 32 H, BI-1612, BI-2016, BA-1612, BA-2016, RS1420PRESS, SAFECUT
 Koffer mit KS16 20 26 32 M, BE-UNI, BE16 20 26 32 H, BI-1612, BI-2016, BA-1612, BA-2016, RS1420PRESS, SAFECUT

Article number	Box	Type
TOOLBOX16202632	1 pc.	16, 20, 26 & 32mm

Press tool compatibility: see www.henco.be

Type: TOOLBOX405063



Box with KS40M, KS50, KS63, BE40 50 63, RS63
 Koffer met KS40M, KS50, KS63, BE40 50 63, RS63
 Coffre avec KS40M, KS50, KS63, BE40 50 63, RS63
 Koffer mit KS40M, KS50, KS63, BE40 50 63, RS63

Article number	Box	Type
TOOLBOX405063	1 pc.	40, 50 & 63mm

Press tool compatibility: see www.henco.be

Type: BE-UNI



Jaw mounting unit for M-BA03 and M-BHY, to be used with BE-H jaws
 Moederbek voor M-BA03 en M-BHY en te gebruiken met BE-H bekken
 Pince mère pour M-BA03 et M-BHY, à utiliser avec pinces BE-H
 Mutterpressbacke für M-BA03 und M-BHY, zu verwenden mit BE-H Backen

Article number	Bag / Big Box	Type
BE-UNI	1 pc. / 12 pc.	MOTHER JAW

BE-UNI is designed to press Henco press fittings, the interchangeable dies with M- and V-profile make it possible to make the transition from other materials to Henco other than Henco branded fittings with compact measurements can cause complex manipulation.



Type: BE-H



Inserts for BE-UNI, BE-MINI2, BE-MINI3, M-BH
Wisselbekken voor BE-UNI, BE-MINI2, BE-MINI3, M-BH
Pincés pour BE-UNI, BE-MINI2, BE-MINI3, M-BH
Pressbacken für BE-UNI, BE-MINI2, BE-MINI3, M-BH

Article number	Bag	Type
BE14H	1 Set (2pc.)	BE/TH 14X2 H
BE16H	1 Set (2pc.)	BE/TH 16X2 H
BE18H	1 Set (2pc.)	BE/TH 18X2 H
BE20H	1 Set (2pc.)	BE/TH 20X2 H
BE26H	1 Set (2pc.)	BE/TH 26X3 H
BE32H	1 Set (2pc.)	BE 32X3 H

Our warranty does not apply to other pipe systems with M or V profile

Type: BE-HC



Inserts (copper) for BE-UNI, BE-MINI2, BE-MINI3, M-BH
Wisselbekken (koper) voor BE-UNI, BE-MINI2, BE-MINI3, M-BH
Pincés (cuivre) pour BE-UNI, BE-MINI2, BE-MINI3, M-BH
Pressbacken (Kupfer) für BE-UNI, BE-MINI2, BE-MINI3, M-BH

Article number	Box	Type
BE12HC	1 Set (2pc.)	12Cu V-profile
BE14HC	1 Set (2pc.)	14Cu V-profile
BE15HC	1 Set (2pc.)	15Cu V-profile
BE16HC	1 Set (2pc.)	16Cu V-profile
BE18HC	1 Set (2pc.)	18Cu V-profile
BE22HC	1 Set (2pc.)	22Cu V-profile
BE28HC	1 Set (2pc.)	28Cu V-profile

Our warranty does not apply to other pipe systems with M or V profile

Type: BE-HM



Inserts (copper) for BE-UNI, BE-MINI2, BE-MINI3, M-BH
Wisselbekken (koper) voor BE-UNI, BE-MINI2, BE-MINI3, M-BH
Pincés (cuivre) pour BE-UNI, BE-MINI2, BE-MINI3, M-BH
Pressbacken (Kupfer) für BE-UNI, BE-MINI2, BE-MINI3, M-BH

Article number	Box	Type
BE12HM	1 Set (2pc.)	12Cu M-profile
BE15HM	1 Set (2pc.)	15Cu M-profile
BE18HM	1 Set (2pc.)	18Cu M-profile
BE22HM	1 Set (2pc.)	22Cu M-profile

Our warranty does not apply to other pipe systems with M or V profile

Type: BE-BOX



Metal case for 6 compression jaws
Stalen koffer voor 6 persbekken
Coffret en métal pour 6 pincés à sertir
Stahlblechkasten für 6 Pressbacken

Article number	Box	Type
BE-BOX	1 pc.	BOX

- 1
- 2
- 3
- 4
- 5
- 6
- 7
- 8
- 9
- 10
- 11
- 12



Henco Tools

Pressing Tools

Type: M-BMINI3-F



Kit : compact rechargeable battery press machine with press monitoring + case + charge unit + battery 18V + full jaws TH16-20-26, linear drive ca. 19 kN

Kit: hydraulische accu-persmachine met persbewaking + koffer + lader + 1 accu 18V + volle bekken TH16-20-26, lineaire aandrijving ca. 19kN

Kit : machine à sertir hydraulique + boîte + chargeur + batterie 18V, pince TH16-20-26, propulsion linéaire ca.19 kN

Kit: Hydraulisches Akku-Presswerkzeug mit Pressdrucküberwachung + Koffer + Ladegerät + 1 Akku 18V + Pressbacken TH16-20-26, lineare Schubkraft ca. 19 kN

Article number	Box	Type
M-BMINI3-F	1 pc.	Battery

Type: M-BMINI3



Hydraulic press machine with battery 18V and linear drive 19kN

Hydraulische persmachine met batterij 18V en lineaire aandrijving 19kN

Machine à sertir hydraulique avec batterie 18V et propulsion linéaire 19kN

Hydraulisches Akku-presswerkzeug mit Akku 18V und lineare Schubkraft 19kN

Article number	Box	Type
M-BMINI3	1 pc.	Battery

Type: M-BMINI3-S



Kit : compact rechargeable battery press machine with press monitoring + case + charge unit + battery 18V, linear drive ca. 19 kN

Kit: hydraulische accu-persmachine met persbewaking + koffer + lader + 1 accu 18V, lineaire aandrijving ca. 19kN

Kit : machine à sertir hydraulique + boîte + chargeur + batterie 18V, propulsion linéaire ca.19 kN

Kit: Hydraulisches Akku-Presswerkzeug mit Pressdrucküberwachung + Koffer + Ladegerät + 1 Akku 18V, lineare Schubkraft ca. 19 kN

Article number	Box	Type
M-BMINI3-S	1 pc.	Battery



Type: M-BATMINI3



Battery 18V for M-BMINI3
Accu 18V voor M-BMINI3
Batterie 18V pour M-BMINI3
Akku 18V für M-BMINI3

Article number	Box	Type
M-BATMINI3-2.0AH	1 pc.	18V / 2,0 Ah Li-ion
M-BATMINI3-5.0AH	1 pc.	18V / 5,0 Ah Li-ion

Type: M-LADMINI3



Charge-unit for M-BMINI3 (-S and -F) + 5m cable
Lader voor M-BMINI3 (-S and -F) + 5m kabel
Chargeur pour M-BMINI3 (-S and -F) + 5m cable
Akku-Ladegerät für M-BMINI3 (-S and -F) + 5m Kabel

Article number	Box	Type
M-LADMINI3	1 pc.	CHARGER

Type: M-TRANSMINI3



Mains adapter for press machines M-BMINI3 (-S and -F) + 5m cable
Adapter voor netaansluiting M-BMINI3 (-S and -F) + 5m kabel
Adaptateur raccordement au réseau M-BMINI3 (-S and -F) + 5m cable
Netzadapter für M-BMINI3 (-S and -F) + 5m Kabel

Article number	Box	Type
M-TRANSMINI3	1 pc.	Adapter

Type: M-BOXMINI3



Metal case for M-BMINI3
Koffer in metaal voor M-BMINI3
Coffret en métal pour M-BMINI3
Koffer in Metal für M-BMINI3

Article number	Box	Type
M-BOXMINI3	1 pc.	CASE

Type: M-BOXMINI3-F



Metal case for M-BMINI3-F
Koffer in metaal voor M-BMINI3-F
Coffret en métal pour M-BMINI3-F
Koffer in Metal für M-BMINI3-F

Article number	Box	Type
M-BOXMINI3-F	1 pc.	CASE

- 1
- 2
- 3
- 4
- 5
- 6
- 7
- 8
- 9
- 10
- 11
- 12



Henco Tools

Pressing Tools

Type: BE-MINI3



Jaw mounting unit for press machine M-BMINI3 and to be used for BE-H jaws
 Moederbek voor persmachine M-BMINI3 en te gebruiken voor BE-H bekken
 Pince mère pour machine à sertir M-BMINI3 et à utiliser pour pinces BE-H
 Mutterpressbacke für Presswerkzeug M-BMINI3, zu verwenden mit BE-H Backen

Article number	Box	Type
BE-MINI3	1 pc.	MOTHER JAW

Press pool compatibility: www.henco.be

Type: BE..-MINI3



Jaw for press machine M-BMINI3 - TH/BE profile
 Bek voor persmachine M-BMINI3 - TH/BE profiel
 Pince pour machine à sertir M-BMINI3 - Profil TH/BE
 Pressbacke für Presswerkzeuge M-BMINI3 + Profil TH/BE

Article number	Box	Type
BE14MINI3	1 pc.	BE/TH Ø14
BE16MINI3	1 pc.	BE/TH Ø16
BE20MINI3	1 pc.	BE/TH Ø20
BE26MINI3	1 pc.	BE/TH Ø26
BE32MINI3	1 pc.	BE Ø32

Press pool compatibility: www.henco.be

Type: BE.V-MINI3



Jaw for press machine M-BMINI3 - V-profile
 Bek voor persmachine M-BMINI3 - V-profiel
 Pince pour machine à sertir M-BMINI3 - Profil V
 Pressbacke für Presswerkzeuge M-BMINI3 - Profil V

Article number	Box	Type
BE15V-MINI3	1 pc.	V-profile 15mm
BE18V-MINI3	1 pc.	V-profile 18mm
BE22V-MINI3	1 pc.	V-profile 22mm
BE28V-MINI3	1 pc.	V-profile 28mm

Our warranty does not apply to other pipe systems with M or V profile.
 Press pool compatibility: www.henco.be

Type: BE.M-MINI3



Jaw for press machine M-BMINI3 - M-profile
 Bek voor persmachine M-BMINI3 - M-profiel
 Pince pour machine à sertir M-BMINI3 - Profil M
 Pressbacke für Presswerkzeuge M-BMINI3 - Profil M

Article number	Box	Type
BE12M-MINI3	1 pc.	M-profile 12mm
BE15M-MINI3	1 pc.	M-profile 15mm
BE18M-MINI3	1 pc.	M-profile 18mm
BE22M-MINI3	1 pc.	M-profile 22mm
BE28M-MINI3	1 pc.	M-profile 28mm

Our warranty does not apply to other pipe systems with M or V profile.
 Press pool compatibility: www.henco.be



Type: M-BATMINI2



Battery 18V / 1,5 Ah Li-ion for M-BMINI2
 Accu 18V / 1,5 Ah Li-ion voor M-BMINI2
 Batterie 18V / 1,5 Ah Li-ion pour M-BMINI2
 Akku 18V / 1,5 Ah Li-ion für M-BMINI2

Article number	Box	Type
M-BATMINI2	1 pc.	18V / 1,5 Ah Li-ion

Type: BE..-MINI



Jaw for press machine M-BMINI2(-S) and M-HP32
 Bek voor persmachine M-BMINI2(-S) en M-HP32
 Pince pour machine à sertir M-BMINI2(-S) et M-HP32
 Pressbacke für Presswerkzeuge M-BMINI2(-S) und M-HP32

Article number	Box	Type
BE16MINI	1 pc.	BE/TH Ø16
BE20MINI	1 pc.	BE/TH Ø20
BE26MINI	1 pc.	BE/TH Ø26
BE32MINI	1 pc.	BE Ø32

Not applicable to press machine type M-BMINI3

Type: BE..-MMINI



M-profile jaw (copper) for press machine M-BMINI(2)(-S) and M-HP32
 M-profiel bek (koper) voor persmachine M-BMINI(2)(-S) en M-HP32
 M-profil pince (cuivre) pour machine à sertir M-BMINI(2)(-S) et M-HP32
 M-profil Pressbacke (Kupfer) für Presswerkzeuge M-BMINI(2)(-S) und M-HP32

Article number	Bag	Type
BE15MMINI	1 pc.	Ø15Cu M-Profil
BE22MMINI	1 pc.	Ø22Cu M-Profil

Not applicable to press machine type M-BMINI3

Type: BE-C



V-profile jaw (copper) for press machine M-BMINI2(-S) and M-HP32
 V-profiel persbek (koper) voor persmachine M-BMINI2(-S) and M-HP32
 V-profil pince (cuivre) pour machine à sertir M-BMINI2(-S) et M-HP32
 V-profil Pressbacke (Kupfer) für Presswerkzeuge M-BMINI2(-S) und M-HP32

Article number	Bag	Type
BE15C	1 pc.	Ø15Cu V-Profil
BE18C	1 pc.	Ø18Cu V-Profil
BE22C	1 pc.	Ø22Cu V-Profil
BE28C	1 pc.	Ø28Cu V-Profil

Not applicable to press machine type M-BMINI3

Our warranty does not apply to other pipe systems with M or V profile.

Type: BE-MINI



Jaw mounting unit for press machine M-BMINI(2)(-S) / M-HP32 and to be used with BE-H jaws
 Bek voor persmachine M-BMINI2(-S) en M-HP-32 en te gebruiken met BE-H persbekken
 Pince mère pour machine à sertir M-BMINI(2)(-S) / M-HP32 et à utiliser avec pinces BE-H
 Mutterpressbacke für Presswerkzeug M-BMINI(2)(-S) / M-HP32, zu verwenden mit BE-H Backen

Article number	Box	Type
BE-MINI	1 pc.	MOTHERJAW

BE-MINI is designed to press Henco press fittings, the interchangeable dies with M- and V-profile make it possible to make the transition from other materials to Henco; other than Henco branded fittings with compact measurements can cause complex manipulation



Henco Tools

Pressing Tools

Type: BEMINI-RMS



Jaw for REMS mini press machines
 Bek voor REMS mini persmachines
 Pince pour machine à sertir mini REMS
 Pressbacke für mini REMS Presswerkzeuge

Article number	Box	Type
BE16MINI-RMS	1 pc.	BE/TH Ø16
BE20MINI-RMS	1 pc.	BE/TH Ø20
BE26MINI-RMS	1 pc.	BE/TH Ø26
BE32MINI-RMS	1 pc.	BE Ø32

Type: M-HP



Hydraulic manual press tool + bag
 Hydraulisch handpersmachine + draagtas
 Machine à sertir manuelle hydraulique + sac
 Hydraulisches Handpressmaschine + Tasche

Article number	Bag	Type
M-HP32	1 pc.	Ø14-32

Type: M-BH



Kit: manual press machine + inserts 16,20,26 + bag
 Kit: handpersmachine + bekken 16, 20, 26 + draagtas
 Kit: machine à sertir manuelle + pinces 16, 20, 26 + sac
 Kit: Handpersmaschine + Pressbacken 16, 20, 26 + Tasche

Article number	Bag	Type
M-BH162026	1 pc.	Ø16-20-26

*TILL EXHAUSTION OF STOCK
 Not for intensive use*

Type: M-BM1620



Kit: manual press machine with 16, 20 jaws + bag
 Kit: handpersmachine + wisselbekken 16, 20 + draagtas
 Kit: machine à sertir manuelle + pinces 16, 20 + sac
 Kit: Handpressmaschine + Pressbacken 16, 20 + Tasche

Article number	Bag	Type
M-BM1620	1 pc.	Ø16-20 mm

Type: BE-M



Inserts for M-BM1620
 Wisselbekken voor M-BM1620
 Pinces pour M-BM1620
 Pressbacken für M-BM1620

Article number	Bag	Type
BE14M	1 pc.	BE/TH 14X2
BE16M	1 pc.	BE/TH 16X2
BE18M	1 pc.	BE/TH 18X2
BE20M	1 pc.	BE/TH 20X2



Type: HNTOOLSET



Toolset for the SUPER SIZES range
Toolset voor het SUPER SIZES gamma
Set d'outil pour la gamme SUPER SIZES
Toolset für das SUPER SIZES Angebot

Article number	Box	Type
HNTOOLSET	1 pc.	Super Sizes

Type: PRESSCHECK



Tool to control the accuracy of a pressing
Instrument om correctheid v/e persing te controleren
Outil pour contrôler la précision d'un sertissage
Instrument zur Überprüfung ob die Pressung korrekt ausgeführt

Article number	Bag / Box	Type
PRESSCHECK1432	1 pc. / 200 pc.	Ø14-32

Type: DRILLY



Drilly temporary air vent plug, reusable
Drilly voor afdrukken leidingssysteem, herbruikbaar
Drilly pour tester le système de tubes, réutilisable
Drilly zum abdrucken Rohresysteme, wieder verwendbar

Article number	Box	Type
DRILLY14	1 pc.	Ø14
DRILLY16	1 pc.	Ø16
DRILLY20	1 pc.	Ø20
DRILLY26	1 pc.	Ø26
DRILLY32	1 pc.	Ø32

Type: PLUG



Plug
Afdrukplug
Bouchon
Stopf

Article number	Box / Big Box	Type
PLUG04-B80	20 pc. / 360 pc.	1/2" - 80 mm blue
PLUG04-R80	20 pc. / 360 pc.	1/2" - 80 mm red
PLUG05-B80	20 pc. / 160 pc.	3/4" - 80 mm blue
PLUG05-R80	20 pc. / 160 pc.	3/4" - 80 mm red

- 1
- 2
- 3
- 4
- 5
- 6
- 7
- 8
- 9
- 10
- 11
- 12



Henco Tools

Pressing Tools

Type: PK-TOOL



Wrench for PK/SK fittings with threading
 Sleutel voor PK/SK fittings met draad
 Clé pour raccords PK/SK filtage
 Schlüssel für PK/SK Fittings mit Draht

Article number	Box / Big Box	Type
PK-TOOL04	1 pc. / 50 pc.	1/2"
PK-TOOL05	1 pc. / 50 pc.	3/4"
PK-TOOL06	1 pc. / 50 pc.	1"

Characteristics PK-TOOL

- ▶ Light weight ratchet key
- ▶ Full grip around fitting profile
- ▶ Plastic body stays intact, even when applying extreme torque
- ▶ Key works as well in clock- as counterclockwise direction
- ▶ Maximum torque transition
- ▶ Size indication on handle
- ▶ Chromed handle
- ▶ Key gripping jaws in anodized aluminum
- ▶ Possibility to grip around mounted fittings due to specific closing mechanism



Type: PK-TOOLBOX-040506



Set Wrenches for PK/SK Fittings 1/2" - 1" Threading
 Set sleutels voor PK/SK fittings 1/2" tot 1" draad
 Set Clés pour raccords PK/SK filtage 1/2" - 1"
 Set Schlüssel für PK/SK Fittings 1/2" bis 1" Draht

Article number	Box	Type
PK-TOOLBOX-040506	1 pc.	CASE

Type: PK-TOOLBOX



Empty plastic case for PK-TOOL04/05/06
 Set sleutels voor PK/SK fittings 1/2" tot 1" draad
 Coffret pour PK-TOOL04/05/06
 Koffer für PK-TOOLBOX04/05/06

Article number	Box / Big Box	Type
PK-TOOLBOX	1 pc. / 10 pc.	CASE



Type: UFH-VLA



Decoiler, Standard model
Haspel, basismodel
Machine à dérouler, Standard
Abwickelmaschine, Standard

Article number	Box	Type
UFH-VLA	1 pc.	25m -600m

Minimum inner diameter coil: 140mm

Type: UFH-VLA-STR



Pipe straightener for decoiler UFH-VLA 14-26mm
Stangenrechter voor haspel UFH-VLA 14-26mm
Machine à produire des barres pour dérouler UFH-VLA 14-26mm
Stangenmaschine für Wickelmaschine UFH-VLA 14-26mm

Article number	Box	Type
UFH-VLA-STR	1 pc.	14-26mm

Type: UFH-TACK



Tacker machine for UFH-TACK-40, UFH-TACK-60
Tackerapparaat voor UFH-TACK-40, UFH-TACK-60
Appareil Tacker pour UFH-TACK-40, UFH-TACK-60
Tackergerät für UFH-TACK-40, UFH-TACK-60

Article number	Box	Type
UFH-TACK	1 pc.	for UFH-TACK-40 / UFH-TACK-60

- 1
- 2
- 3
- 4
- 5
- 6
- 7
- 8
- 9
- 10
- 11
- 12



Henco Tools

Underfloor Heating Tools

1 **Type: UFH-RAS-VLE**



Braid hook
Vlechthaak
Crochet de tressage
Gerät zum Flechten von Stahldraht

Article number	Box	Type
UFH-RAS-VLE	1 pc.	

2
3
4
5
6 **Type: UFH-RAS-CUT**



Cutter for steel mesh
Kniptang voor stalen draadmatten
Pince coupante pour treillis
Schere für Trägermatte

Article number	Box	Type
UFH-RAS-CUT	1 pc.	

7
8
9
10
11
12

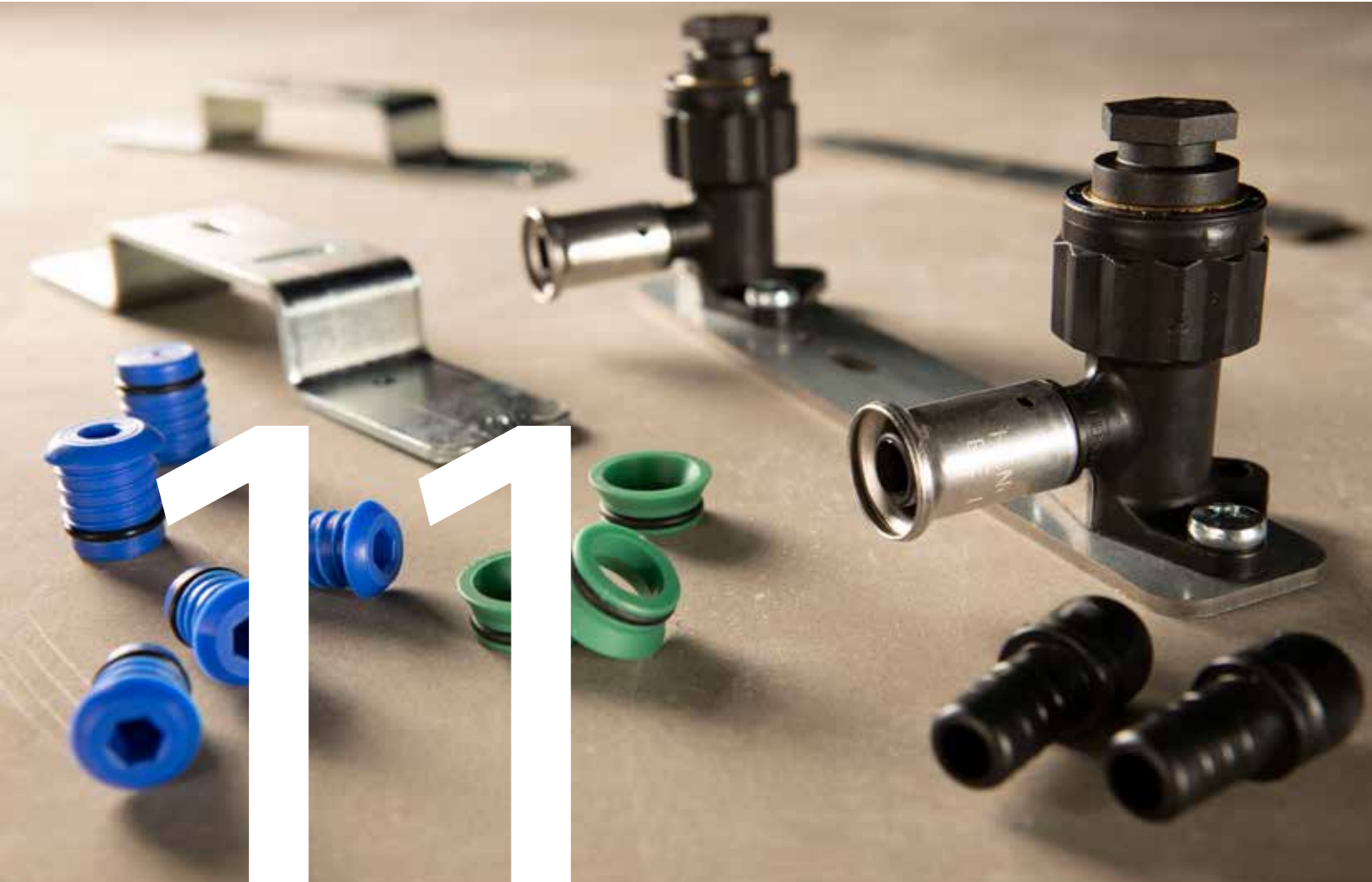



Henco Accessories

Type: BCLIP



Clip-it clip for Henco pipes, single
 Clip-it beugel voor Henco buizen, enkel
 Clip-it attache de fixation pour tubes henco, simple
 Clip-it Bügel für Henco Rohre, einfach

Article number	Box	Type
BCLIP-16	100 pc.	Ø16
BCLIP-1820	100 pc.	Ø18 - 20
BCLIP-26	100 pc.	Ø26
BCLIP-32	100 pc.	Ø32
BCLIP-40*	100 pc.	Ø40
BCLIP-50*	50 pc.	Ø50

**TILL EXHAUSTION OF STOCK*

Type: JCLIP



J-clip pipe clips, single
 J-clip beugels, enkel
 Attaches de fixation J-clip, simple
 J-clip Haken, einfach

Article number	Box	Type
JCLIP-1632	200 pc.	Ø16-32, 70 mm

Type: JCLIP L



J-clip pipe clips, single, long
 J-clip beugels, enkel, lang
 Attaches de fixation J-clip, simple, long
 J-clip Haken, einfach, lang

Article number	Box	Type
JCLIP-1632L	200 pc.	Ø16-32, 97 mm

Type: JCLIP DOUBLE



J-clip pipe clips, double
 J-clip beugels, dubbel
 Attaches de fixation J-clip, double
 J-clip Haken, doppelt

Article number	Box	Type
JCLIP-1632D	200 pc.	Ø16-32, 70 mm

Type: JCLIP DOUBLE L



J-clip pipe clips, double long
 J-clip beugels, dubbel lang
 Attaches de fixation J-clip, double long
 J-clip Haken, doppelt lang

Article number	Box	Type
JCLIP-1632DL	200 pc.	Ø16-32, 97 mm



Type: PIPEPLUG



Protection cap for pipe
 Beschermstopje voor buis
 Capuchon de protection pour tube
 Schutzkappe für Rohr

Article number	Bag / Box	Type
PIPEPLUG16	100 pc. / 700 pc.	Ø 16
PIPEPLUG20	100 pc. / 500 pc.	Ø 20
PIPEPLUG26	100 pc. / 300 pc.	Ø 26

Type: PLP-P-PK



Galvanised bracket for backplate elbow
 Gebogen tappuntbeugel gegalvaniseerd
 Support galvanisé pour culasse sanitaire
 Halteplatte galvanisiert

Article number	Bag / Box	Type
PLP-P-PK	1 pc. / 20 pc.	ELBOW

Interaxis 153mm

Type: PLF-P-PK



Galvanised bracket flat for backplate elbow
 Vlakke tappuntbeugel gegalvaniseerd
 Support galvanisé pour culasse sanitaire
 Halteplatte flach galvanisiert

Article number	Bag / Box	Type
PLF-P-PK	1 pc. / 40 pc.	FLAT

Interaxis 120mm and 153mm

Type: TESTPLUG



Testcap blue for Henco pipe
 Kunststof afpersplug blauw voor Henco buis
 Capuchon de teste blue pour tube
 Testkappe blau für Rohr

Article number	Bag / Box	Type
TESTPLUG16	20 pc. / 4000 pc.	Ø16
TESTPLUG20	20 pc. / 2000 pc.	Ø20
TESTPLUG26	20 pc. / 1000 pc.	Ø26

Type: TESTPLUG-RO



Testcap red for Henco pipe
 Kunststof afpersplug rood voor Henco buis
 Capuchon de teste rouge pour tube
 Testkappe roth für Rohr

Article number	Bag / Box	Type
TESTPLUG16-RO	20 pc. / 4000	Ø16
TESTPLUG20-RO	20 pc. / 2000	Ø20
TESTPLUG26-RO	20 pc. / 1000	Ø26

NEW*
 PRODUCT



Henco Accessories

1 Type: AK-EK



Adapter from 3/4" EK to flat sealing
 Adapter kunststof - EK 3/4" naar vlakdichtend
 Adapteur EK 3/4" vers joint plat
 Adapter von EK 3/4" nach AG Flachdichtend

Article number	Bag / Big Box	Type
AK-EK05VD	50 pc. / 1000 pc.	

6 Type: BD



Montage-/hersteltape
 Montage-/hersteltape
 Montage-/hersteltape
 Montage-/hersteltape

Article number	Box	Type
BDR33M	36 pc.	33m x 50mm / Red
BDB33M	36 pc.	33m x 50mm / Blue

11 Type: HFMAN



EPDM sleeve for hencoflex
 EPDM manchette hencoflex
 Manchon EPDM pour hencoflex
 EPDM Hülse für Hencoflex

Article number	Bag / Box	Type
HFMAN125	1 pc. / 30 pc.	





	<i>Page</i>
<i>Sprinkler Standard (PE-Xc/AL/PE-Xc) Pipes</i>	<i>164</i>
<i>Henco Press Sprinkler</i>	<i>165</i>
<i>Henco Pro-Sprinkler</i>	<i>171</i>
<i>Sprinkler Tools</i>	<i>175</i>



Henco Sprinkler

SPRINKLER STANDARD (PE-Xc/AL/PE-Xc) Pipes

1 Type: STRAIGHT LENGTH SPR



Henco multilayer pipe SPRINKLER (Straight length)
Henco meerlagenbuis SPRINKLER (Stang)
Henco tube multicouche SPRINKLER (Barre)
Henco Mehrschichtverbundrohr SPRINKLER (Stange)

Article number	Cylinder / Pallet	Type
05-320326-SPR	35 m / 1680 m	32x3
05-403533-SPR	45 m / 1080 m	40x3,5
05-504042-SPR	35 m / 840 m	50x4
05-634554-SPR	20 m / 480 m	63x4,5

8 Type: COIL SPR



Henco multilayer pipe SPRINKLER (Coil)
Henco meerlagenbuis SPRINKLER (rol)
Henco tube multicouche SPRINKLER (Rouleau)
Henco Mehrschichtverbundrohr SPRINKLER (Rohr)

Article number	Coil / Pallet	Type
50-320326-SPR	50 m / 650 m	32x3



Type: 1PKS



Elbow 90°
Knie 90°
Coude 90°
Winkel 90°

Article number	Bag / Box	Type
1PKS-3232	5 pc. / 30 pc.	32x32
1PKS-4040	5 pc. / 20 pc.	40x40
1PKS-5050	1 pc. / 8 pc.	50x50
1PKS-6363	1 pc. / 6 pc.	63x63

Type: 5PKS (CW617)



Elbow 90° male adapter
Knie 90° buitendraad
Coude 90° mâle
Winkel 90° AG

Article number	Bag / Box	Type
5PKS-3206	5 pc. / 20 pc.	32x1"
5PKS-4007	3 pc. / 15 pc.	40x5/4"
5PKS-5007	1 pc. / 10 pc.	50x1 1/4"
5PKS-5008	1 pc. / 8 pc.	50x6/4"
5PKS-6310	1 pc. / 4 pc.	63x2"

Type: 5PKS-N (CW602)



Elbow 90° male adapter CW602
Knie 90° buitendraad CW602
Elbow 90° male adapter CW602
Elbow 90° male adapter CW602

Article number	Bag / Box	Type
5PKS-3206-N	5 pc. / 20 pc.	32x1"
5PKS-4007-N	3 pc. / 15 pc.	40x5/4"
5PKS-5007-N	1 pc. / 10 pc.	50x5/4"
5PKS-5008-N	1 pc. / 8 pc.	50x6/4"
5PKS-6310-N	1 pc. / 4 pc.	63x2"

Type: 6PKS (CW617)



Elbow 90° female adapter
Knie 90° binnendraad
Coude 90° femelle
Winkel 90° IG

Article number	Bag / Box	Type
6PKS-3204	5 pc. / 20 pc.	32x1/2"
6PKS-3206	5 pc. / 20 pc.	32x1"
6PKS-4004	5 pc. / 15 pc.	40x1/2"
6PKS-4007	5 pc. / 15 pc.	40x5/4"
6PKS-5004	1 pc. / 8 pc.	50x1/2"
6PKS-5007	1 pc. / 8 pc.	50x5/4"
6PKS-5008	1 pc. / 8 pc.	50x6/4"
6PKS-6304	1 pc. / 4 pc.	63x1/2"
6PKS-6310	1 pc. / 4 pc.	63x2"

- 1
- 2
- 3
- 4
- 5
- 6
- 7
- 8
- 9
- 10
- 11
- 12



Henco Sprinkler

Henco Press SPRINKLER

Type: 6PKS-N (CW602)



Elbow 90° female adapter
Knie 90° binnendraad
Elbow 90° female adapter
Elbow 90° female adapter

Article number	Bag / Box	Type
6PKS-3204-N	5 pc. / 20 pc.	32x1/2"
6PKS-3206-N	5 pc. / 20 pc.	32x1"
6PKS-4004-N	5 pc. / 15 pc.	40x1/2"
6PKS-4007-N	5 pc. / 15 pc.	40x5/4"
6PKS-5004-N	1 pc. / 8 pc.	50x1/2"
6PKS-5007-N	1 pc. / 8 pc.	50x5/4"
6PKS-5008-N	1 pc. / 8 pc.	50x6/4"
6PKS-6304-N	1 pc. / 4 pc.	63x1/2"
6PKS-6310-N	1 pc. / 4 pc.	63x2"

Type: 9PKS



T-piece
T-stuk
Pièce en T
T-Stück

Article number	Bag / Box	Type
9PKS-323232	5 pc. / 15 pc.	32x32x32
9PKS-404040	5 pc. / 10 pc.	40x40x40
9PKS-505050	1 pc. / 6 pc.	50x50x50
9PKS-636363	1 pc. / 3 pc.	63x63x63

Type: 10PKS



T-reduced centre
T-verlopend
Pièce en T réduit
T-reduziert

Article number	Bag / Box	Type
10PKS-403240	5 pc. / 10 pc.	40x32x40
10PKS-503250	1 pc. / 8 pc.	50x32x50
10PKS-504050	1 pc. / 6 pc.	50x40x50
10PKS-633263	1 pc. / 3 pc.	63x32x63
10PKS-634063	1 pc. / 3 pc.	63x40x63
10PKS-635063	1 pc. / 3 pc.	63x50x63

Type: 11PKS



T-branch and line reduced
T-2x verlopend
Pièce en T 2x réduit
T-2x reduziert

Article number	Bag / Box	Type
11PKS-403232	5 pc. / 10 pc.	40x32x32
11PKS-404032	5 pc. / 10 pc.	40x40x32
11PKS-503240	1 pc. / 10 pc.	50x32x40
11PKS-504040	1 pc. / 8 pc.	50x40x40



Type: 12PKS



T-enlarged branch
T-vergroot
Pièce en T agrandi
T-erweitert

Article number	Bag / Box	Type
12PKS-324032	5 pc. / 15 pc.	32x40x32
12PKS-405040	1 pc. / 8 pc.	40x50x40

Type: 13PKS (CW617)



T-female centre
T-binnendraad
Pièce en T femelle
T-IG

Article number	Bag / Box	Type
13PKS-320432	5 pc. / 15 pc.	32x1/2"x32
13PKS-320532	5 pc. / 15 pc.	32x3/4"x32
13PKS-320632	5 pc. / 10 pc.	32x1"x32
13PKS-320732	5 pc. / 10 pc.	32x5/4"x32
13PKS-400440	5 pc. / 10 pc.	40x1/2"x40
13PKS-400640	5 pc. / 10 pc.	40x1"x40
13PKS-400740	5 pc. / 10 pc.	40x5/4"x40
13PKS-500450	1 pc. / 4 pc.	50x1/2"x50
13PKS-500550	1 pc. / 4 pc.	50x3/4"x50
13PKS-500850	1 pc. / 4 pc.	50x6/4"x50
13PKS-630463	1 pc. / 2 pc.	63x1/2"x63
13PKS-631063	1 pc. / 2 pc.	63x2"x63

Type: 13PKS-N (CW602)



T-female centre
T-binnendraad
Pièce en T femelle
T-IG

Article number	Bag / Box	Type
13PKS-320432-N	5 pc. / 15 pc.	32x1/2"x32
13PKS-320532-N	5 pc. / 15 pc.	32x3/4"x32
13PKS-320632-N	5 pc. / 10 pc.	32x1"x32
13PKS-320732-N	5 pc. / 10 pc.	32x5/4"x32
13PKS-400440-N	5 pc. / 10 pc.	40x1/2"x40
13PKS-400640-N	5 pc. / 10 pc.	40x1"x40
13PKS-400740-N	5 pc. / 10 pc.	40x5/4"x40
13PKS-500550-N	1 pc. / 4 pc.	50x3/4"x50
13PKS-500850-N	1 pc. / 4 pc.	50x6/4"x50
13PKS-630463-N	1 pc. / 2 pc.	63x1/2"x63
13PKS-631063-N	1 pc. / 2 pc.	63x2"x63

- 1
- 2
- 3
- 4
- 5
- 6
- 7
- 8
- 9
- 10
- 11
- 12



Henco Sprinkler

Henco Press SPRINKLER

Type: 14PKS (CW617)



T-male centre
T-buitendraad
Pièce en T mâle
T-AG

Article number	Bag / Box	Type
14PKS-320532	5 pc. / 15 pc.	32x3/4"x32
14PKS-400640	5 pc. / 10 pc.	40x1"x40
14PKS-400740	5 pc. / 10 pc.	40x5/4"x40
14PKS-500850	1 pc. / 5 pc.	50x6/4"x50
14PKS-631063	1 pc. / 2 pc.	63x2"x63

Type: 14PKS-N (CW602)



T-male centre
T-buitendraad
Pièce en T mâle
T-AG

Article number	Bag / Box	Type
14PKS-320532-N	5 pc. / 15 pc.	32x3/4"x32
14PKS-400640-N	5 pc. / 10 pc.	40x1"x40
14PKS-400740-N	5 pc. / 10 pc.	40x5/4"x40
14PKS-500850-N	1 pc. / 5 pc.	50x6/4"x50
14PKS-631063-N	1 pc. / 2 pc.	63x2"x63

Type: 15PKS



Straight coupling
Perssok
Manchon
Kupplung

Article number	Bag / Box	Type
15PKS-3232	5 pc. / 30 pc.	32x32
15PKS-4040	5 pc. / 25 pc.	40x40
15PKS-5050	1 pc. / 12 pc.	50x50
15PKS-6363	1 pc. / 9 pc.	63x63

Type: 16PKS



Reducing coupling
Verloopstuk
Réduction
Kupplung-reduziert

Article number	Bag / Box	Type
16PKS-4032	5 pc. / 25 pc.	40x32
16PKS-5032	1 pc. / 15 pc.	50x32
16PKS-5040	1 pc. / 15 pc.	50x40
16PKS-6340	1 pc. / 8 pc.	63x40
16PKS-6350	1 pc. / 8 pc.	63x50



Type: 17PKS (CW617)



Straight male adapter
Puntstuk
Raccord droit mâle
Übergangsfitting AG

Article number	Bag / Box	Type
17PKS-3206	10 pc. / 40 pc.	32x1"
17PKS-3207	5 pc. / 25 pc.	32x5/4"
17PKS-4006	5 pc. / 25 pc.	40x1"
17PKS-4007	5 pc. / 25 pc.	40x5/4"
17PKS-5008	1 pc. / 10 pc.	50x6/4"
17PKS-6310	1 pc. / 6 pc.	63x2"

Type: 17PKS-N (CW602)



Straight male adapter
Puntstuk
Raccord droit mâle
Übergangsfitting AG

Article number	Bag / Box	Type
17PKS-3206-N	10 pc. / 40 pc.	32x1"
17PKS-3207-N	5 pc. / 25 pc.	32x5/4"
17PKS-4006-N	5 pc. / 25 pc.	40x1"
17PKS-4007-N	5 pc. / 25 pc.	40x5/4"
17PKS-5008-N	1 pc. / 10 pc.	50x6/4"
17PKS-6310-N	1 pc. / 6 pc.	63x2"

Type: 18PKS (CW617)



Straight female adapter
Recht aansluitstuk binnendraad
Raccord droit femelle
Übergangsfitting IG

Article number	Bag / Box	Type
18PKS-3204	10 pc. / 40 pc.	32x1/2"
18PKS-3206	10 pc. / 40 pc.	32x1"
18PKS-3207	5 pc. / 25 pc.	32x5/4"
18PKS-4006	5 pc. / 25 pc.	40x1"
18PKS-4007	5 pc. / 25 pc.	40x5/4"
18PKS-5008	1 pc. / 10 pc.	50x6/4"
18PKS-6310	1 pc. / 6 pc.	63x2"

Type: 18PKS-N (CW602)



Straight female adapter
Recht aansluitstuk binnendraad
Raccord droit femelle
Übergangsfitting IG

Article number	Bag / Box	Type
18PKS-3204-N	10 pc. / 40 pc.	32x1/2"
18PKS-3206-N	10 pc. / 40 pc.	32x1"
18PKS-3207-N	5 pc. / 25 pc.	32x5/4"
18PKS-4006-N	5 pc. / 25 pc.	40x1"
18PKS-4007-N	5 pc. / 25 pc.	40x5/4"
18PKS-5008-N	1 pc. / 10 pc.	50x6/4"
18PKS-6310-N	1 pc. / 6 pc.	63x2"

- 1
- 2
- 3
- 4
- 5
- 6
- 7
- 8
- 9
- 10
- 11
- 12



Henco Sprinkler

Henco Press SPRINKLER

1 Type: 27PKS



Elbow 45°
Knie 45°
Coude 45°
Winkel 45°

Article number	Bag / Box	Type
27PKS-3232	5 pc. / 30 pc.	32x32
27PKS-4040	5 pc. / 25 pc.	40x40
27PKS-5050	1 pc. / 10 pc.	50x50
27PKS-6363	1 pc. / 5 pc.	63x63

7 Type: 52PS



Mounting/repair fitting
Montage/reparatie fitting Sprinkler
Raccord montage/reparation
Montage/reparatur fitting

Article number	Bag / Box	Type
52PS32	1 pc. / 20 pc.	32x32

12 Type: 53PKS



Easymounting/repair fitting
Montage/reparatie fitting Sprinkler
Raccor montage/reparation
Montage/reparatur fitting

Article number	Bag / Box	Type
53PKS40	1 pc. / 20 pc.	40x40
53PKS50	1 pc. / 9 pc.	50x50
53PKS63	1 pc. / 6 pc.	63x63

Type: 50P



Stainless steel sprinkler connection with stainless steel cup
RVS instort sprinkler-aansluiting met RVS cup
Raccord sprinkler en acier inoxydable avec coupelle en acier inoxydable
Sprinkler-Anschluss aus Edelstahl mit Edelstahltasse

Article number	Bag / Box	Type	Height
50P-3206	1 pc. / 15 pc.	32x1"	23 mm
50P-320604	1 pc. / 15 pc.	32x1/2"	23 mm
50P-320605	1 pc. / 15 pc.	32x3/4"	23 mm
50P43-320604	1 pc. / 15 pc.	32x1"	40 mm



Type: 6PKS-OP (CW617N)



T-female branch with pressure test plug
 T-binnendraad met afpersplug
 Pièce en T femelle avec bouchon pour essai de pression
 T-IG mit Stopfen für für Prüfdruck

Article number	Bag / Box	Type
6PKS-3206OP	5 pc. / 20 pc.	32x1" + plug

Type: 6PKS-OP-CS (CW724N)



T-female branch with pressure test plug (CW724N)
 T-binnendraad met afpersplug (CW724N)
 Pièce en T femelle avec bouchon pour essai de pression (CW724N)
 T-IG mit Stopfen für für Prüfdruck (CW724N)

Article number	Bag / Box	Type
6PKS-3206OP-CS	5 pc. / 20 pc.	32x1" + plug

Type: 13PKS-OP (CW617N)



T-female branch with pressure test plug
 T-binnendraad met afpersplug
 Pièce en T femelle avec bouchon pour essai de pression
 T-IG mit Stopfen für für Prüfdruck

Article number	Bag / Box	Type
13PKS-320632OP	5 pc. / 10 pc.	32x1"x32 + plug

Type: 13PKS-OP-CS (CW724N)



T-female branch with pressure test plug (CW724N)
 T-binnendraad met afpersplug (CW724N)
 Pièce en T femelle avec bouchon pour essai de pression (CW724N)
 T-IG mit Stopfen für für Prüfdruck (CW724N)

Article number	Bag / Box	Type
13PKS-320632OP-CS	5 pc. / 10 pc.	32x1"x32 + plug

Type: 18PKS-OP (CW617N)



Straight female adapter with pressure test plug
 Recht aansluitstuk binnendraad met afpersplug
 Raccord droit femelle avec bouchon pour essai de pression
 Übergangsfitting IG mit Stopfen für für Prüfdruck

Article number	Bag / Box	Type
18PKS-3206OP	10 pc. / 40 pc.	32x1" + plug

Type: 18PKS-OP-CS (CW724N)



Straight female adapter with pressure test plug (CW724N)
 Recht aansluitstuk binnendraad met afpersplug (CW724N)
 Raccord droit femelle avec bouchon pour essai de pression (CW724N)
 Übergangsfitting IG mit Stopfen für für Prüfdruck (CW724N)

Article number	Bag / Box	Type
18PKS-3206OP-CS	10 pc. / 40 pc.	32x1" + plug



Henco Sprinkler

Henco PRO-sprinkler

NEW PRODUCT

Type: SPR-OP

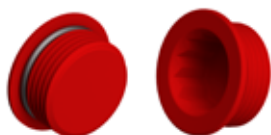

Pressure test plug with O-ring
 Afpersplug met O-ring
 Bouchon avec joint torique pour essai de pression
 Stopfen mit O-Ring für Prüfdruck

Article number	Bag / Box	Type
SPR-OP06	100 pc. / 800	1"

Type: SPR-CBLOCK

NEW PRODUCT



Concrete sprinkler cup to embed
 Instort sprinklercup in beton
 Connexion sprinkler à encastrer en béton
 Sprinkler-Anschluss im Beton zum Eingiessen

Article number	Box	Type
SPR-CBLOCK	18 pc.	Height = 65 mm
SPR-CBLOCK80	16 pc.	Height = 80 mm

Type: SPR-CBLOCK-WS

NEW PRODUCT



Concrete sprinkler cup to embed with insulation for wide slabs
 Instort sprinklercup in beton met isolatie voor breedplaten
 Connexion sprinkler à encastrer en béton avec isolation pour dalles alvéolées
 Sprinkler-Anschluss im Beton zum Eingiessen mit Isolierung für Plattendecke

Article number	Box	Type
SPR-CBLOCK80-WS	16 pc.	Height = 80 mm

Type: SPR-CBLOCK-TF

NEW PRODUCT



Concrete sprinkler cup to embed with glue fixation for tunnel formwork
 Instort sprinklercup in beton met lijmfixatie voor tunnelbouw
 Connexion sprinkler à encastrer en béton avec fixation à coller pour coffrage de tunnel
 Concrete sprinkler cup to embed with glue fixation for tunnel formwork

Article number	Box	Type
SPR-CBLOCK-TF	18 pc.	Height = 65 mm

Type: SPR-ISO-WS

NEW PRODUCT

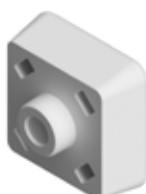

Insulation for concrete sprinkler cup to embed for wide slabs
 Isolatie voor instort sprinklercup in beton voor breedplaten
 Isolation pour connexion sprinkler à encastrer en béton pour dalles alvéolées
 Isolierung für Sprinkler-Anschluss im Beton zum Eingiessen für Plattendecke

Article number	Bag / Box	Type
SPR-ISO-WS	9 pc. / 45 pc.	EPS



Type: SPR-MAGNET

NEW PRODUCT



Magnet fixation
Magneetfixatie
Magnet fixation
Magnet Fixierung

Article number	Box	Type
SPR-MAGNET26	720 pc.	Height = 26 mm
SPR-MAGNET31	400 pc.	Height = 31 mm

Type: SPR-ISO-MAGNET

NEW PRODUCT

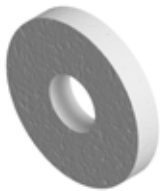

Insulation for magnet
Isolatie voor magneet
Isolation pour magnet
Isolierung für Magnet

Article number	Box	Type
SPR-ISO-MAGNET26	480 pc.	PE

Type: SPR-FIX

NEW PRODUCT



Fixation for concrete sprinkler cup to embed
Fixatie voor instort sprinklercup in beton
Fixation pour connexion sprinkler à encastrer en béton
Fixierung für Sprinkler-Anschluss im Beton zum Eingiessen

Article number	Bag / Box	Type
SPR-FIXSCREW	60 pc. / 360	SCREW FIXATION
SPR-FIXGLUE	60 pc. / 360	GLUE FIXATION

Type: SPR-ISO

NEW PRODUCT

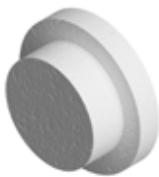

Insulation for glue and screw fixation
Isolatie voor lijm- en schroeffixatie
Isolation pour fixation à coller et à visser.
Isolierung für Fixierung zum Schrauben und Kleben

Article number	Bag	Type
SPR-ISO	60 pc.	PE

- 1
- 2
- 3
- 4
- 5
- 6
- 7
- 8
- 9
- 10
- 11
- 12



Henco Sprinkler

Henco PRO-Sprinkler



Type: SPR-N0604



Reduction 1" M- 1/2" F;
different built-in depths for SPR-CBLOCK (L) and SPR-CBLOCK-WS (H)

Reductie 1" BuDr-1/2" BiDr;
verschillende inbouwdieptes SPR-CBLOCK (L) en SPR-CBLOCK-WS (H)

Réduction 1" F-1/2" M;
différentes profondeurs d'installation SPR-CBLOCK (L) et SPR-CBLOCK-WS (H)

Reduktion 1" IG-1/2" AG;
unterschiedliche Einbautiefen SPR-CBLOCK (L) und SPR-CBLOCK-WS (H)

Article number	Box	Built-in depth sprinkler*
SPR-N0604IDLXXH00	56 pc.	L: --mm - H: 00mm
SPR-N0604IDLXXH05	60 pc.	L: --mm - H: 05mm
SPR-N0604IDLXXH10	63 pc.	L: --mm - H: 10mm
SPR-N0604IDL00H15	36 pc.	L: 00mm - H: 15mm
SPR-N0604IDL05H20	72 pc.	L: 05mm - H: 20mm
SPR-N0604IDL10H25	72 pc.	L: 10mm - H: 25mm
SPR-N0604IDL15H30	72 pc.	L: 15mm - H: 30mm
SPR-N0604IDL20H35	72 pc.	L: 20mm - H: 35mm
SPR-N0604IDL25H40	72 pc.	L: 25mm - H: 40mm
SPR-N0604IDL30H45	108 pc.	L: 30mm - H: 45mm

*L: built-in depth for SPR-CBLOCK
H: built-in depth for SPR-CBLOCK-80-WS



Type: SPR-PLUGTOOL

NEW*
PRODUCT



Tool to remove pressure test plug and mount reducer
Tool voor verwijderen afpersplug en monteren verloopnippel
Outil pour retirer bouchon et monter réduction
Werkzeug zum Entfernen des Presseteststopfen und montieren Reduktion

Article number	Bag	Type
SPR-PLUGTOOL	10 pc.	Plugtool

Type: SPR-PULLTOOL

NEW*
PRODUCT



Tool to remove fixation element
Tool voor verwijderen fixatie element
Outil pour retirer élément de fixation
Werkzeug zum Entfernen des Fixierungselements

Article number	Box	Type
SPR-PULLTOOL	1 pc.	Pulltool

1

2

3

4

5

6

7

8

9

10

11

12

CERTIFICATES - CERTIFICATEN - APPROBATIONS - ZERTIFIKATE





GERMANY



AUSTRIA



FRANCE



THE NETHERLANDS



POLAND



DENMARK



ITALY



RUSSIA



SLOVAKIA



ATG SYSTEM CERTIFICATE BELGIUM



NORWAY



FINLAND



HUNGARY



ENGLAND



SWEDEN



USA



ESTONIA



SPAIN



CZECH REPUBLIC



SOUTH AFRICA

INDEX

Article number	Page	Article number	Page	Article number	Page	Article number	Page
1-1403C-S	94	1PKW-3232	38	2PKW-2004-N	38	3SK-160416BP	66
1-1604-S	94	1SK-1616	66	2PKW-2004-X	38	3SK-200420BP	66
1-1804-S	94	1SK-2020	66	2PKW-2005	38	4-1616-S	94
1-1805	94	1SK-2626	66	2PKW-2005-N	38	4-2020-S	94
1-2004-S	94	2-1616-S	94	2PKW-2005-X	38	4-2626-S	94
1-2004-ZS	94	2-2020-S	94	2PKW-2605	38	04-160212	8
1-2005-S	94	2C-0404	99	2PKW-2605-N	38	04-200216	8
1-2605-S	94	2P-1404K	74	2PKW-2605-X	38	04-260320	8
1-2606-S	94	2P-1604	74	2S-1604K	66	04-320326	8
1-3206-S	94	2P-1604K	74	2SK-1604BP	66	04-403533	8
1-FLEX32	13	2P-1804	74	2SK-2004BP	66	04-504042	8
1HNA	56	2P-2004	74	2SK-2005	66	04-634554	8
1HNB	56	2P-2005	74	2SK-2605	66	4P-1604	75
1P-1616	74	2P-2605	74	3-1604-S	94	04-R160212	14
1P-1818	74	2PG-1604	88	3-1804-S	94	04-R200216	14
1P-2020	74	2PG-1604K	88	3-2004-S	94	04-R260320	14
1P-2626	74	2PG-2004	88	3-2005-S	94	5-1604-S	95
1P-3232	74	2PG-2005	88	3-2605-S	94	5-1804	95
1PG-1616	88	2PG-2605	88	3-2606-S	94	5-2005-S	95
1PG-2020	88	2PK-1404BP	26	03-160212	8	5-2606-S	95
1PG-2626	88	2PK-1404-X	26	03-180214	8	05-160212	8
1PG-3232	88	2PK-1603	26	03-200216	8	05-160212-GAS	23
1PK-20JG10	26	2PK-1604BP	26	03-260320	8	05-180214	8
1PK-1414	26	2PK-1604KBP	27	03-320326	8	05-200216	8
1PK-1616	26	2PK-1604-X	26	03-403533	8	05-200216-GAS	23
1PK-1818	26	2PK-1804BP	26	03-504042	8	05-260320	8
1PK-2020	26	2PK-1804-X	26	03-634554	8	05-260320-GAS	23
1PK-2626	26	2PK-2004BP	26	3EK-050405	98	05-320326	8
1PK-3232	26	2PK-2004-X	26	3P-160416	74	05-320326-GAS	23
1PK-4040	26	2PK-2005	26	3P-160416VK	74	05-320326-SPR	24
1PK-5050	26	2PK-2005-X	26	3P-200420	74	05-320326-SPR	164
1PK-6363	26	2PK-2605	26	3P-200420VK	74	05-403533	8
1PK-7575	60	2PK-2605-X	26	3P-260426VK	74	05-403533-GAS	23
1PK-9090	60	2PKG-1603	48	3PK-160416BP	27	05-403533-SPR	24
1PKG-1616	48	2PKG-1604BP	48	3PK-160416-X	27	05-403533-SPR	164
1PKG-2020	48	2PKG-1604KBP	48	3PK-200420BP	27	05-504042	8
1PKG-2626	48	2PKG-2004BP	48	3PK-200420-X	27	05-504042-SPR	24
1PKG-3232	48	2PKG-2005	48	3PKW-160416	39	05-504042-SPR	164
1PKG-4040	48	2PKG-2605	48	3PKW-160416-N	40	05-634554	8
1PKS-3232	165	2PKW-1604	38	3PKW-160416-X	40	05-634554-SPR	24
1PKS-4040	165	2PKW-1604K	39	3PKW-200420	39	05-634554-SPR	164
1PKS-5050	165	2PKW-1604K-N	39	3PKW-200420-N	40	05-756063	8
1PKS-6363	165	2PKW-1604K-X	39	3PKW-200420-X	40	05-907076	8
1PKW-1616	38	2PKW-1604-N	38	03-R160212	14	5P-1603	75
1PKW-2020	38	2PKW-1604-X	38	03-R200216	14	5P-1603DZR	75
1PKW-2626	38	2PKW-2004	38	03-R260320	14	5P-1604	75

Article number	Page	Article number	Page	Article number	Page	Article number	Page
5P-1604DZR	75	5PKW-2004	40	6PK-5007	28	6PKW-2004-X	41
5P-1804	75	5PKW-2004-N	40	6PK-5007-N	29	6PKW-2005	40
5P-2004	75	5PKW-2005	40	6PK-5007-X	29	6PKW-2005-N	41
5P-2005	75	5PKW-2005-N	40	6PK-5008	28	6PKW-2005-X	41
5P-2605	75	5PKW-2605	40	6PK-5008-N	29	6PKW-2605	40
5P-3206	75	5PKW-2605-N	40	6PK-5008-X	29	6PKW-2605-N	41
5P-2606	75	5PKW-3206	40	6PK-6310	28	6PKW-2605-X	41
5PG-1604	89	5PKW-3206-N	40	6PK-6310-N	29	6PKW-3206	40
5PG-2004	89	05-R160212	14	6PK-6310-X	29	6PKW-3206-N	41
5PG-2005	89	05-R200216	14	6PK-7506	60	6PKW-3206-X	41
5PG-2605	89	05-R260320	14	6PK-7510	60	6SK-1604BP	67
5PK-1404	28	5SK-1604	67	6PK-7512	60	6SK-2004BP	67
5PK-1604	28	5SK-2004	67	6PK-9014	60	6SK-2005	67
5PK-1804	28	5SK-2005	67	6PKG-1604BP	49	6SK-2605	67
5PK-2004	28	5SK-2605	67	6PKG-2004BP	49	6VBS-2005	107
5PK-2005	28	6-1604-S	95	6PKG-2005	49	6VBS-2605	107
5PK-2605	28	6-1804	95	6PKG-2605	49	7-1604-S	95
5PK-3206	28	6-2004-S	95	6PKG-3206	49	7P-1605	76
5PK-4007	28	6-2005-S	95	6PKG-4007	49	7P-1605K	76
5PK-4007-N	28	6P-1604	75	6PKS-3204	165	7P-1605L	76
5PK-5007	28	6P-1804	75	6PKS-3204-N	166	8-161616-S	95
5PK-5007-N	28	6P-2004	75	6PKS-3206	165	8HNA-PK...	64
5PK-5008	28	6P-2005	75	6PKS-3206-N	166	8HNA-PK32	56
5PK-5008-N	28	6P-2605	75	6PKS-3206OP	171	8HNA-PK40	56
5PK-6310	28	6PG-1604	89	6PKS-3206OP-CS	171	8HNA-PK50	56
5PK-6310-N	28	6PG-2004	89	6PKS-4004	165	8HNA-PK63	56
5PK-7510	60	6PG-2005	89	6PKS-4004-N	166	8HNA-PK75	56
5PK-7512	60	6PG-2605	89	6PKS-4007	165	8HNB-PK90	56
5PKG-1604	48	6PK-1404BP	28	6PKS-4007-N	166	8P-1604	76
5PKG-2004	48	6PK-1404-X	29	6PKS-5004	165	9HNA	56
5PKG-2005	48	6PK-1603	28	6PKS-5004-N	166	9HNB	56
5PKG-2605	48	6PK-1604BP	28	6PKS-5007	165	9P-161616	76
5PKG-3206	48	6PK-1604-X	29	6PKS-5007-N	166	9P-181818	76
5PKG-4007	48	6PK-1804BP	28	6PKS-5008	165	9P-202020	76
5PKS-3206	165	6PK-1804-X	29	6PKS-5008-N	166	9P-262626	76
5PKS-3206-N	165	6PK-2004BP	28	6PKS-6304	165	9PG-161616	89
5PKS-4007	165	6PK-2004-X	29	6PKS-6304-N	166	9PG-202020	89
5PKS-4007-N	165	6PK-2005	28	6PKS-6310	165	9PG-262626	89
5PKS-5007	165	6PK-2005-X	29	6PKS-6310-N	166	9PG-323232	89
5PKS-5007-N	165	6PK-2605	28	6PKW-1603	40	9PK-141414	29
5PKS-5008	165	6PK-2605-X	29	6PKW-1603-N	41	9PK-161616	29
5PKS-5008-N	165	6PK-3206	28	6PKW-1604	40	9PK-181818	29
5PKS-6310	165	6PK-3206-X	29	6PKW-1604-N	41	9PK-202020	29
5PKS-6310-N	165	6PK-4007	28	6PKW-1604-X	41	9PK-262626	29
5PKW-1604	40	6PK-4007-N	29	6PKW-2004	40	9PK-323232	29
5PKW-1604-N	40	6PK-4007-X	29	6PKW-2004-N	41	9PK-404040	29

INDEX

Article number	Page	Article number	Page	Article number	Page	Article number	Page
9PK-505050	29	10PK-402640	30	11P-201616	76	11PK-904040	61
9PK-636363	29	10PK-403240	30	11P-202016	76	11PK-904050	61
9PK-757575	60	10PK-502050	30	11P-261620	76	11PK-904063	61
9PK-909090	60	10PK-502650	30	11P-262020	76	11PK-904075	61
9PKG-161616	49	10PK-503250	30	11P-262616	76	11PK-905050	61
9PKG-202020	49	10PK-504050	30	11P-262620	76	11PK-905063	61
9PKG-262626	49	10PK-632663	30	11P-322026	76	11PK-905075	61
9PKG-323232	49	10PK-633263	30	11P-322626	76	11PK-906363	61
9PKG-404040	49	10PK-634063	30	11PG-201616	90	11PK-906375	61
9PKS-323232	166	10PK-635063	30	11PK-161414	31	11PK-907575	61
9PKS-404040	166	10PK-753275	61	11PK-181616	31	11PKG-201616	50
9PKS-505050	166	10PK-754075	61	11PK-201616	31	11PKG-202016	50
9PKS-636363	166	10PK-755075	61	11PK-201818	31	11PKG-261620	50
9PKW-161616	41	10PK-756375	61	11PK-202016	31	11PKG-262016	50
9PKW-202020	41	10PK-903290	61	11PK-261616	31	11PKG-262020	50
9PKW-262626	41	10PK-904090	61	11PK-261620	31	11PKG-262616	50
9PKW-323232	41	10PK-905090	61	11PK-262016	31	11PKG-262620	50
9SK-161616	67	10PK-906390	61	11PK-262020	31	11PKG-322026	50
9SK-202020	67	10PK-907590	61	11PK-262616	31	11PKG-322626	50
9SK-262626	67	10PKG-201620	49	11PK-262620	31	11PKG-402032	50
10-1604SN	95	10PKG-261626	49	11PK-322026	31	11PKG-402632	50
10-160212-KB	7	10PKG-262026	49	11PK-322626	31	11PKG-403232	50
10P-181618	76	10PKG-321632	49	11PK-402032	31	11PKG-404026	50
10P-201620	76	10PKG-322032	49	11PK-402632	31	11PKG-404032	50
10P-261626	76	10PKG-322632	49	11PK-403232	31	11PKS-403232	166
10P-262026	76	10PKG-401640	49	11PK-404026	31	11PKS-404032	166
10P-321632	76	10PKG-402040	49	11PK-404032	31	11PKS-503240	166
10P-322032	76	10PKG-402640	49	11PK-502040	31	11PKS-504040	166
10PG-201620	90	10PKG-403240	49	11PK-502640	31	11PKW-201616	42
10PG-262026	90	10PKS-403240	166	11PK-503240	31	11PKW-202016	42
10PK-20JG1020	30	10PKS-503250	166	11PK-504040	31	11PKW-261616	42
10PK-161416	30	10PKS-504050	166	11PK-753232	61	11PKW-261620	42
10PK-181418	30	10PKS-633263	166	11PK-753240	61	11PKW-262016	42
10PK-181618	30	10PKS-634063	166	11PK-753250	61	11PKW-262020	42
10PK-201420	30	10PKS-635063	166	11PK-753263	61	11PKW-262616	42
10PK-201620	30	10PKW-201620	41	11PK-754040	61	11PKW-262620	42
10PK-201820	30	10PKW-261626	41	11PK-754050	61	11PKW-322026	42
10PK-261626	30	10PKW-262026	41	11PK-754063	61	11PKW-322626	42
10PK-261826	30	10PKW-321632	41	11PK-755050	61	11SK-201616	68
10PK-262026	30	10PKW-322032	41	11PK-755063	61	11SK-202016	68
10PK-321632	30	10PKW-322632	41	11PK-756363	61	11SK-261620	68
10PK-321832	30	10-R160212-KB	14	11PK-903232	61	11SK-262016	68
10PK-322032	30	10-R200216-KB	14	11PK-903240	61	11SK-262020	68
10PK-322632	30	10SK-201620	67	11PK-903250	61	11SK-262616	68
10PK-401640	30	10SK-261626	67	11PK-903263	61	11SK-262620	68
10PK-402040	30	10SK-262026	67	11PK-903275	61	12P-162016	77

Article number	Page	Article number	Page	Article number	Page	Article number	Page
12P-202620	77	13PK-200520	32	13PKG-400740	50	13PKW-320632-X	43
12PK-161816	31	13PK-200520-X	32	13PKS-320432	167	13SK-160416BP	68
12PK-162016	31	13PK-260420BP	32	13PKS-320432-N	167	13SK-200420BP	68
12PK-202620	31	13PK-260420-X	32	13PKS-320532	167	13SK-200520	68
12PK-263226	31	13PK-260426BP	32	13PKS-320532-N	167	13SK-260420BP	68
12PK-324032	31	13PK-260426-X	32	13PKS-320632	167	13SK-260426BP	68
12PK-327532	62	13PK-260526	32	13PKS-320632-N	167	13SK-260526	68
12PK-329032	62	13PK-260526-X	32	13PKS-320632OP	171	13-V2622H-2	96
12PK-405040	31	13PK-320532	32	13PKS-320632OP-CS	171	14P-160416	77
12PK-407540	62	13PK-320532-X	32	13PKS-320732	167	14P-200420	77
12PK-409040	62	13PK-320632	32	13PKS-320732-N	167	14P-200520	77
12PK-507550	62	13PK-320632-X	32	13PKS-400440	167	14P-260426	77
12PK-509050	62	13PK-320732	32	13PKS-400440-N	167	14PK-160416	33
12PK-637563	62	13PK-320732-X	32	13PKS-400640	167	14PK-180418	33
12PK-639063	62	13PK-400540	32	13PKS-400640-N	167	14PK-200420	33
12PK-759075	62	13PK-400540-N	32	13PKS-400740	167	14PK-200520	33
12PKG-162016	50	13PK-400540-X	32	13PKS-400740-N	167	14PK-260426	33
12PKG-202620	50	13PK-400640	32	13PKS-500450	167	14PK-260526	33
12PKG-263226	50	13PK-400640-N	32	13PKS-500550	167	14PK-260626	33
12PKG-324032	50	13PK-400640-X	32	13PKS-500550-N	167	14PK-320532	33
12PKS-324032	167	13PK-400740	32	13PKS-500850	167	14PK-400640	33
12PKS-405040	167	13PK-400740-N	32	13PKS-500850-N	167	14PK-400640-N	33
12PKW-162016	42	13PK-400740-X	32	13PKS-630463	167	14PK-400740	33
12PKW-202620	42	13PK-500550	32	13PKS-630463-N	167	14PK-400740-N	33
12PKW-263226	42	13PK-500550-N	32	13PKS-631063	167	14PK-500850	33
12SK-162016	68	13PK-500550-X	32	13PKS-631063-N	167	14PK-500850-N	33
12SK-202620	68	13PK-500850	32	13PKW-160416	42	14PK-631063	33
13-1415-2	96	13PK-500850-N	32	13PKW-160416-N	43	14PK-631063-N	33
13-1615A-2	96	13PK-500850-X	32	13PKW-160416-X	43	14PK-751075	62
13-1615HA-2	96	13PK-631063	32	13PKW-200420	42	14PK-751275	62
13-2022HA-2	96	13PK-631063-N	32	13PKW-200420-N	43	14PKG-160416	51
13-2628H-2	96	13PK-631063-X	32	13PKW-200420-X	43	14PKG-200420	51
13P-160416	77	13PK-750675	62	13PKW-200520	42	14PKG-260426	51
13P-200420	77	13PK-751075	62	13PKW-200520-N	43	14PKG-260626	51
13P-200520	77	13PK-751275	62	13PKW-200520-X	43	14PKS-320532	168
13P-260426	77	13PK-901490	62	13PKW-260426	42	14PKS-320532-N	168
13P-260526	77	13PKG-160416BP	50	13PKW-260426-N	43	14PKS-400640	168
13P-320532	77	13PKG-200420BP	50	13PKW-260426-X	43	14PKS-400640-N	168
13PG-200420	90	13PKG-200520	50	13PKW-260526	42	14PKS-400740	168
13PG-260426	90	13PKG-260420BP	50	13PKW-260526-N	43	14PKS-400740-N	168
13PK-160416BP	32	13PKG-260426BP	50	13PKW-260526-X	43	14PKS-500850	168
13PK-160416-X	32	13PKG-260526	50	13PKW-320532	42	14PKS-500850-N	168
13PK-180418BP	32	13PKG-320532	50	13PKW-320532-N	43	14PKS-631063	168
13PK-180418-X	32	13PKG-320632	50	13PKW-320532-X	43	14PKS-631063-N	168
13PK-200420BP	32	13PKG-320732	50	13PKW-320632	42	14PKW-160416	44
13PK-200420-X	32	13PKG-400640	50	13PKW-320632-N	43	14PKW-160416-N	44

INDEX

Article number	Page	Article number	Page	Article number	Page	Article number	Page
14PKW-200420	44	16P-1816	78	16PKS-4032	168	17PG-3206	91
14PKW-200420-N	44	16P-2016	78	16PKS-5032	168	17PK-1404	34
14PKW-200520	44	16P-2018	78	16PKS-5040	168	17PK-1604	34
14PKW-200520-N	44	16P-2616	78	16PKS-6340	168	17PK-1804	34
14PKW-320532	44	16P-2620	78	16PKS-6350	168	17PK-1805	34
14SK-160416	68	16P-3216	78	16PKW-2016	45	17PK-2004	34
14SK-200420	68	16P-3220	78	16PKW-2616	45	17PK-2005	34
14SK-260426	68	16P-3226	78	16PKW-2620	45	17PK-2605	34
15P-1616	77	16PG-2016	91	16PKW-3216	45	17PK-2606	34
15P-1818	77	16PG-2620	91	16PKW-3220	45	17PK-3206	34
15P-2020	77	16PG-3226	91	16PKW-3226	45	17PK-3207	34
15P-2626	77	16PK-1614	34	16SK-2016	69	17PK-4006	34
15P-3232	77	16PK-1814	34	16SK-2616	69	17PK-4006-N	34
15PG-1616	91	16PK-1816	34	16SK-2620	69	17PK-4007	34
15PG-2020	91	16PK-2014	34	17HNA-06-X	57	17PK-4007-N	34
15PG-2626	91	16PK-2016	34	17HNA-07-X	57	17PK-5008	34
15PG-3232	91	16PK-2018	34	17HNA-08-X	57	17PK-5008-N	34
15PK-1414	33	16PK-2616	34	17HNA-10	57	17PK-6310	34
15PK-1616	33	16PK-2618	34	17HNA-10-N	57	17PK-6310-N	34
15PK-1818	33	16PK-2620	34	17HNA-10-X	57	17PK-7510	63
15PK-2020	33	16PK-3216	34	17HNA-12	57	17PK-7512	63
15PK-2626	33	16PK-3220	34	17HNA-12-N	57	17PKG-1604	52
15PK-3232	33	16PK-3226	34	17HNA-12-X	57	17PKG-2004	52
15PK-4040	33	16PK-4026	34	17P-1603	78	17PKG-2005	52
15PK-5050	33	16PK-4032	34	17P-1603DZR	78	17PKG-2605	52
15PK-6363	33	16PK-5032	34	17P-1604	78	17PKG-2606	52
15PK-7575	62	16PK-5040	34	17P-1604-CS	78	17PKG-3206	52
15PK-9090	62	16PK-6340	34	17P-1604DZR	78	17PKG-3207	52
15PKG-1616	51	16PK-6350	34	17P-1605	78	17PKG-4006	52
15PKG-2020	51	16PK-7532	63	17P-1804	78	17PKG-4007	52
15PKG-2626	51	16PK-7540	63	17P-1805	78	17PKS-3206	169
15PKG-3232	51	16PK-7550	63	17P-2004	78	17PKS-3206-N	169
15PKG-4040	51	16PK-7563	63	17P-2004-CS	78	17PKS-3207	169
15PKS-3232	168	16PK-9032	63	17P-2005	78	17PKS-3207-N	169
15PKS-4040	168	16PK-9040	63	17P-2005-CS	78	17PKS-4006	169
15PKS-5050	168	16PK-9050	63	17P-2605	78	17PKS-4006-N	169
15PKS-6363	168	16PK-9063	63	17P-2605-CS	78	17PKS-4007	169
15PKW-1616	44	16PK-9075	63	17P-2606	78	17PKS-4007-N	169
15PKW-2020	44	16PKG-2016	51	17P-2606-CS	78	17PKS-5008	169
15PKW-2626	44	16PKG-2616	51	17P-3206	78	17PKS-5008-N	169
15PKW-3232	44	16PKG-2620	51	17P-3207	78	17PKS-6310	169
15-R160212-KB	14	16PKG-3216	51	17PG-1604	91	17PKS-6310-N	169
15SK-1616	69	16PKG-3220	51	17PG-2004	91	17PKW-1604	45
15SK-2020	69	16PKG-3226	51	17PG-2005	91	17PKW-1604-N	45
15SK-2626	69	16PKG-4026	51	17PG-2605	91	17PKW-2004	45
16HNBA	56	16PKG-4032	51	17PG-2606	91	17PKW-2004-N	45

Article number	Page	Article number	Page	Article number	Page	Article number	Page
17PKW-2005	45	18P-3206	79	18PKG-2605	52	18SK-2605	69
17PKW-2005-N	45	18P-3207	79	18PKG-2606	52	18SK-2606	69
17PKW-2605	45	18PG-1604	92	18PKG-3206	52	18SKS-2004	70
17PKW-2605-N	45	18PG-2004	92	18PKG-3207	52	18SKS-2004	102
17PKW-2606	45	18PG-2005	92	18PKG-4006	52	18SKS-2005	70
17PKW-2606-N	45	18PG-2605	92	18PKG-4007	52	18SKS-2005	102
17PKW-3206	45	18PG-2606	92	18PKS-3204	169	18SKS-2604	70
17PKW-3206-N	45	18PG-3206	92	18PKS-3204-N	169	18SKS-2604	102
17PKW-3207	45	18PK-1404	35	18PKS-3206	169	18SKS-2605	70
17PKW-3207-N	45	18PK-1604	35	18PKS-3206-N	169	18SKS-2605	102
17SK-1603	69	18PK-1604-X	35	18PKS-3206OP	171	19P-1405	79
17SK-1604	69	18PK-1804	35	18PKS-3206OP-CS	171	19P-1605	64
17SK-2004	69	18PK-1804-X	35	18PKS-3207	169	19P-1605	79
17SK-2005	69	18PK-1805	35	18PKS-3207-N	169	19P-1805	79
17SK-2605	69	18PK-1805-X	35	18PKS-4006	169	19P-2005	64
17SK-2606	69	18PK-2004	35	18PKS-4006-N	169	19P-2005	79
17SKS-2004	70	18PK-2004-X	35	18PKS-4007	169	19PK-1605	36
17SKS-2004	102	18PK-2005	35	18PKS-4007-N	169	19PK-1605	64
17SKS-2005	70	18PK-2005-X	35	18PKS-5008	169	19PK-2005	36
17SKS-2005	102	18PK-2605	35	18PKS-5008-N	169	19PK-2005	64
17SKS-2604	70	18PK-2605-X	35	18PKS-6310	169	19PKW-1605	47
17SKS-2604	102	18PK-2606	35	18PKS-6310-N	169	19PKW-2005	47
17SKS-2605	70	18PK-2606-X	35	18PKW-1604	46	19SK-1505	70
17SKS-2605	102	18PK-3206	35	18PKW-1604-N	46	19SK-1505	101
17VBS-2005	107	18PK-3206-X	35	18PKW-1604-X	46	19SK-1605	64
17VBS-2605	107	18PK-3207	35	18PKW-2004	46	19SK-1605	70
17VBS-2606	107	18PK-3207-X	35	18PKW-2004-N	46	19SK-1605	101
18EK05	103	18PK-4006	35	18PKW-2004-X	46	19SK-2005	64
18HNA-06	58	18PK-4006-N	36	18PKW-2005	46	19SK-2005	70
18HNA-06-N	58	18PK-4006-X	35	18PKW-2005-N	46	19SK-2005	101
18HNA-06-X	58	18PK-4007	35	18PKW-2005-X	46	24-1615-S	96
18HNA-08-X	58	18PK-4007-N	36	18PKW-2605	46	24-2022	96
18HNA-10	58	18PK-4007-X	35	18PKW-2605-N	46	24-2622	96
18HNA-10-N	58	18PK-5008	35	18PKW-2605-X	46	24P-1604	79
18HNA-10-X	58	18PK-5008-N	36	18PKW-2606	46	24P-2004	79
18HNA-12	58	18PK-5008-X	35	18PKW-2606-N	46	25-016GASMG	23
18HNA-12-N	58	18PK-6310	35	18PKW-2606-X	46	25-016MB	12
18HNA-12-X	58	18PK-6310-N	36	18PKW-3206	46	25-016MB-KB	13
18HNB-14	58	18PK-6310-X	35	18PKW-3206-N	46	25-016MR	12
18HNB-14-N	58	18PK-7506	63	18PKW-3206-X	46	25-016MR-KB	13
18P-1604	79	18PK-7510	63	18PKW-3207	46	25-020GASMG	23
18P-1804	79	18PK-7512	63	18PKW-3207-N	46	25-020MB	12
18P-2004	79	18PK-9014	63	18PKW-3207-X	46	25-020MBLACK	12
18P-2005	79	18PKG-1604	52	18SK-1604	69	25-020MR	12
18P-2605	79	18PKG-2004	52	18SK-2004	69	25-026GASMG	23
18P-2606	79	18PKG-2005	52	18SK-2005	69	25-026MB	12

INDEX

Article number	Page	Article number	Page	Article number	Page	Article number	Page
25-026MR	12	25P-1604	79	27P-3232	81	35P-1615P	83
25-032GASMG	23	25-R16MB	18	27PK-2626	37	35P-2022P	83
25-032MB	12	25-R16MR	18	27PK-3232	37	36P-1612P	84
25-032MR	12	25-R20MB	18	27PK-4040	37	36P-1614P	84
25-160212-KB	7	25-R20MBLACK	18	27PK-5050	37	36P-1615P	84
25-200216	7	25-R20MR	18	27PK-6363	37	36P-1616P	84
25-200216-KB	7	25-R160212-KB	14	27PK-7575	63	36P-2015P	84
25-ISO4-26-BL	8	25-R200216-KB	14	27PK-9090	63	36P-2018P	84
25-ISO4-26-BL-BSD	9	25-R260320	14	27PKG-4040	52	36P-2022P	84
25-ISO4-26-RO	8	26P-16Z03	80	27PKS-3232	170	36P-2622P	84
25-ISO4-26-RO-BSD	9	26P-16Z04	80	27PKS-4040	170	36P-2628P	84
25-ISO4-32-BL	8	26P-16Z04DZR	80	27PKS-5050	170	36P-3228P	84
25-ISO4-32-BL-BSD	9	26P-16Z05	80	27PKS-6363	170	36PG-1615P	92
25-ISO4-32-RO	8	26P-20Z04	80	27PKW-2626	47	36PG-2015P	92
25-ISO4-32-RO-BSD	9	26P-20Z04DZR	80	27PKW-3232	47	36PG-2022P	92
25-ISO4-R16-BL-BSD	15	26P-20Z05	80	28P-14041604-1	81	36PG-2615P	92
25-ISO4-R16-RO-BSD	15	26P-20Z05DZR	80	28P-16041604-1	81	36PG-2622P	92
25-ISO4-R26-BL	15	26P-26Z05	80	28PF-16041604	81	37P-1412L	84
25-ISO4-R26-BL-BSD	15	26P-26Z05DZR	80	28PF-20042004	81	37P-1612L	84
25-ISO4-R26-RO	15	26P-26Z06	80	28PK-04	37	37P-1615L	84
25-ISO4-R26-RO-BSD	15	26P-32Z06	80	28PV-16031603-1	81	39P-160450	84
25-ISO9-26-BL	10	26P-32Z07	80	28PV-16041604-1	81	40P-1615S	84
25-ISO9-26-BL-BSD	10	26P-1604	80	29P-1612-CS	82	40P-2022S	84
25-ISO9-26-RO	10	26P-1605	80	29P-1615-CS	82	40P-2622S	84
25-ISO9-26-RO-BSD	10	26P-2004	80	29P-2018-CS	82	41P-16	85
25-ISO9-32-BL	10	26P-2005	80	29P-2022-CS	82	41P-20	85
25-ISO9-32-BL-BSD	10	26P-2605	80	29P-2622-CS	82	41P-26	85
25-ISO9-32-RO	10	26P-2606	80	30P-1614S	82	41S-20	112
25-ISO9-32-RO-BSD	10	26P-3206	80	30P-1615S-2	82	41S-26	112
25-ISO9-R26-BL	16	26PK-1605	36	30P-2022S	82	41SKS-20	112
25-ISO9-R26-BL-BSD	16	26PK-2005	36	30P-2622S	82	41SKS-26	112
25-ISO9-R26-RO	16	26PK-4007	36	30PG-1615S-2	92	42P-161615	85
25-ISO9-R26-RO-BSD	16	26PK-4008	36	30PG-2022S	92	42P-202019	85
25-ISO13-32-BL	10	26PK-5008	36	30PG-2622S	92	43P-161516	85
25-ISO13-32-BL-BSD	11	26PK-5010	36	31P-161616	82	44P-1604	86
25-ISO13-32-RO	10	26PK-6310	36	31P-201616	82	45P-1604	86
25-ISO13-32-RO-BSD	11	26PK-6312	36	31P-201620	82	50-014MB	12
25-ISO20-32-BL-BSD	11	26PKW-1605	47	31P-202020	82	50-014MR	12
25-ISO20-32-RO-BSD	11	26PKW-2005	47	33P-1605	64	50-016GASMG	23
25-ISO20-R26-BL	17	26SK-1605	70	33P-1605	83	50-016MB	12
25-ISO20-R26-BL-BSD	17	26SK-1605	102	34P-1604	83	50-016MBLACK	12
25-ISO20-R26-RO	17	26SK-2005	70	34P-1605-CS	83	50-016MR	12
25-ISO20-R26-RO-BSD	17	26SK-2005	102	34P-2004-CS	83	50-018MB	12
25-MB32	22	27HNA	56	34P-2005-CS	83	50-018MR	12
25-MG32	22	27HNB	56	34P-2605-CS	83	50-020GASMG	23
25-MR32	22	27P-2626	81	34P-3206	83	50-020MB	12

Article number	Page	Article number	Page	Article number	Page	Article number	Page
50-020MBLACK	12	50-ISO4-R20-BL-BSD	15	50-ISO13-16-RO-BSD	11	50-R16MB	18
50-020MR	12	50-ISO4-R20-RO	15	50-ISO13-18-BL	10	50-R16MBLACK	18
50-026GASMG	23	50-ISO4-R20-RO-BSD	15	50-ISO13-18-BL-BSD	11	50-R16MR	18
50-026MB	12	50-ISO4-R26-BL	15	50-ISO13-18-RO-BSD	11	50-R18MB	18
50-026MBLACK	12	50-ISO4-R26-BL-BSD	15	50-ISO13-20-BL	10	50-R18MR	18
50-026MR	12	50-ISO4-R26-RO	15	50-ISO13-20-BL-BSD	11	50-R20MB	18
50-160212	7	50-ISO4-R26-RO-BSD	15	50-ISO13-20-RO	10	50-R20MR	18
50-200216	7	50-ISO9-14-BL	9	50-ISO13-20-RO-BSD	11	50-R26MB	18
50-260320	7	50-ISO9-14-BL-BSD	10	50-ISO13-26-BL	10	50-R26MR	18
50-260320-GAS	23	50-ISO9-14-RO	9	50-ISO13-26-BL-BSD	11	50-R160212	14
50-320326	7	50-ISO9-14-RO-BSD	10	50-ISO13-26-RO	10	50-R200216	14
50-320326-GAS	23	50-ISO9-16-BL	9	50-ISO13-26-RO-BSD	11	50-R260320	14
50-320326-SPR	24	50-ISO9-16-BL-BSD	10	50-ISO13-R16-BL	16	52P16	86
50-320326-SPR	164	50-ISO9-16-RO	9	50-ISO13-R16-BL-BSD	17	52P20	86
50-COMBI16	12	50-ISO9-16-RO-BSD	10	50-ISO13-R16-RO	16	52P26	86
50-COMBI16R	18	50-ISO9-18-BL	9	50-ISO13-R16-RO-BSD	17	52P32	86
50-ISO4-16-BL	8	50-ISO9-18-BL-BSD	10	50-ISO13-R20-BL	16	52PS32	170
50-ISO4-16-BL-BSD	9	50-ISO9-18-RO	9	50-ISO13-R20-BL-BSD	17	53PK40	37
50-ISO4-16-RO	8	50-ISO9-18-RO-BSD	10	50-ISO13-R20-RO	16	53PK50	37
50-ISO4-16-RO-BSD	9	50-ISO9-20-BL	10	50-ISO13-R20-RO-BSD	17	53PK63	37
50-ISO4-18-BL	8	50-ISO9-20-BL-BSD	10	50-ISO13-R26-BL	16	53PKS40	170
50-ISO4-18-BL-BSD	9	50-ISO9-20-RO	9	50-ISO13-R26-BL-BSD	17	53PKS50	170
50-ISO4-18-RO	8	50-ISO9-20-RO-BSD	10	50-ISO13-R26-RO	16	53PKS63	170
50-ISO4-18-RO-BSD	9	50-ISO9-26-BL	10	50-ISO13-R26-RO-BSD	17	100-016MB	12
50-ISO4-20-BL	8	50-ISO9-26-BL-BSD	10	50-ISO20-R16-BL	17	100-016MBLACK	12
50-ISO4-20-BL-BSD	9	50-ISO9-26-RO	10	50-ISO20-R16-BL-BSD	17	100-016MR	12
50-ISO4-20-RO	8	50-ISO9-26-RO-BSD	10	50-ISO20-R16-RO	17	100-018MB	12
50-ISO4-20-RO-BSD	9	50-ISO9-32-BL	10	50-ISO20-R16-RO-BSD	17	100-018MR	12
50-ISO4-26-BL	8	50-ISO9-32-BL-BSD	10	50-ISO20-R20-BL	17	100-020MB	12
50-ISO4-26-BL-BSD	9	50-ISO9-32-RO	10	50-ISO20-R20-BL-BSD	17	100-020MR	12
50-ISO4-26-RO	8	50-ISO9-32-RO-BSD	10	50-ISO20-R20-RO	17	100-121688	7
50-ISO4-26-RO-BSD	9	50-ISO9-R16-BL	16	50-ISO20-R20-RO-BSD	17	100-140210	7
50-ISO4-32-BL	8	50-ISO9-R16-BL-BSD	16	50-MB20	22	100-160212	7
50-ISO4-32-BL-BSD	9	50-ISO9-R16-RO	16	50-MB26	22	100-180214	7
50-ISO4-32-RO	8	50-ISO9-R16-RO-BSD	16	50-MBLACK20	22	100-200216	7
50-ISO4-32-RO-BSD	9	50-ISO9-R20-BL	16	50-MBLACK26	22	100-F16R-WZ	19
50-ISO4-COMBI16R	18	50-ISO9-R20-BL-BSD	16	50-MG16	22	100-F20R-WZ	19
50-ISO4-R16-BL	15	50-ISO9-R20-RO	16	50-MG20	22	100-ISO4-14-BL	8
50-ISO4-R16-BL-BSD	15	50-ISO9-R20-RO-BSD	16	50-MG26	22	100-ISO4-14-BL-BSD	9
50-ISO4-R16-RO	15	50-ISO9-R26-BL	16	50-MR20	22	100-ISO4-14-RO	8
50-ISO4-R16-RO-BSD	15	50-ISO9-R26-BL-BSD	16	50-MR26	22	100-ISO4-14-RO-BSD	9
50-ISO4-R18-BL	15	50-ISO9-R26-RO	16	50-MXC1620	64	100-ISO4-16-BL	8
50-ISO4-R18-BL-BSD	15	50-ISO9-R26-RO-BSD	16	50P43-320604	170	100-ISO4-16-BL-BSD	9
50-ISO4-R18-RO	15	50-ISO13-16-BL	10	50P-3206	170	100-ISO4-16-RO	8
50-ISO4-R18-RO-BSD	15	50-ISO13-16-BL-BSD	11	50P-320604	170	100-ISO4-16-RO-BSD	9
50-ISO4-R20-BL	15	50-ISO13-16-RO	10	50P-320605	170	100-ISO4-20-BL	8

INDEX

Article number	Page	Article number	Page	Article number	Page	Article number	Page
100-ISO4-20-BL-BSD	9	AD-EKEK	98	BE14HC	149	BE32H	149
100-ISO4-20-RO	8	AK-EK05VD	162	BE14M	154	BE32MINI	153
100-ISO4-20-RO-BSD	9	AN1420	98	BE14MINI3	152	BE32MINI3	152
100-ISO4-R16-BL	15	AT1420	98	BE15C	153	BE32MINI-RMS	154
100-ISO4-R16-BL-BSD	15	BA-1288	140	BE15HC	149	BE40	147
100-ISO4-R16-RO	15	BA-1410	140	BE15HM	149	BE50	147
100-ISO4-R16-RO-BSD	15	BA-1612	140	BE15MMINI	153	BE63	147
100-MB	22	BA-1814	140	BE15M-MINI3	152	BE-BOX	149
100-MBLACK	22	BA-2016	140	BE15V-MINI3	152	BE-MINI	153
100-MG16	22	BA-F41	112	BE16	147	BE-MINI3	152
100-MR	22	BAP-FFV16Z05	111	BE16H	149	BE-UNI	148
100-R16MB	18	BAP-FFV20Z05	111	BE16HC	149	BE-UNISSET1	147
100-R16MBLACK	18	BAP-FFV26Z05	111	BE16M	154	BE-UNISSET2	147
100-R16MR	18	BAP-FFV26Z06	111	BE16MINI	153	BE-UNISSETMINI3	148
100-R20MB	18	BAP-FFV32Z06	111	BE16MINI3	152	BI-1410	140
100-R20MR	18	BAP-FFV1604	111	BE16MINI-RMS	154	BI-1612	140
100-R160212	14	BAP-FFV1605EK	111	BE18	147	BI-1612L	140
100-R180214	14	BAP-FFV1616	111	BE18C	153	BI-1814	140
100-R200216	14	BAP-FFV1805	111	BE18H	149	BI-2016	140
120-PRT1620	21	BAP-FFV2005	111	BE18HC	149	BI-2016L	140
200-121688	7	BAP-FFV2005EK	111	BE18HM	149	BI-2620	140
200-140210	7	BAP-FFV2020	111	BE18M	154	BM-16	141
200-160212	7	BAP-FFV2605	111	BE18M-MINI3	152	BM-16F	141
200-180214	7	BAP-FFV2605EK	111	BE18V-MINI3	152	BM-18	141
200-F16R-WZ	19	BAP-FFV2606	111	BE20	147	BM-20	141
200-PXC1620	20	BAP-FFV2626	111	BE20H	149	BM-20F	141
200-PXC1720	20	BAP-FFV3207	111	BE20M	154	BM-26	141
200-PXC2020	20	BAP-FFV3232	111	BE20MINI	153	BP04	27
200-R160212	14	BAP-H1616	112	BE20MINI3	152	CU-6ZONEB-H	132
200-R180214	14	BAP-H2020	112	BE20MINI-RMS	154	CU-6ZONEB-HC	132
240-PRT1820	21	BAP-H2626	112	BE22C	153	CU-6ZONE-CON	132
240-PXC1820	20	BAP-H3232	112	BE22HC	149	CU-6ZONERF-HC	135
270-PRT1620	21	BAP-SV1610S	112	BE22HM	149	CU-10ZONERF-HC	135
500-160212D	7	BCLIP-16	160	BE22MMINI	153	CU-ACT-B230V	133
500-F16R-WZ	19	BCLIP-26	160	BE22M-MINI3	152	CU-ACT-B230V	136
500-R160212D	14	BCLIP-32	160	BE22V-MINI3	152	CU-ANTRF	136
600-PRT1420	21	BCLIP-40	160	BE26	147	CU-ATHERMB-H	132
600-PRT1720	21	BCLIP-50	160	BE26H	149	CU-ATHERMB-HC	132
600-PRT1820	21	BCLIP-1820	160	BE26MINI	153	CU-ATHERMRF-HC	135
600-PRT2020	21	BDB33M	162	BE26MINI3	152	CU-DTHERMB-HC	133
600-PXC1620	20	BDR33M	162	BE26MINI-RMS	154	CU-DTHERMRF-HC	135
600-PXC1720	20	BE12HC	149	BE28C	153	CU-RADTHERMRF	136
600-PXC2020	20	BE12HM	149	BE28HC	149	CU-REPRF	136
640-PRT1620	21	BE12M-MINI3	152	BE28M-MINI3	152	CU-WIFIRF	136
AB1420	97	BE14	147	BE28V-MINI3	152	CU-WIFIRFCABLE	136
ABEK04	97	BE14H	149	BE32	147	CU-ZONERF-HC	135

Article number	Page	Article number	Page	Article number	Page	Article number	Page
DRILLY14	155	KS16M	143	PK-TOOL04	156	SPR-CBLOCK-TF	172
DRILLY16	155	KS18M	143	PK-TOOL05	156	SPR-FIXGLUE	173
DRILLY20	155	KS20M	143	PK-TOOL06	156	SPR-FIXSCREW	173
DRILLY26	155	KS26M	143	PK-TOOLBOX	156	SPR-ISO	173
DRILLY32	155	KS32M	143	PK-TOOLBOX-040506	156	SPR-ISO-MAGNET26	173
EK12-2	96	KS40M	143	PLF-P-PK	161	SPR-ISO-WS	172
EK14-2	96	KS50	143	PLP-P-PK	161	SPR-MAGNET26	173
EK15	97	KS63	143	PLUG04-B80	155	SPR-MAGNET31	173
EK15	113	KS-K	144	PLUG04-R80	155	SPR-N0604IDL00H15	174
EK16-2	96	KS-MSET1	143	PLUG05-B80	155	SPR-N0604IDL05H20	174
EK17-2	96	KS-MSET4	143	PLUG05-R80	155	SPR-N0604IDL10H25	174
EK18-2	96	KS-P162026	144	P-PIPESTOP16	87	SPR-N0604IDL15H30	174
EK20-2	96	M-BA03	145	P-PIPESTOP20	87	SPR-N0604IDL20H35	174
ENDCAP-EK05	104	M-BAT03	145	P-PIPESTOP26	87	SPR-N0604IDL25H40	174
H-0212	109	M-BATMINI2	153	P-PIPESTOP32	87	SPR-N0604IDL30H45	174
H-0212-C	109	M-BATMINI3-2.0AH	151	PRESSCHECK1432	155	SPR-N0604IDLXXH00	174
H-0212-S	109	M-BATMINI3-5.0AH	151	PS-16	140	SPR-N0604IDLXXH05	174
HFMAN125	162	M-BH162026	154	PS-20	140	SPR-N0604IDLXXH10	174
HNA	57	M-BHY	146	RAD04-100V	113	SPR-OP06	172
HNA-COMP	59	M-BHY162026	146	RADNI-0504	113	SPR-PLUGTOOL	175
HNA-EK05	59	M-BM1620	154	RADTH-VL	113	SPR-PULLTOOL	175
HNA-EK05-E	59	M-BMINI3	150	RS32	142	TESTPLUG16	161
HNAFL-DN50	59	M-BMINI3-F	150	RSEM1420-PERS	142	TESTPLUG16-RO	161
HNA-INLB	59	M-BMINI3-S	150	RSEM2640-PERS	142	TESTPLUG20	161
HNA-INLB-E	59	M-BOXBA03	145	SAFECUT	140	TESTPLUG20-RO	161
HNA-STOP	58	M-BOXBHY	147	SK-B05	72	TESTPLUG26	161
HNA-STOP-E	58	M-BOXMINI3	151	SK-B05	105	TESTPLUG26-RO	161
HNA-U	57	M-BOXMINI3-F	151	SK-B05	108	TOOLBOX405063	148
HNB	57	M-HP32	154	SK-PIPESTOP16	71	TOOLBOX16202632	148
HNB-STOP	58	M-LAD03	146	SK-PIPESTOP20	71	UFH-0405CDP01	122
HNB-U	57	M-LADMINI3	151	SK-PIPESTOP26	71	UFH-0405CDP02	122
HN-PEN	57	M-TRANS03	146	SK-STOPCLIP16	71	UFH-0405CDP03	122
HNTOOLSET	155	M-TRANSMINI3	151	SK-STOPCLIP16	104	UFH-0405CDP04	122
IM63	142	N04	80	SK-STOPCLIP20	71	UFH-0405CDP05	122
IM1426PRESS	141	N05	80	SK-STOPCLIP20	104	UFH-0405CDP06	122
IM1426PRESS-N	141	N06	80	SK-STOPCLIP26	71	UFH-0405SLT01	123
IMEM63	142	N0404-X	37	SK-STOPCLIP26	104	UFH-0405SLT02	123
IMEM1426-PRESS	141	N0404-X	47	SPLIT-14	97	UFH-0405SLT03	123
ISO-BLOCK-S	13	N0505-X	37	SPLIT-16	97	UFH-0405SLT04	123
ISO-BOX	82	N0505-X	47	SPLIT-20	97	UFH-0405SLT05	123
JCLIP-1632	160	N0606-X	37	SPLIT-S16	97	UFH-0405SLT06	123
JCLIP-1632D	160	N0606-X	47	SPLIT-S20	97	UFH-0405SSTE02-PN6	123
JCLIP-1632DL	160	PH-1632	142	SPLIT-S26	97	UFH-0405SSTE03-PN6	123
JCLIP-1632L	160	PIPEPLUG16	161	SPR-CBLOCK	172	UFH-0405SSTE04-PN6	123
KS12M	143	PIPEPLUG20	161	SPR-CBLOCK80	172	UFH-0405SSTE06-PN6	123
KS14M	143	PIPEPLUG26	161	SPR-CBLOCK80-WS	172	UFH-0505CDP07	122

INDEX

Article number	Page	Article number	Page	Article number	Page	Article number	Page
UFH-0505CDP08	122	UFH-0605MDK03-03L	124	UFH-ANC05	133	UFH-DRY-GP100/2	118
UFH-0505CDP09	122	UFH-0605MDK03-03LPRM	124	UFH-ANC056	133	UFH-ESK060303-M	128
UFH-0505CDP10	122	UFH-0605MDK04-03L	124	UFH-AO03-MZ	128	UFH-ESK060303-VN	128
UFH-0505CDP11	122	UFH-0605MDK04-03LPRM	124	UFH-B0605-VN	129	UFH-FOIL50	119
UFH-0505CDP12	122	UFH-0605MDK05-03L	124	UFH-B0606-M	128	UFH-FOIL90	119
UFH-0505CDP13	122	UFH-0605MDK05-03LPRM	124	UFH-B0606-VN	129	UFH-FOIL-ALU	119
UFH-0505CDP14	122	UFH-0605MDK06-03L	124	UFH-BEND20	121	UFH-FOIL-CLIP25	119
UFH-0505CDP15	122	UFH-0605MDK06-03LPRM	124	UFH-BEND1218	121	UFH-FOIL-N	119
UFH-0505CDP16	122	UFH-0605MDK07-03L	124	UFH-BM0606-VN	129	UFH-GKT	127
UFH-0505SLT07	123	UFH-0605MDK07-03LPRM	124	UFH-BMH0606T-VN	129	UFH-ISOBOARD-GV	120
UFH-0505SLT08	123	UFH-0605MDK08-03L	124	UFH-BMH0606-VN	129	UFH-ISOBOARD-GVNL	120
UFH-0505SLT09	123	UFH-0605MDK08-03LPRM	124	UFH-BS05-M	128	UFH-ISOBOARD-S	120
UFH-0505SLT10	123	UFH-0605MDK09-03L	124	UFH-BTM0606-M	127	UFH-ISODRY-25	118
UFH-0505SLT11	123	UFH-0605MDK09-03LPRM	124	UFH-C191800	130	UFH-ISOPRO11	115
UFH-0505SLT12	123	UFH-0605MDK10-03L	124	UFH-C191974	130	UFH-ISOPRO30	115
UFH-0505SLT14	123	UFH-0605MDK10-03LPRM	124	UFH-C191976	130	UFH-M-D	126
UFH-0505SLT15	123	UFH-0605MDK11-03L	124	UFH-C192071	130	UFH-MDK-AO	126
UFH-0505SLT16	123	UFH-0605MDK11-03LPRM	124	UFH-C260003001	129	UFH-MDK-CON	126
UFH-0505SSTE07-PN6	123	UFH-0605MDK12-03L	124	UFH-CAB-I400	138	UFH-P18-GP10	118
UFH-0505SSTE08-PN6	123	UFH-0605MDK12-03LPRM	124	UFH-CAB-I455	138	UFH-P18-GP18	117
UFH-0505SSTE09-PN6	123	UFH-0605MDSS02	125	UFH-CAB-I565	138	UFH-P18-GP18V	118
UFH-0505SSTE10-PN6	123	UFH-0605MDSS03	125	UFH-CAB-I715	138	UFH-P18-WN	118
UFH-0505SSTE11-PN6	123	UFH-0605MDSS04	125	UFH-CAB-I965	138	UFH-PGKTA	127
UFH-0505SSTE12-PN6	123	UFH-0605MDSS05	125	UFH-CAB-O385	138	UFH-PGKTA-TH	127
UFH-0605CD01	122	UFH-0605MDSS06	125	UFH-CAB-O385Z	138	UFH-PLUG80	120
UFH-0605CD02	122	UFH-0605MDSS07	125	UFH-CAB-O400	138	UFH-PRO	115
UFH-0605CD03	122	UFH-0605MDSS08	125	UFH-CAB-O615	138	UFH-RAS10	115
UFH-0605CD04	122	UFH-0605MDSS09	125	UFH-CAB-O615Z	138	UFH-RAS15	115
UFH-0605CD05	122	UFH-0605MDSS10	125	UFH-CAB-O800	138	UFH-RAS20	115
UFH-0605CD06	122	UFH-0605MDSS11	125	UFH-CAB-O1015	138	UFH-RAS-BIND15A	116
UFH-0605CD07	122	UFH-0605MDSS12	125	UFH-CAB-O1015Z	138	UFH-RAS-BIND15B	116
UFH-0605CD08	122	UFH-0605MDSS13	125	UFH-CASTMAT16	115	UFH-RAS-CLIP16	116
UFH-0605CD09	122	UFH-0605MDSS14	125	UFH-CMDK03	126	UFH-RAS-CLIP18	116
UFH-0605CD10	122	UFH-0605MDSS15	125	UFH-CMDK10	126	UFH-RAS-CLIP20	116
UFH-0605CD11	122	UFH-060502-MD	126	UFH-CMDSS03	127	UFH-RAS-CUT	158
UFH-0605CD12	122	UFH-060503-MD	126	UFH-CP	122	UFH-RAS-RB3	115
UFH-0605CD13	122	UFH-060504-MD	126	UFH-DH40	121	UFH-RAS-VLE	158
UFH-0605CD14	122	UFH-060505-MD	126	UFH-DP200	120	UFH-SCOTCH-66	117
UFH-0605CD15	122	UFH-060506-MD	126	UFH-DRY-1617-150F	117	UFH-TACK	157
UFH-0605CD16	122	UFH-060507-MD	126	UFH-DRY-1617-200F	117	UFH-TACK-38K	116
UFH-0605CD17	122	UFH-060508-MD	126	UFH-DRY-1625-100F	117	UFH-TACK-40	116
UFH-0605CD18	122	UFH-060509-MD	126	UFH-DRY-1625-150F	117	UFH-TACK-60	116
UFH-0605CD19	122	UFH-060510-MD	126	UFH-DRY-1625-200F	117	UFH-TACK-KLS20	116
UFH-0605CD20	122	UFH-060511-MD	126	UFH-DRY-1630-150F	117	UFH-TACK-KLS25	116
UFH-0605MDK02-03L	124	UFH-060512-MD	126	UFH-DRY-FTAPE	117	UFH-TACK-KLS30	116
UFH-0605MDK02-03LPRM	124	UFH-ADN10	121	UFH-DRY-GLUEF	117	UFH-TACK-KLS40	116

Article number	Page	Article number	Page	Article number	Page
UFH-TM050-M	128	VBS060504-BL	107	VVSK-26	102
UFH-UP-12	119	VBS060504-RO	107	VVSK-26-90	103
UFH-UP-14M1	118	VDEK-T05	103	VVSK-T20M20	102
UFH-UP-16	119	VDSK-20	104	VVSK-T26M26	102
UFH-UP-16M1	118	VDSK-26	104	VVSK-T202020	103
UFH-UP-CUP50	119	VEK-060502	108	VVSK-T262626	103
UFH-VLA	157	VEK-060503	108	WBP-1604-BL	87
UFH-VLA-STR	157	VEK-060503-Z	108	WBP-1604-RO	87
V-050404-Z	108	VEK-060504	108	WBP-2004-BL	87
V-060402	108	VEK-060504-Z	108	WBP-2004-RO	87
V-060404	108	VEK-060505	108	WBPL-X	87
V-060405	108	VEK-060505-Z	108	WBPL-X	99
V-060406	108	VEK-060506-Z	108	WBS-1604-BL	98
VB050502-BLAUW	106	VEK-060507	108	WBS-1604-RO	98
VB050502-ROOD	106	VEK-060507-Z	108		
VB050503-BLAUW	106	VEK-060508	108		
VB050503-ROOD	106	VEK-060508-Z	108		
VB050504-BLAUW	106	VEK-060509-Z	108		
VB050504-ROOD	106	VEK-060510-Z	108		
VB060502-BLAUW	106	VISION-KEY16	71		
VB060502-ROOD	106	VISION-KEY20	71		
VB060503-BLAUW	106	VISION-KEY26	71		
VB060503-ROOD	106	VISION SET 16	71		
VB060504-BLAUW	106	VISION SET 20	71		
VB060504-ROOD	106	VISION SET 26	71		
VB-EK05	106	VS-05	109		
VB-EK05	112	VS-06	109		
VB-HANDLE-BLUE	106	VS-07	109		
VB-HANDLE-RED	106	VS-0504	109		
VBS-05	106	VS-0604	109		
VBS-05F	107	VS-0605	109		
VBS-06	106	VS-ENDCAP	103		
VBS-06F	107	VS-ENDCAP-M	104		
VBS050502-BL	107	VSK-1616	72		
VBS050502-GR	107	VSK-161616	72		
VBS050502-RO	107	VSKEK-0502	101		
VBS050503-BL	107	VSKEK-0503	101		
VBS050503-GR	107	VSKEK-ISO12	101		
VBS050503-RO	107	VVPK-20	105		
VBS050504-BL	107	VVPK-26	105		
VBS050504-GR	107	VVPK90-20-D	105		
VBS050504-RO	107	VVPK90-20-U	105		
VBS060502-BL	107	VVPK90-26-D	105		
VBS060502-RO	107	VVPK90-26-U	105		
VBS060503-BL	107	VVSK-20	102		
VBS060503-RO	107	VVSK-20-90	103		

Blank page with horizontal dotted lines for writing.

Handwriting practice lines consisting of 20 horizontal dotted lines.



We care to connect

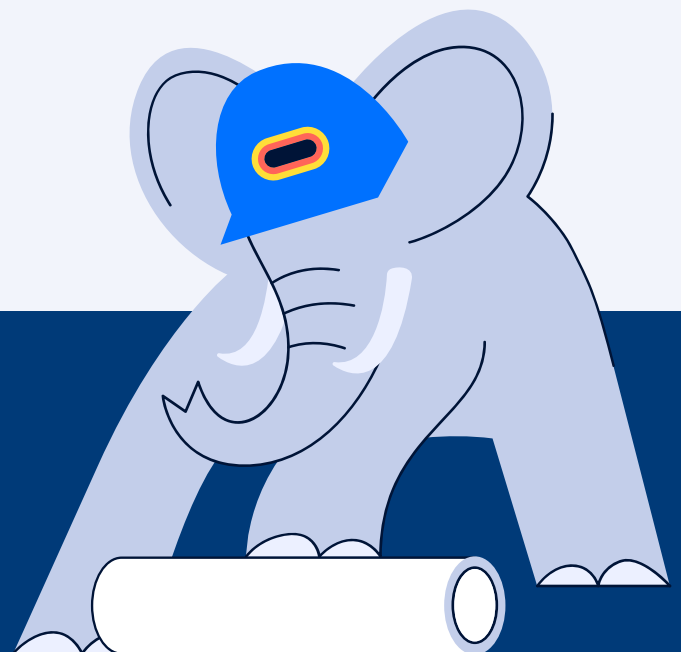

MyHenco

The best of Henco **always at hand.**



Register now
for free.