

1992 - 2022 WE CELEBRATE 30 YEARS

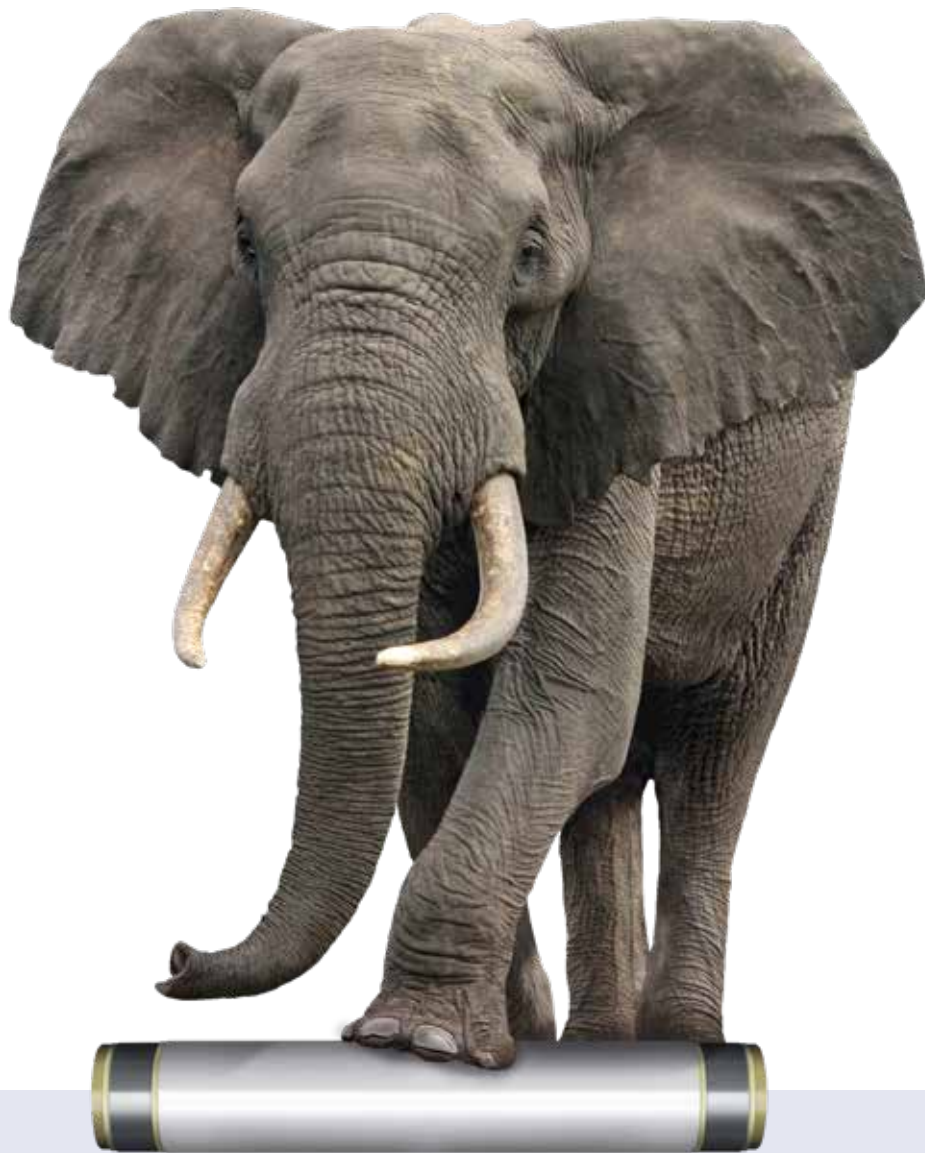

PRODUCT OVERVIEW 2022/02

HENCO **PRODUCT OVERVIEW** 2022



EN / ESP / POR



SANITARY



RADIATOR



FLOOR HEATING



GAS



SPRINKLER



COMPRESSED AIR

PRODUCT OVERVIEW 2022/02



WE CARE TO CONNECT

1. Pipes

A. STANDARD (PE-Xc/AL/PE-Xc)	6
B. RIXc (PE-Xc/AL/PE-Xc)	7
C. FLOOR-RIXc (PE-Xc/AL/PE-Xc)	13
D. PE-Xc	16
E. PE-RT	17
F. PROTECTION HOSE	18
G. GAS STANDARD (PE-Xc/AL/PE-Xc)	19
H. SPRINKLER	20
	21

2. Henco Press	22
A. PK	23
B. PKW	37
C. PKG	45
D. PKS (SPRINKLER)	50
E. SUPER SIZE	56
F. HENCO ECOLINE	62
3. Henco Vision	63
A. SK	64
B. MANIFOLDS	70
4. Brass press fittings	71
A. P	72
B. PG	84
5. Brass compression fittings	88
6. Manifolds	95
A. FULL FLOW MANIFOLD	96
B. BRASS	101
7. Valves	105
8. Underfloor heating	110
A. SYSTEMS	111
B. MANIFOLDS	119
C. CONTROL UNITS	127
9. Cabinets	135
10. Tools	137
11. Accessories	158
12. Prefab	161
Certificates	164
Index	166



Sustainability, also our concern

Sustainability is an important concept at Henco. Apart from offering sustainable solutions, such as underfloor heating, we also want to operate sustainably as a company. This implies taking the 3 P's into account: planet, people and profit.

To us, corporate sustainability means paying attention to these three pillars by taking a variety of actions internally. For instance, it is important to deal sustainably with internal employees, to conduct a correct environmental policy and to use our profits wisely.

Recently, we mapped our total CO²-footprint, including scope 1,2 & 3 emissions and developed an action plan to reduce significantly during coming year.



ISO14001 certified

All the effort we put into environmental matters resulted in Henco getting through the certification audits for ISO14001. After 3 days of audits on various business processes, we achieved a very positive audit result without any recorded remarks. The auditor praised, among other things, the enthusiasm of our employees and the broad demonstration of sustainability throughout our processes.



Aalberts Sustainability Award 2021

Aalberts also saw that we at Henco value sustainability and that we show this through all our actions. In 2022 we were very pleased to accept the Aalberts sustainability awards 2021.

The VOKA sustainability charter: SDG pioneers

The VOKA sustainability charter was achieved by Henco for the 3rd year in a row. With this, we have officially been appointed as SDG pioneers. Sustainability is held in high esteem at Henco, this certificate proves it and we are proud of it.



Environmental and health statement Cochebat

The French HVAC association Cochebat has tested and approved our Henco multilayer pipes and we were rewarded with inclusion in their Environmental and Health Statement.

Interseroh Certificate Resources Saved

In 2020 and 2021 Henco received the Interseroh Certificate for Resources Saved in Germany. By recycling materials in 2021, a calculated 42,269 kilograms of resources and, in addition to this, 5,521 kilograms of greenhouse gases were saved.



	Page
A. STANDARD (PE-Xc/AL/PE-Xc)	7
B. RIXc (PE-Xc/AL/PE-Xc)	13
C. FLOOR-RIXc (PE-Xc/AL/PE-Xc)	16
D. PE-Xc	17
E. PE-RT	18
F. PROTECTION HOSE	19
G. GAS STANDARD (PE-Xc/AL/PE-Xc)	20
H. SPRINKLER	21

A. STANDARD (PE-Xc/AL/PE-Xc)



Type: COIL



Henco multilayer pipe (Coil)

Tubo Henco multicapa (Rollo)

Tubo multicamada Henco Premium (Rolo)

Article number	m / Pallet	Type	Pallet dimension
100-121688 *	100 m / 2200 m	12x1,6	75x75 cm
200-121688 *	200 m / 3000 m	12x1,6	75x75 cm
100-140210	100 m / 2200 m	14x2	75x75 cm
200-140210	200 m / 3000 m	14x2	80x80 cm
50-160212	50 m / 1500 m	16x2	120x80 cm
100-160212	100 m / 2200 m	16x2	75x75 cm
200-160212	200 m / 2600 m	16x2	75x75 cm
500-160212D	500 m / 2500 m	16x2	80x80 cm
100-180214	100 m / 1700 m	18x2	75x75 cm
200-180214	200 m / 2000 m	18x2	75x75 cm
25-200216	25 m / 800 m	20x2	120x80 cm
50-200216	50 m / 1000 m	20x2	120x80 cm
100-200216	100 m / 1500 m	20x2	75x75 cm
50-260320	50 m / 800 m	26x3	75x75 cm
50-320326	50 m / 650 m	32x3	90x90 cm

* 6 bar - 60°C

Type: COIL CSC



Henco multilayer pipe (Coil Small Core)

Tubo Henco multicapa (Rollo pequeño)

Tubo Henco multicamada Premium (rolo pequeño)

Article number	m / Pallet	Type	Pallet dimension
10-160212-KB	10 m / 800 m	16x2	120x80 cm
15-160212-KB	15 m / 900 m	16x2	120x80 cm
25-160212-KB	25 m / 1125 m	16x2	120x80 cm
25-200216-KB	25 m / 900 m	20x2	120x80 cm

ID Coil: 28cm



A. STANDARD (PE-Xc/AL/PE-Xc)

1

Type: STRAIGHT LENGTH

2

3

4

5

6

7

8

9

10

11

12



Henco multilayer pipe (Straight length)

Tubo Henco multicapa (Barra)

Tubo multicamada Henco Premium (vara)

Article number	Cylinder / Pallet	Type	Pallet dimension
03-160212	75 m / 3600 m	16x2	310x70,5cm
04-160212	100 m / 4800 m	16x2	410x70,5 cm
05-160212	125 m / 6000 m	16x2	510x70,5 cm
03-180214	60 m / 2880 m	18x2	310x70,5 cm
05-180214	100 m / 4800 m	18x2	510x70,5 cm
03-200216	54 m / 2592 m	20x2	310x70,5 cm
04-200216	72 m / 3456 m	20x2	410x70,5 cm
05-200216	90 m / 4320 m	20x2	510x70,5 cm
03-260320	30 m / 1440 m	26x3	310x70,5 cm
04-260320	40 m / 1920 m	26x3	410x70,5 cm
05-260320	50 m / 2400 m	26x3	510x70,5 cm
03-320326	21 m / 1008 m	32x3	310x70,5 cm
04-320326	28 m / 1344 m	32x3	410x70,5 cm
05-320326	35 m / 1680 m	32x3	510x70,5cm
03-403533	27 m / 648 m	40x3,5	310x70,5 cm
04-403533	36 m / 864 m	40x3,5	410x70,5 cm
05-403533	45 m / 1080 m	40x3,5	510x70,5 cm
03-504042	21 m / 504 m	50x4	310x70,5 cm
04-504042	28 m / 672 m	50x4	410x70,5 cm
05-504042	35 m / 840 m	50x4	510x70,5 cm
03-634554	12 m / 288 m	63x4,5	310x70,5 cm
04-634554	16 m / 384 m	63x4,5	410x70,5 cm
05-634554	20 m / 480 m	63x4,5	510x70,5 cm
05-756063	10 m / 240 m	75x6	510x70,5 cm
05-907076	5 m / 240 m	90x7	510x70,5 cm

Type: ISO4 (6 mm)



Pre-insulated (Coil)

Tubo Henco multicapa preaislado (Rollo)

Tubo pré-isolado

Article number	m / Pallet	Type	Pallet dimension
100-ISO4-14-RO	100 m / 1000 m	14x2 red	75x75 cm
100-ISO4-14-BL	100 m / 1000 m	14x2 blue	75x75 cm
50-ISO4-16-RO	50 m / 700 m	16x2 red	75x75 cm
50-ISO4-16-BL	50 m / 700 m	16x2 blue	75x75 cm
100-ISO4-16-RO	100 m / 1300 m	16x2 red	75x75 cm
100-ISO4-16-BL	100 m / 1300 m	16x2 blue	75x75 cm
50-ISO4-18-RO	50 m / 650 m	18x2 red	75x75 cm
50-ISO4-18-BL	50 m / 650 m	18x2 blue	75x75 cm
50-ISO4-20-RO	50 m / 700 m	20x2 red	75x75 cm
50-ISO4-20-BL	50 m / 700 m	20x2 blue	75x75 cm
100-ISO4-20-RO	100 m / 700 m	20x2 red	75x75 cm
100-ISO4-20-BL	100 m / 700 m	20x2 blue	75x75 cm
25-ISO4-26-RO	25 m / 300 m	26x3 red	75x75 cm
25-ISO4-26-BL	25 m / 300 m	26x3 blue	75x75 cm
50-ISO4-26-RO	50 m / 500 m	26x3 red	75x75 cm
50-ISO4-26-BL	50 m / 500 m	26x3 blue	75x75 cm
25-ISO4-32-RO	25 m / 300 m	32x3 red	75x75 cm
25-ISO4-32-BL	25 m / 300 m	32x3 blue	75x75 cm
50-ISO4-32-RO	50 m / 300 m	32x3 red	75x75 cm
50-ISO4-32-BL	50 m / 300 m	32x3 blue	75x75 cm

A. STANDARD (PE-Xc/AL/PE-Xc)



Type: ISO9 (10 mm)



Pre-insulated (Coil)

Tubo Henco multicapa preaislado (Rollo)

Tubo pré-isolado

Article number	m / Pallet	Type	Pallet dimension
50-ISO9-14-RO	50 m / 550 m	14x2 red	75x75 cm
50-ISO9-14-BL	50 m / 550 m	14x2 blue	75x75 cm
50-ISO9-16-RO	50 m / 550 m	16x2 red	75x75 cm
50-ISO9-16-BL	50 m / 550 m	16x2 blue	75x75 cm
50-ISO9-18-RO	50 m / 500 m	18x2 red	75x75 cm
50-ISO9-18-BL	50 m / 500 m	18x2 blue	75x75 cm
50-ISO9-20-RO	50 m / 500 m	20x2 red	75x75 cm
50-ISO9-20-BL	50 m / 500 m	20x2 blue	75x75 cm
25-ISO9-26-RO	25 m / 275 m	26x3 red	75x75 cm
25-ISO9-26-BL	25 m / 275 m	26x3 blue	75x75 cm
50-ISO9-26-RO	50 m / 450 m	26x3 red	75x75 cm
50-ISO9-26-BL	50 m / 450 m	26x3 blue	75x75 cm
25-ISO9-32-RO	25 m / 250 m	32x3 red	75x75 cm
25-ISO9-32-BL	25 m / 250 m	32x3 blue	75x75 cm
50-ISO9-32-RO	50 m / 350 m	32x3 red	75x75 cm
50-ISO9-32-BL	50 m / 350 m	32x3 blue	75x75 cm

Type: ISO13 (13 mm)



Pre-insulated (Coil)

Tubo Henco multicapa preaislado (Rollo)

Tubo pré-isolado

Article number	m / Pallet	Type	Pallet dimension
50-ISO13-16-RO	50 m / 400 m	16x2 blue	75x75 cm
50-ISO13-16-BL	50 m / 400 m	16x2 blue	75x75 cm
50-ISO13-18-BL	50 m / 400 m	18x2 blue	75x75 cm
50-ISO13-20-RO	50 m / 400 m	20x2 blue	75x75 cm
50-ISO13-20-BL	50 m / 400 m	20x2 blue	75x75 cm
50-ISO13-26-RO	50 m / 400 m	26x3 blue	75x75 cm
50-ISO13-26-BL	50 m / 400 m	26x3 blue	75x75 cm
25-ISO13-32-RO	25 m / 250 m	32x3 blue	75x75 cm
25-ISO13-32-BL	25 m / 200 m	32x3 blue	75x75 cm

Type: COMBI ISO4 (6 mm)



Henco Combi iso 6 mm (Coil)

Tubo Henco multicapa Combi ISO 6mm (Rollo)

Tubo multicamada Henco Combi ISO

Article number	m / Pallet	Type	Pallet dimension
50-ISO4-COMBI16	50 m / 400 m	16x2	80x80 cm



REPAIR TAPE p 160



A. STANDARD (PE-Xc/AL/PE-Xc)

1 Type: STANDARD PIPE IN PIPE



With colour coded conduit (Coil)

Tubo Henco multicapa con corrugado por color (Rollo)

Tubo multicamada Henco com manga de proteção corrugada (Rolo)

Article number	m / Pallet	Type	Pallet dimension
25-014MR	25 m / 500 m	14x2 red	120x80 cm
25-014MB	25 m / 500 m	14x2 blue	120x80 cm
50-014MR	50 m / 800 m	14x2 red	120x80 cm
50-014MB	50 m / 800 m	14x2 blue	120x80 cm
100-014MR	100 m / 1000 m	14x2 red	120x80 cm
100-014MBLACK	100 m / 1000 m	14x2 black	120x80 cm
25-016MR	25 m / 500 m	16x2 red	120x80 cm
25-016MB	25 m / 500 m	16x2 blue	120x80 cm
50-016MR	50 m / 800 m	16x2 red	120x80 cm
50-016MB	50 m / 800 m	16x2 blue	120x80 cm
50-016MBLACK	50 m / 800 m	16x2 black	120x80 cm
100-016MR	100 m / 1000 m	16x2 red	120x80 cm
100-016MB	100 m / 1000 m	16x2 blue	120x80 cm
100-016MBLACK	100 m / 1000 m	16x2 black	120x80 cm
50-018MR	50 m / 800 m	18x2 red	120x80 cm
50-018MB	50 m / 800 m	18x2 blue	120x80 cm
100-018MR	100 m / 1000 m	18x2 red	120x80 cm
100-018MB	100 m / 1000 m	18x2 blue	120x80 cm
25-020MR	25 m / 500 m	20x2 red	120x80 cm
25-020MB	25 m / 500 m	20x2 blue	120x80 cm
25-020MBLACK	25 m / 500 m	20x2 black	120x80 cm
50-020MR	50 m / 800 m	20x2 red	120x80 cm
50-020MB	50 m / 800 m	20x2 blue	120x80 cm
50-020MBLACK	50 m / 800 m	20x2 black	120x80 cm
100-020MB	100 m / 1000 m	20x2 blue	120x80 cm
100-020MR	100 m / 1000 m	20x2 red	120x80 cm
25-026MR	25 m / 500 m	26x3 red	120x80 cm
25-026MB	25 m / 500 m	26x3 blue	120x80 cm
50-026MR	50 m / 500 m	26x3 red	120x80 cm
50-026MB	50 m / 500 m	26x3 blue	120x80 cm
50-026MBLACK	50 m / 500 m	26x3 black	120x80 cm
25-032MR	25 m / 300 m	32x3 red	120x80 cm
25-032MB	25 m / 300 m	32x3 blue	120x80 cm

Type: COMBI STANDARD



Henco Combi (Coil)

Tubo Henco multicapa con corrugado Combi (Rollo)

Tubo multicamada Henco Combi (Rolo)

Article number	m / Pallet	Type	Pallet dimension
50-COMBI16	50 m / 800 m	16x2	120x80 cm

A. STANDARD (PE-Xc/AL/PE-Xc)



Type: FLEX STANDARD



Henco Flex (Coil)
Henco Flex (Rollo)
Henco Flex (Rolo)

Article number	Packing	Type
100-FLEX26	100 m	2 - 26x3 (OD90)
100-FLEX32	100 m	2 - 32x3 (OD125)

TILL EXHAUSTION OF STOCK

Type: STANDARD PIPE IN PIPE CSC



With colour coded conduit (Coil Small Core)

Tubo Henco multicapa con corrugado por color (Rollo pequeño)

Tubo multicamada Henco com manga de proteção corrugada (Rolo)

Article number	Pallet	Type	Pallet dimension
25-016MB-KB	25 m / 600 m	16x2	120x80 cm
25-016MR-KB	25 m / 600 m	16x2	120x80 cm

ID Coil: 28cm



A. STANDARD (PE-Xc/AL/PE-Xc)

1 Type: LB



Henco carcassing pipe Ø 16

Tubo Henco doble curva radiador Ø 16

Tubo multicamada Henco dupla curva radiador Ø 16

Article number	m	Type
LB50	1 m	50 mm

7 Type: ISO-BLOCK-S

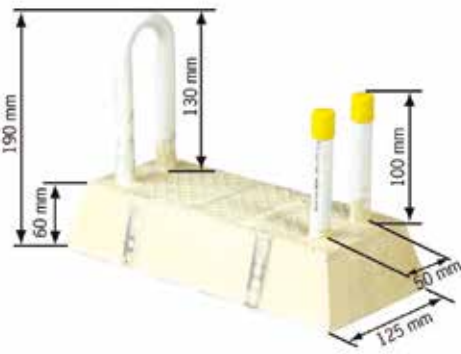

Henco carcassing pipe Ø 16 with insulation

Tubo Henco doble curva radiador Ø 16 con aislamiento

Tubo radiador dupla curva Henco Ø 16 com isolamento

Article number	m	Type
ISO-BLOCK-S	1 m	ISO-BLOCK-S

B. RIXc (PE-Xc/AL/PE-Xc)



Type: COIL



Henco multilayer pipe RIXc (Coil)

Tubo Henco multicapa (Rollo)

Tubo multicamada Henco Normal (Rolo)

Article number	m / Pallet	Type	Pallet dimension
50-R160212	50 m / 1500 m	16x2	160x80 cm
100-R160212	100 m / 2200 m	16x2	75x75 cm
200-R160212	200 m / 2600 m	16x2	75x75 cm
500-R160212D	500 m / 2500 m	16x2	75x75 cm
100-R180214	100 m / 1700 m	18x2	75x75 cm
200-R180214	200 m / 2000 m	18x2	75x75 cm
100-R200216	100 m / 1500 m	20x2	75x75 cm
50-R260320	50 m / 800 m	26x3	75x75 cm

Type: COIL CSC



Henco multilayer pipe RIXc (Coil Small Core)

Tubo Henco multicapa (Rollo pequeño)

Tubo multicamada Henco Normal (pequeno rolo)

Article number	Pallet	Type	Pallet dimension
10-R160212-KB	10 m / 800 m	16x2	120x80 cm
15-R160212-KB	15 m / 900 m	16x2	120x80 cm
25-R160212-KB	25 m / 1125 m	16x2	120x80 cm

ID Coil: 28cm

Type: STRAIGHT LENGTH



Henco multilayer pipe RIXc (Straight length)

Tubo Henco multicapa (Barra)

Tubo multicamada Henco Normal (vara)

Article number	Cylinder / Pallet	Type	Pallet dimension
03-R160212	75 m / 3600 m	16x2	310x75 cm
04-R160212	100 m / 4800 m	16x2	410x75 cm
05-R160212	125 m / 6000 m	16x2	510x75 cm
03-R200216	54 m / 2592 m	20x2	310x75 cm
04-R200216	72 m / 3456 m	20x2	410x75 cm
05-R200216	90 m / 4320 m	20x2	510x75 cm
03-R260320	30 m / 1440 m	26x3	310x75 cm
04-R260320	40 m / 1920 m	26x3	410x75 cm
05-R260320	50 m / 2400 m	26x3	510x75 cm



B. RIXc (PE-Xc/AL/PE-Xc)

1 Type: ISO4 (6 mm)



RIXc Pre-insulated (Coil)

Tubo Henco multicapa preaislado (Rollo)

Tubo pré-isolado RIXc

Article number	m / Pallet	Type	Pallet dimension
100-ISO4-R16-RO	100 m / 1300 m	16x2 red	75x75 cm
100-ISO4-R16-BL	100 m / 1300 m	16x2 blue	75x75 cm
50-ISO4-R16-RO	50 m / 700 m	16x2 red	75x75 cm
50-ISO4-R16-BL	50 m / 700 m	16x2 blue	75x75 cm
25-ISO4-R16-RO	25 m / 250 m	16x2 red	75x75 cm
25-ISO4-R16-BL	25 m / 250 m	16x2 blue	75x75 cm
50-ISO4-R18-RO	50 m / 650 m	18x2 red	75x75 cm
50-ISO4-R18-BL	50 m / 650 m	18x2 blue	75x75 cm
50-ISO4-R20-RO	50 m / 700 m	20x2 red	75x75 cm
50-ISO4-R20-BL	50 m / 700 m	20x2 blue	75x75 cm
25-ISO4-R26-RO	25 m / 300 m	26x3 red	75x75 cm
25-ISO4-R26-BL	25 m / 300 m	26x3 blue	75x75 cm
50-ISO4-R26-RO	50 m / 500 m	26x3 red	75x75 cm
50-ISO4-R26-BL	50 m / 500 m	26x3 blue	75x75 cm

11 Type: ISO9 (10 mm)



RIXc Pre-insulated (Coil)

Tubo Henco multicapa preaislado (Rollo)

Tubo pré-isolado RIXc

Article number	m / Pallet	Type	Pallet dimension
50-ISO9-R16-RO	50 m / 550 m	16x2 red	75x75 cm
50-ISO9-R16-BL	50 m / 550 m	16x2 blue	75x75 cm
50-ISO9-R18-BL	50 m / 650 m	18x2 blue	75x75 cm
50-ISO9-R20-RO	50 m / 500 m	20x2 red	75x75 cm
50-ISO9-R20-BL	50 m / 500 m	20x2 blue	75x75 cm
25-ISO9-R26-RO	25 m / 275 m	26x3 red	75x75 cm
25-ISO9-R26-BL	25 m / 275 m	26x3 blue	75x75 cm
50-ISO9-R26-RO	50 m / 450 m	26x3 red	75x75 cm
50-ISO9-R26-BL	50 m / 450 m	26x3 blue	75x75 cm

Type: ISO13 (13 mm)



RIXc Pre-insulated (Coil)

Tubo Henco multicapa preaislado (Rollo)

Tubo pré-isolado RIXc

Article number	m / Pallet	Type	Pallet dimension
50-ISO13-R16-RO	50 m / 500 m	16x2 red	75x75 cm
50-ISO13-R16-BL	50 m / 500 m	16x2 blue	75x75 cm
50-ISO13-R20-RO	50 m / 400 m	20x2 red	75x75 cm
50-ISO13-R20-BL	50 m / 400 m	20x2 blue	75x75 cm
50-ISO13-R26-RO	50 m / 350 m	26x3 red	75x75 cm
50-ISO13-R26-BL	50 m / 400 m	26x3 blue	75x75 cm

B. RIXc (PE-Xc/AL/PE-Xc)



Type: ISO16 (16 mm)



RIXc Pre-insulated (Coil)

Tubo Henco multicapa preaislado (rollo)

Tubo pré-isolado RIXc

Article number	m / Pallet	Type	Pallet dimension
50-ISO20-R16-RO	50 m / 400 m	16x2 red	75x75 cm
50-ISO20-R16-BL	50 m / 400 m	16x2 blue	75x75 cm

Type: ISO20 (20 mm)



RIXc Pre-insulated (Coil)

Tubo Henco multicapa preaislado (rollo)

Tubo pré-isolado RIXc

Article number	m / Pallet	Type	Pallet dimension
50-ISO20-R20-RO	50 m / 400 m	20x2 red	75x75 cm
50-ISO20-R20-BL	50 m / 400 m	20x2 blue	75x75 cm

Type: ISO26 (26 mm)



RIXc Pre-insulated (Coil)

Tubo Henco multicapa preaislado (rollo)

Tubo pré-isolado RIXc

Article number	m / Pallet	Type	Pallet dimension
25-ISO20-R26-RO	25 m / 250 m	26x3 red	75x75 cm
25-ISO20-R26-BL	25 m / 250 m	26x3 blue	75x75 cm

Type: COMBI ISO4 RIXc (6mm)



Henco Combi iso 6 mm (Coil)

Tubo Henco multicapa Combi ISO 6mm (Rollo)

Henco Combi iso 6mm (Rolo)

Article number	m / Pallet	Type	Pallet dimension
50-ISO4-COMBI16R	50 m / 400 m	16x2	75x75 cm



REPAIR TAPE p 160

1

2

3

4

5

6

7

8

9

10

11

12



C. FLOOR-RIXc (PE-Xc/AL/PE-Xc)

1 Type: RIXc PIPE IN PIPE



RIXc With colour coded conduit (Coil)

Tubo Henco multicapa con corrugado por color (Rollo)

Henco RIXc com manga de proteção corrugada

Article number	m / Pallet	Type	Pallet dimension
25-R16MR	25 m / 500 m	16x2 red	120x80 cm
25-R16MB	25 m / 500 m	16x2 blue	120x80 cm
50-R16MR	50 m / 1000 m	16x2 red	120x80 cm
50-R16MB	50 m / 1000 m	16x2 blue	120x80 cm
50-R16MBLACK	50 m / 1000 m	16x2 black	120x80 cm
100-R16MR	100 m / 1000 m	16x2 red	120x80 cm
100-R16MB	100 m / 1000 m	16x2 blue	120x80 cm
100-R16MBLACK	100 m / 1000 m	16x2 black	120x80 cm
50-R18MR	50 m / 800 m	18x2 red	120x80 cm
50-R18MB	50 m / 800 m	18x2 blue	120x80 cm
25-R20MR	25 m / 500 m	20x2 red	120x80 cm
25-R20MB	25 m / 500 m	20x2 blue	120x80 cm
25-R20MBLACK	25 m / 500 m	20x2 black	120x80 cm
50-R20MR	50 m / 800 m	20x2 red	120x80 cm
50-R20MB	50 m / 800 m	20x2 blue	120x80 cm
100-R20MR	100 m / 1000 m	20x2 red	120x80 cm
100-R20MB	100 m / 1000 m	20x2 blue	120x80 cm
50-R26MR	50 m / 500 m	26x3 red	120x80 cm
50-R26MB	50 m / 500 m	26x3 blue	120x80 cm

Type: COMBI RIXc



Henco Combi (Coil)

Tubo Henco multicapa con corrugado Combi (Rollo)

Henco RIXc combi (Rolo)

Article number	m / Pallet	Type	Pallet dimension
50-COMBI16R	50 m / 800 m	16x2	120x80 cm

Type: FLOOR-RIXc



Henco multilayer pipe (Coil)

Tubo Henco multicapa (Rollo)

Tubo multicamada Henco (Rolo)

Article number	m / Pallet	Type	Pallet dimension
100-F16R-WZ	100 m / 2200 m	16x2	75x75 cm
200-F16R-WZ	200 m / 2600 m	16x2	80x80 cm
500-F16R-WZ	500 m / 2500 m	16x2	75x75 cm
100-F20R-WZ	100 m / 1000 m	20x2	75x75 cm
400-F20R-WZ	400 m / 1200 m	20x2	75x75 cm

6 bar - 60°C



Type: 5L PE-Xc



Henco 5L PE-Xc pipe PE-Xc/EVOH/PE-Xc (Coil)
 Henco 5L PE-Xc tubo PE-Xc/EVOH/PE-Xc (Rollo)
 Henco 5L PE-Xc tubo PE-Xc/EVOH/PE-Xc (Rolo)

Article number	m / Pallet	Type	Pallet dimension
200-PXC1620	200 m / 1600 m	16x2	80x80 cm
600-PXC1620	600 m / 2400 m	16x2	80x80 cm
200-PXC1720	200 m / 2000 m	17x2	80x80 cm
600-PXC1720	600 m / 2400 m	17x2	80x80 cm
240-PXC1820	240 m / 2160 m	18x2	80x80 cm
200-PXC2020	200 m / 1000 m	20x2	80x80 cm
600-PXC2020	600 m / 1200 m	20x2	80x80 cm

1

2

3

4

5

6

7

8

9

10

11

12



E. PE-RT

1 Type: 5L PE-RT



Henco 5L PE-RT pipe PE-RT/EVOH/PE-RT (Coil)
Henco 5L PE-RT tubo PE-RT/EVOH.PE-RT (Rollo)
Henco 5L PE-RT tubo PE-RT/EVOH.PE-RT (Rolo)

Article number	m / Pallet	Type	Pallet dimension
120-PRT1620	120 m / 1440 m	16x2	80x80 cm
200-PRT1620	200 m / 1600 m	16x2	80x80 cm
240-PRT1820	240 m / 1440 m	18x2	80x80 cm
600-PRT1620	600 m / 2400 m	16x2	80x80 cm
600-PRT1720	600 m / 2400 m	17x2	80x80 cm
600-PRT1820	600 m / 1200 m	18x2	80x80 cm
600-PRT2020	600 m / 1800 m	20x2	80x80 cm

F. PROTECTION HOSE



Type: PROTECTION HOSE



Colour coded conduit (Coil)
Corrugado por color (Rollo)
Manga corrugada para GÁS (Rolo)

Article number	m / Pallet	Type	Pallet dimension
100-MR	100 m / 2400 m	Ø14/Ø16/Ø18	120x80 cm
100-MB	100 m / 2400 m	Ø14/Ø16/Ø18 blue	120x80 cm
50-MR20	50 m / 1800 m	Ø20 red	120x80 cm
50-MB20	50 m / 1800 m	Ø20 blue	120x80 cm
50-MR26	50 m / 1200 m	Ø26 red	120x80 cm
50-MB26	50 m / 1200 m	Ø26 blue	120x80 cm
25-MR32	25 m / 1000 m	Ø32 red	120x80 cm
25-MB32	25 m / 1000 m	Ø32 blue	120x80 cm
100-MBLACK	100 m / 2400 m	Ø14/Ø16/Ø18 black	120x80 cm
50-MBLACK20	50 m / 1800 m	Ø20 black	120x80 cm
50-MBLACK26	50 m / 1200 m	Ø26 black	120x80 cm

Type: PROTECTION HOSE GAS



Colour coded conduit (Coil)
Corrugado para gas (Rollo)
Tubo corrugado para GÁS (Rolo)

Article number	m / Pallet	Type	Pallet dimension
50-MG16	50 m / 2400 m	Ø16 yellow	120x80 cm
100-MG16	100 m / 2400 m	Ø16 yellow	120x80 cm
50-MG20	50 m / 1800 m	Ø20 yellow	120x80 cm
50-MG26	50 m / 1200 m	Ø26 yellow	120x80 cm
25-MG32	25 m / 1000 m	Ø32 yellow	120x80 cm



G. GAS STANDARD (PE-Xc/AL/PE-Xc)

1

Gas: only allowed in countries where has been a HENCO GAS testing + certificate is available! (see www.henco.be)
 Gas: solo permitido en países donde se ha realizado una prueba + certificado de HENCO GAS disponible. (ver www.henco.be)
 Gás: permitido apenas em países onde o Henco Gás + o certificado está disponível! (veja www.henco.be)

2

3

4

5

6

7

8

9

10

11

12

Type: COIL



Henco multilayer pipe (Coil)
 Tubo Henco multicapa (Rollo)
 Tubo multicamada Henco (Rolo)

Article number	m / Pallet	Type	Pallet dimension
25-160212-GAS	25 m / 800 m	16x2	75x75 cm
50-160212-GAS	50 m / 1500 m	16x2	120x80 cm
25-200216-GAS	25 m / 800 m	20x2	75x75 cm
50-200216-GAS	50 m / 1000 m	20x2	120x80 cm
50-260320-GAS	50 m / 800 m	26x3	75x75 cm
50-320326-GAS	50 m / 650 m	32x3	90x90 cm

Type: STRAIGHT LENGTH



Henco multilayer pipe (Straight length)
 Tubo Henco multicapa (Barra)
 Tubo multicamada Henco Gás (vara)

Article number	Cylinder / Pallet	Type	Pallet dimension
05-160212-GAS	125 m / 6000 m	16x2	510x70,5 cm
05-200216-GAS	90 m / 4300 m	20x2	510x70,5 cm
05-260320-GAS	50 m / 2400 m	26x3	510x70,5 cm
05-320326-GAS	35 m / 1680 m	32x3	510x70,5 cm
05-403533-GAS	45 m / 1080 m	40x3,5	510x70,5 cm

Type: GAS PIPE IN PIPE



With colour coded conduit (Coil)
 Tubo Henco multicapa con corrugado (Rollo)
 Tubo multicamada Henco Gás (rolo)

Article number	m / Pallet	Typ	Pallet dimension
25-016GASMG	25 m / 500 m	16x2	120x80 cm
50-016GASMG	50 m / 500 m	16x2	120x80 cm
25-020GASMG	25 m / 500 m	20x2	120x80 cm
50-020GASMG	50 m / 800 m	20x2	120x80 cm
25-026GASMG	25 m / 500 m	26x3	120x80 cm
50-026GASMG	50 m / 500 m	26x3	120x80 cm
25-032GASMG	25 m / 300 m	32x3	120x80 cm

Gasteq: Standard pipe gas in combination with Henco press fittings Synthetic for gas, see page 40.

DVGW and Kiwa Uni: Standard pipe gas in combination with Henco brass press fittings for gas, see page 85.





Sprinkler: only allowed in countries where a HENCO Sprinkler certificate is available! (see www.henco.be)
 Sprinkler: solo se permite en países donde hay disponible un certificado de sprinkler HENCO. (ver www.henco.be)
 Sprinkler: permitido apenas em países onde o certificado HENCO Sprinkler está disponível! (veja www.henco.be)

Type: COIL



Henco multilayer pipe (Coil)
Tubo Henco multicapa (Rollo)
Tubo multicamada Henco (Rolo)

Article number	m / Pallet	Type	Pallet dimension
50-260320-SPR	50 m / 1440 m	26 x 3	310x70,5 cm
50-320326-SPR	50 m / 1920 m	32 x 3	410x70,5 cm

Type: Straight length



Henco multilayer pipe (Straight length)
Tubo Henco multicapa (Barra)
Tubo multicamada Henco (vara)

Article number	Cylinder / Pallet	Type	Pallet dimension
05-320326-SPR	35 m / 1680 m	32 x 3	510x70,5 cm
05-403533-SPR	45 m / 1080 m	40 x 3,5	510x70,5 cm
05-504042-SPR	35 m / 840 m	50 x 4	510x70,5 cm
05-634554-SPR	20 m / 480 m	63 x 4,5	510x70,5 cm

Standard pipe Sprinkler in combination with Henco press fittings synthetic for Sprinkler, see page 45
 Sprinkler Cup: see page 50



HENCO PRESS - HENCO PRESS - HENCO PRESS



	<i>Page</i>
A. PK	23
B. PKW	37
C. PKG	45
D. PKS	50
E. SUPER SIZES	56
F. ECOLINE	32



Type: 1PK



Elbow 90°
Codo 90°
Joelho de 90°

Article number	Bag / Box	Type
1PK-1414	10 pc. / 150 pc.	14x14
1PK-1616	10 pc. / 120 pc.	16x16
1PK-1818	10 pc. / 100 pc.	18x18
1PK-2020	10 pc. / 80 pc.	20x20
1PK-2626	5 pc. / 50 pc.	26x26
1PK-3232	5 pc. / 30 pc.	32x32
1PK-4040	5 pc. / 20 pc.	40x40
1PK-5050	1 pc. / 8 pc.	50x50
1PK-6363	1 pc. / 6 pc.	63X63

Article number	Box	Type
1PK-7575	1 pc.	75x75
1PK-9090	1 pc.	90x90

For the composition of Super Sizes, see p. 56

Type: 1PK-JG



Elbow 90° 16x10JG (ceiling cooling)
Codo 90° 16xJG10
Joelho de 90° 16xJG10

Article number	Bag / Box	Type
1PK-16JG10	10 pc. / 120 pc.	16x10JG
1PK-20JG10	10 pc. / 100 pc.	20x10JG

Type: 2PK



Backplate elbow female
Codo con soporte, rosca hembra
Joelho com suporte, rosca fêmea

Article number	Bag / Box	Type
2PK-1404BP*	10 pc. / 50 pc.	14x1/2" (56 mm)
2PK-1603	10 pc. / 50 pc.	16x3/8" (56 mm)
2PK-1604BP*	10 pc. / 50 pc.	16x1/2" (56 mm)
2PK-1804BP*	10 pc. / 50 pc.	18x1/2" (56 mm)
2PK-2004BP*	10 pc. / 50 pc.	20x1/2" (56 mm)
2PK-2005	5 pc. / 30 pc.	20x3/4" (56 mm)
2PK-2605	5 pc. / 30 pc.	26x3/4" (56 mm)

** With black plug BP04 1/2"*

Type: 2PK-X (INOX)



Backplate elbow female
Codo con soporte, rosca hembra
Joelho com suporte, fio fêmea

Article number	Bag / Box	Type
2PK-1404-X	10 pc. / 50 pc.	14x1/2" (56 mm)
2PK-1604-X	10 pc. / 50 pc.	16x1/2" (56 mm)
2PK-1804-X	10 pc. / 50 pc.	18x1/2" (56 mm)
2PK-2004-X	10 pc. / 50 pc.	20x1/2" (56 mm)
2PK-2005-X	5 pc. / 30 pc.	20x3/4" (56 mm)
2PK-2605-X	5 pc. / 30 pc.	26x3/4" (56 mm)



A. PK

Type: 2PK-K



Backplate elbow female, short model
Codo con soporte, rosca hembra, corto
Joelho com pater, rosca fêmea, curto

Article number	Bag / Box	Type
2PK-1604KBP*	10 pc. / 50 pc.	16x1/2" (40 mm)

* With black plug BP04 1/2"

Accessory 2PK & 2PK-K: galvanised bracket plate - see page 160



PLP-P-PK



PLF-P-PK

Type: 3PK



Double backplate elbow female, short model
Doble Codo con soporte, rosca hembra, corto
Joelho duplo com pater, rosca fêmea, curto

Article number	Bag / Box	Type
3PK-160416BP*	10 pc. / 30 pc.	16x1/2"x16 (40 mm)
3PK-200420BP*	10 pc. / 30 pc.	20x1/2"x20 (40 mm)
3PK-200420-X	10 pc. / 30 pc.	20x1/2"x20 (40 mm)

* With black plug BP04 1/2"

Type: 3PK-X (INOX)



Double backplate elbow female, short model
Doble Codo con soporte, rosca hembra, corto
Joelho duplo com suporte, rosca fêmea, curto

Article number	Bag / Box	Type
3PK-160416-X	10 pc. / 30 pc.	16x1/2"x16 (40 mm)

Type: BP04



Black plug for 1/2" female nipple
Tapón negro para racor rosca hembra de 1/2"
Tampa preta para encaixe roscado fêmea de 1/2"

Article number	Bag / Box	Type
BP04	50 pc. / 500 pc.	1/2"



Type: 5PK (CW617)



Bend 90° male adapter

Codo 90° macho

Joelho macho de 90°

Article number	Bag / Box	Type
5PK-1404	10 pc. / 60 pc.	14x1/2"
5PK-1604	10 pc. / 60 pc.	16x1/2"
5PK-1804	10 pc. / 60 pc.	18x1/2"
5PK-2004	10 pc. / 60 pc.	20x1/2"
5PK-2005	10 pc. / 50 pc.	20x3/4"
5PK-2605	10 pc. / 40 pc.	26x3/4"
5PK-3206	5 pc. / 20 pc.	32x1"
5PK-4007	3 pc. / 15 pc.	40x1 1/4"
5PK-5007	1 pc. / 10 pc.	50x1 1/4"
5PK-5008	1 pc. / 8 pc.	50x1 1/2"
5PK-6310	1 pc. / 4 pc.	63x2"

Article number	Box	Type
5PK-7510	1 pc.	75x2"
5PK-7512	1 pc.	75x2 1/2"

For the composition of Super Sizes, see p. 56

Type: 5PK-N (CW602)



Bend 90° male adapter

Codo 90° macho

Joelho macho de 90°

Article number	Bag / Box	Type
5PK-4007-N	3 pc. / 15 pc.	40x1 1/4"
5PK-5007-N	1 pc. / 10 pc.	50x1 1/4"
5PK-5008-N	1 pc. / 8 pc.	50x1 1/2"
5PK-6310-N	1 pc. / 4 pc.	63x2"

Type: 6PK (CW617)



Bend 90° female adapter

Codo 90° rosca hembra

Joelho com rosca fêmea de 90°

Article number	Bag / Box	Type
6PK-1404BP*	10 pc. / 60 pc.	14x1/2"
6PK-1603	10 pc. / 60 pc.	16x3/8"
6PK-1604BP*	10 pc. / 60 pc.	16x1/2"
6PK-1804BP*	10 pc. / 60 pc.	18x1/2"
6PK-2004BP*	10 pc. / 60 pc.	20x1/2"
6PK-2005	10 pc. / 50 pc.	20x3/4"
6PK-2605	10 pc. / 50 pc.	26x3/4"
6PK-3206	5 pc. / 20 pc.	32x1"
6PK-4007	5 pc. / 15 pc.	40x1 1/4"
6PK-5007	1 pc. / 8 pc.	50x1 1/4"
6PK-5008	1 pc. / 8 pc.	50x1 1/2"
6PK-6310	1 pc. / 4 pc.	63x2"

**/INOX

Article number	Box	Type
6PK-7506	1 pc.	75x1"
6PK-7510	1 pc.	75x2"
6PK-7512	1 pc.	75x2 1/2"
6PK-9014	1 pc.	90x3"

For the composition of Super Sizes, see p. 56



A. PK

Type: 6PK-X (INOX)



Bend 90° female adapter

Codo 90° rosca hembra

Joelho rosca fêmea 90°

Article number	Bag / Box	Type
6PK-1404-X	10 pc. / 60 pc.	14x1/2"
6PK-1604-X	10 pc. / 60 pc.	16x1/2"
6PK-1804-X	10 pc. / 60 pc.	18x1/2"
6PK-2004-X	10 pc. / 60 pc.	20x1/2"
6PK-2005-X	10 pc. / 50 pc.	20x3/4"
6PK-2605-X	10 pc. / 50 pc.	26x3/4"
6PK-3206-X	5 pc. / 20 pc.	32x1"
6PK-4007-X	5 pc. / 15 pc.	40x1 1/4"
6PK-5007-X	1 pc. / 8 pc.	50x1 1/4"
6PK-5008-X	1 pc. / 8 pc.	50x1 1/2"
6PK-6310-X	1 pc. / 4 pc.	63x2"

Type: 6PK-N (CW602)



Bend 90° female adapter

Codo 90° rosca hembra

Joelho rosca fêmea 90°

Article number	Bag / Box	Type
6PK-4007-N	5 pc. / 15 pc.	40x1 1/4"
6PK-5007-N	1 pc. / 8 pc.	50x1 1/4"
6PK-5008-N	1 pc. / 8 pc.	50x1 1/2"
6PK-6310-N	1 pc. / 4 pc.	63x2"

Type: 9PK



T-piece

Te

Tê

Article number	Bag / Box	Type
9PK-141414	10 pc. / 100 pc.	14x14x14
9PK-161616	10 pc. / 60 pc.	16x16x16
9PK-181818	10 pc. / 60 pc.	18x18x18
9PK-202020	10 pc. / 50 pc.	20x20x20
9PK-262626	5 pc. / 30 pc.	26x26x26
9PK-323232	5 pc. / 15 pc.	32x32x32
9PK-404040	5 pc. / 10 pc.	40x40x40
9PK-505050	1 pc. / 6 pc.	50x50x50
9PK-636363	1 pc. / 3 pc.	63x63x63

Article number	Box	Type
9PK-757575	1 pc.	75x75x75
9PK-909090	1 pc.	90x90x90

For the composition of Super Sizes, see p. 56



Type: 10PK



T-reduced centre

Té reducida

Tê de redução

Article number	Bag / Box	Type
10PK-161416	10 pc. / 50 pc.	16x14x16
10PK-181418	10 pc. / 50 pc.	18x14x18
10PK-181618	10 pc. / 50 pc.	18x16x18
10PK-201420	10 pc. / 50 pc.	20x14x20
10PK-201620	10 pc. / 50 pc.	20x16x20
10PK-201820	10 pc. / 50 pc.	20x18x20
10PK-261626	5 pc. / 30 pc.	26x16x26
10PK-261826	5 pc. / 30 pc.	26x18x26
10PK-262026	5 pc. / 30 pc.	26x20x26
10PK-321632	5 pc. / 25 pc.	32x16x32
10PK-321832	5 pc. / 25 pc.	32x18x32
10PK-322032	5 pc. / 25 pc.	32x20x32
10PK-322632	5 pc. / 20 pc.	32x26x32
10PK-401640	5 pc. / 15 pc.	40x16x40
10PK-402040	5 pc. / 15 pc.	40x20x40
10PK-402640	5 pc. / 15 pc.	40x26x40
10PK-403240	5 pc. / 10 pc.	40x32x40
10PK-502050	1 pc. / 6 pc.	50x20x50
10PK-502650	1 pc. / 8 pc.	50x26x50
10PK-503250	1 pc. / 8 pc.	50x32x50
10PK-504050	1 pc. / 6 pc.	50x40x50
10PK-632663	1 pc. / 4 pc.	63x26x63
10PK-633263	1 pc. / 3 pc.	63x32x63
10PK-634063	1 pc. / 3 pc.	63x40x63
10PK-635063	1 pc. / 3 pc.	63x50x63



Article number	Box	Type
10PK-753275	1 pc.	75x32x75
10PK-754075	1 pc.	75x40x75
10PK-755075	1 pc.	75x50x75
10PK-756375	1 pc.	75x63x75
10PK-903290	1 pc.	90x32x90
10PK-904090	1 pc.	90x40x90
10PK-905090	1 pc.	90x50x90
10PK-906390	1 pc.	90x63x90
10PK-907590	1 pc.	90x75x90

For the composition of Super Sizes, see p. 57

Type: 10PK-JG



T-reduced centre 16x10JGx16 (ceiling cooling)

Te-centro reducido 16x10JGx16 (refrigeración de techo)

Tê de redução ao centro

Article number	Bag / Box	Type
10PK-16JG1016	10 pc. / 50 pc.	16x10JGx16
10PK-20JG1020	10 pc. / 50 pc.	20x10JGx20



A. PK

Type: 11PK



T-branch and line reduced

Te reducida

Tê de redução

Article number	Bag / Box	Type
11PK-161414	10 pc. / 50 pc.	16x14x14
11PK-181616	10 pc. / 50 pc.	18x16x16
11PK-201616	10 pc. / 50 pc.	20x16x16
11PK-201818	10 pc. / 50 pc.	20x18x18
11PK-202016	10 pc. / 50 pc.	20x20x16
11PK-261616	10 pc. / 50 pc.	26x16x16
11PK-261620	5 pc. / 30 pc.	26x16x20
11PK-262016	5 pc. / 30 pc.	26x20x16
11PK-262020	5 pc. / 30 pc.	26x20x20
11PK-262616	5 pc. / 30 pc.	26x26x16
11PK-262620	5 pc. / 30 pc.	26x26x20
11PK-322026	5 pc. / 20 pc.	32x20x26
11PK-322626	5 pc. / 20 pc.	32x26x26
11PK-402032	5 pc. / 15 pc.	40x20x32
11PK-402632	5 pc. / 15 pc.	40x26x32
11PK-403232	5 pc. / 10 pc.	40x32x32
11PK-404026	5 pc. / 10 pc.	40x40x26
11PK-404032	5 pc. / 10 pc.	40x40x32
11PK-502040	1 pc. / 10 pc.	50x20x40
11PK-502640	1 pc. / 10 pc.	50x26x40
11PK-503240	1 pc. / 10 pc.	50x32x40
11PK-504040	1 pc. / 8 pc.	50x40x40



Article number	Box	Type
11PK-753232	1 pc.	75x32x32
11PK-753240	1 pc.	75x32x40
11PK-753250	1 pc.	75x32x50
11PK-753263	1 pc.	75x32x63
11PK-753275	1 pc.	75x32x75
11PK-754040	1 pc.	75x40x40
11PK-754050	1 pc.	75x40x50
11PK-754063	1 pc.	75x40x63
11PK-755050	1 pc.	75x50x50
11PK-755063	1 pc.	75x50x63
11PK-756363	1 pc.	75x63x63
11PK-903232	1 pc.	90x32x32
11PK-903240	1 pc.	90x32x40
11PK-903250	1 pc.	90x32x50
11PK-903263	1 pc.	90x32x63
11PK-903275	1 pc.	90x32x75
11PK-903290	1 pc.	90x32x90
11PK-904040	1 pc.	90x40x40
11PK-904050	1 pc.	90x40x50
11PK-904063	1 pc.	90x40x63
11PK-904075	1 pc.	90x40x75
11PK-905050	1 pc.	90x50x50
11PK-905063	1 pc.	90x50x63
11PK-905075	1 pc.	90x50x75
11PK-906363	1 pc.	90x63x63
11PK-906375	1 pc.	90x63x75
11PK-907575	1 pc.	90x75x75

For the composition of Super Sizes, see p. 57



Type: 12PK



T-enlarged branch
Te, ampliación centro
Tê de aumento central

Article number	Bag / Box	Type
12PK-161816	10 pc. / 50 pc.	16x18x16
12PK-162016	10 pc. / 50 pc.	16x20x16
12PK-202620	5 pc. / 30 pc.	20x26x20
12PK-263226	5 pc. / 20 pc.	26x32x26
12PK-324032	5 pc. / 15 pc.	32x40x32
12PK-405040	1 pc. / 8 pc.	40x50x40

Article number	Box	Type
12PK-327532	1 pc.	32x75x32
12PK-329032	1 pc.	32x90x32
12PK-407540	1 pc.	40x75x40
12PK-507550	1 pc.	50x75x50
12PK-637563	1 pc.	63x75x63
12PK-409040	1 pc.	40x90x40
12PK-509050	1 pc.	50x90x50
12PK-639063	1 pc.	63x90x63
12PK-759075	1 pc.	75x90x75

For the composition of Super Sizes, see p. 57

Type: 13PK (CW617)



PK-TOOL p 157



T-female centre
Te, rosca hembra centro
Tê fêmea rosca centro

Article number	Bag / Box	Type
13PK-160416BP*	10 pc. / 50 pc.	16x1/2"x16
13PK-180418BP*	10 pc. / 50 pc.	18x1/2"x18
13PK-200420BP*	10 pc. / 50 pc.	20x1/2"x20
13PK-200520	10 pc. / 30 pc.	20x3/4"x20
13PK-260420BP*	5 pc. / 30 pc.	26x1/2"x20
13PK-260426BP*	5 pc. / 30 pc.	26x1/2"x26
13PK-260526	5 pc. / 30 pc.	26x3/4"x26
13PK-320532	5 pc. / 15 pc.	32x3/4"x32
13PK-320632	5 pc. / 10 pc.	32x1"x32
13PK-320732	5 pc. / 10 pc.	32x1 1/4"x32
13PK-400540	5 pc. / 10 pc.	40x3/4"x4
13PK-400640	5 pc. / 10 pc.	40x1"x40
13PK-400740	5 pc. / 10 pc.	40x1 1/4"x40
13PK-500550	1 pc. 6 pc.	50x3/4"x50
13PK-500850	1 pc. / 4 pc.	50x1 1/2"x50
13PK-631063	1 pc. / 2 pc.	63x2"x63

* With black plug BP04 1/2" **INOX

Article number	Box	Type
13PK-750675	1 pc.	75x1"x75
13PK-751075	1 pc.	75x2"x75
13PK-751275	1 pc.	75x2 1/2"x75
13PK-901490	1 pc.	90x3"x90

For the composition of Super Sizes, see p. 58



A. PK

Type: 13PK-X (INOX)



T-female centre
Te, rosca hembra centro
Tê fêmea rosca centro

Artikelnummer	Doos	Type
13PK-160416-X	10 pc. / 50 pc.	16x1/2"x16
13PK-180418-X	10 pc. / 50 pc.	18x1/2"x18
13PK-200420-X	10 pc. / 50 pc.	20x1/2"x20
13PK-200520-X	10 pc. / 30 pc.	20x3/4"x20
13PK-260420-X	5 pc. / 30 pc.	26x1/2"x20
13PK-260426-X	5 pc. / 30 pc.	26x1/2"x26
13PK-260526-X	5 pc. / 30 pc.	26x3/4"x26
13PK-320532-X	5 pc. / 15 pc.	32x3/4"x32
13PK-320632-X	5 pc. / 10 pc.	32x1"x32
13PK-320732-X	5 pc. / 10 pc.	32x1 1/4"x32
13PK-400540-X	5 pc. / 10 pc.	40x3/4"x4
13PK-400640-X	5 pc. / 10 pc.	40x1"x40
13PK-400740-X	5 pc. / 10 pc.	40x1 1/4"x40
13PK-500550-X	1 pc. 6 pc.	50x3/4"x50
13PK-500850-X	1 pc. / 4 pc.	50x1 1/2"x50
13PK-631063-X	1 pc. / 2 pc.	63x2"x63

Type: 13PK-N (CW602)



PK-TOOL p 157

T-female centre
Te, rosca hembra centro
Tê fêmea rosca centro

Article number	Bag / Box	Type
13PK-400540-N	5 pc. / 10 pc.	40x1/2"x40
13PK-400640-N	5 pc. / 10 pc.	40x1"x40
13PK-400740-N	5 pc. / 10 pc.	40x1 1/4"x40
13PK-500550-N	1 pc. 6 pc.	50x3/4"x50
13PK-500850-N	1 pc. / 4 pc.	50x1 1/2"x50
13PK-631063-N	1 pc. / 2 pc.	63x2"x63

Type: 14PK (CW617)



PK-TOOL p 157

T-male centre
Te rosca macho centro
Tê, macho centro

Article number	Bag / Box	Type
14PK-160416	10 pc. / 50 pc.	16x1/2"x16
14PK-180418	10 pc. / 50 pc.	18x1/2"x18
14PK-200420	10 pc. / 40 pc.	20x1/2"x20
14PK-200520	10 pc. / 30 pc.	20x3/4"x20
14PK-260426	5 pc. / 30 pc.	26x1/2"x26
14PK-260526	5 pc. / 25 pc.	26x3/4"x26
14PK-260626	5 pc. / 20 pc.	26x1"x26
14PK-320532	5 pc. / 15 pc.	32x3/4"x32
14PK-400640	5 pc. / 10 pc.	40x1"x40
14PK-400740	5 pc. / 10 pc.	40x1 1/4"x40
14PK-500850	1 pc. / 5 pc.	50x1 1/2"x50
14PK-631063	1 pc. / 2 pc.	63x2"x63

Article number	Box	Type
14PK-751075	1 pc.	75x2"x75
14PK-751275	1 pc.	75x2 1/2"x75



Type: 14PK-N (CW602)



PK-TOOL p 157

T-male centre
Te rosca macho centro
Tê, macho centro

Article number	Bag / Box	Type
14PK-400640-N	5 pc. / 10 pc.	40x1"x40
14PK-400740-N	5 pc. / 10 pc.	40x1 1/4"x40
14PK-500850-N	1 pc. / 5 pc.	50x1 1/2"x50
14PK-631063-N	1 pc. / 2 pc.	63x2"x63

Type: 15PK



Straight coupling
Manguito
União

Article number	Bag / Box	Type
15PK-1414	10 pc. / 150 pc.	14x14
15PK-1616	10 pc. / 150 pc.	16x16
15PK-1818	10 pc. / 100 pc.	18x18
15PK-2020	10 pc. / 80 pc.	20x20
15PK-2626	5 pc. / 50 pc.	26x26
15PK-3232	5 pc. / 30 pc.	32x32
15PK-4040	5 pc. / 25 pc.	40x40
15PK-5050	1 pc. / 12 pc.	50x50
15PK-6363	1 pc. / 9 pc.	63x63

Article number	Box	Type
15PK-7575	1 pc.	75x75
15PK-9090	1 pc.	90x90

For the composition of Super Sizes, see p. 58

- 1
- 2
- 3
- 4
- 5
- 6
- 7
- 8
- 9
- 10
- 11
- 12



A. PK

Type: 16PK

1

2

3

4

5

6

7

8

9

10

11

12



Reducing coupling Manguito reducción União de redução

Article number	Bag / Box	Type
16PK-1614	10 pc. / 100 pc.	16x14
16PK-1814	10 pc. / 100 pc.	18x14
16PK-1816	10 pc. / 100 pc.	18x16
16PK-2014	10 pc. / 100 pc.	20x14
16PK-2016	10 pc. / 100 pc.	20x16
16PK-2018	10 pc. / 100 pc.	20x18
16PK-2616	5 pc. / 60 pc.	26x16
16PK-2618	5 pc. / 50 pc.	26x18
16PK-2620	5 pc. / 50 pc.	26x20
16PK-3216	5 pc. / 50 pc.	32x16
16PK-3220	5 pc. / 40 pc.	32x20
16PK-3226	5 pc. / 40 pc.	32x26
16PK-4026	5 pc. / 30 pc.	40x26
16PK-4032	5 pc. / 25 pc.	40x32
16PK-5032	1 pc. / 15 pc.	50x32
16PK-5040	1 pc. / 15 pc.	50x40
16PK-6340	1 pc. / 8 pc.	63x40
16PK-6350	1 pc. / 8 pc.	63x50

Article number	Box	Type
16PK-7532	1 pc.	75x32
16PK-7540	1 pc.	75x40
16PK-7550	1 pc.	75x50
16PK-7563	1 pc.	75x63
16PK-9032	1 pc.	90x32
16PK-9040	1 pc.	90x40
16PK-9050	1 pc.	90x50
16PK-9063	1 pc.	90x63
16PK-9075	1 pc.	90x75

For the composition of Super Sizes, see p. 58



Type: 17PK (CW617)



PK-TOOL p 157



Straight male adapter

Racor recto macho

União de transição macho

Article number	Bag / Box	Type
17PK-1404	10 pc. / 80 pc.	14x1/2"
17PK-1604	10 pc. / 80 pc.	16x1/2"
17PK-1804	10 pc. / 80 pc.	18x1/2"
17PK-1805	10 pc. / 50 pc.	18x3/4"
17PK-2004	10 pc. / 80 pc.	20x1/2"
17PK-2005	10 pc. / 50 pc.	20x3/4"
17PK-2605	10 pc. / 50 pc.	26x3/4"
17PK-2606	10 pc. / 40 pc.	26x1"
17PK-3206	10 pc. / 40 pc.	32x1"
17PK-3207	5 pc. / 25 pc.	32x1 1/4"
17PK-4006	5 pc. / 25 pc.	40x1"
17PK-4007	5 pc. / 25 pc.	40x1 1/4"
17PK-5008	1 pc. / 10 pc.	50x1 1/2"
17PK-6310	1 pc. / 6 pc.	63x2"

Article number	Box	Type
17PK-7510	See page 54	75x2"
17PK-7512	See page 54	75x2 1/2"

For the composition of Super Sizes, see p. 59

Type: 17PK-N (CW602)



PK-TOOL p 157

Straight male adapter

Racor recto macho

União de transição macho

Article number	Bag / Box	Type
17PK-4006-N	5 pc. / 25 pc.	40x1"
17PK-4007-N	5 pc. / 25 pc.	40x1 1/4"
17PK-5008-N	1 pc. / 10 pc.	50x1 1/2"
17PK-6310-N	1 pc. / 6 pc.	63x2"



A. PK

Type: 18PK (CW617)



PK-TOOL p 157



Straight female adapter

Racor hembra recto

União de transição fêmea

Article number	Bag / Box	Type
18PK-1404	10 pc. / 80 pc.	14x1/2"
18PK-1604	10 pc. / 80 pc.	16x1/2"
18PK-1804	10 pc. / 80 pc.	18x1/2"
18PK-1805	10 pc. / 50 pc.	18x3/4"
18PK-2004	10 pc. / 80 pc.	20x1/2"
18PK-2005	10 pc. / 50 pc.	20x3/4"
18PK-2605	10 pc. / 50 pc.	26x3/4"
18PK-2606	10 pc. / 40 pc.	26x1"
18PK-3206	10 pc. / 40 pc.	32x1"
18PK-3207	5 pc. / 25 pc.	32x1 1/4"
18PK-4006	5 pc. / 25 pc.	40x1"
18PK-4007	5 pc. / 25 pc.	40x1 1/4"
18PK-5008	1 pc. / 10 pc.	50x1 1/2"
18PK-6310	1 pc. / 6 pc.	63x2"

**INOX

Article number	Box	Type
18PK-7506	1 pc.	75x1"
18PK-7510	1 pc.	75x2"
18PK-7512	1 pc.	75x2 1/2"
18PK-9014	1 pc.	90x3"

For the composition of Super Sizes, see p. 52

Type: 18PK-X (INOX)



Straight female adapter

Raccord hembra recto

União de transição fêmea

Article number	Bag / Box	Type
18PK-1604-X	10 pc. / 80 pc.	16x1/2"
18PK-1804-X	10 pc. / 80 pc.	18x1/2"
18PK-1805-X	10 pc. / 50 pc.	18x3/4"
18PK-2004-X	10 pc. / 80 pc.	20x1/2"
18PK-2005-X	10 pc. / 50 pc.	20x3/4"
18PK-2605-X	10 pc. / 50 pc.	26x3/4"
18PK-2606-X	10 pc. / 40 pc.	26x1"
18PK-3206-X	10 pc. / 40 pc.	32x1"
18PK-3207-X	5 pc. / 25 pc.	32x1 1/4"
18PK-4006-X	5 pc. / 25 pc.	40x1"
18PK-4007-X	5 pc. / 25 pc.	40x1 1/4"
18PK-5008-X	1 pc. / 10 pc.	50x1 1/2"
18PK-6310-X	1 pc. / 6 pc.	63x2"

Type: 18PK-N (CW602)



PK-TOOL p 157

Straight female adapter

Racor hembra recto

União de transição fêmea

Article number	Bag / Box	Type
18PK-4006-N	5 pc. / 25 pc.	40x1"
18PK-4007-N	5 pc. / 25 pc.	40x1 1/4"
18PK-5008-N	1 pc. / 10 pc.	50x1 1/2"
18PK-6310-N	1 pc. / 6 pc.	63x2"



Type: 19PK



Press fit with swivel to eurocone
 Racor eurocono roscado recto
 União de transição roscado Eurocone

Article number	Bag / Box	Type
19PK-1605	10 pc. / 80 pc.	16x3/4"
19PK-2005	10 pc. / 80 pc.	20x3/4"

Type: 26PK



Press fitting with swivel and flat sealing
 Racor a presión con junta giratoria y plana
 União de transição roscado estanque

Article number	Bag / Box	Type
26PK-1605	10 pc. / 80 pc.	16x3/4"
26PK-2005	10 pc. / 80 pc.	20x3/4"

Type: 26PK (CW617)



Press fitting with swivel and flat sealing
 Racor roscado con estanqueidad
 União de transição com porca louca estanque

Article number	Bag / Box	Type
26PK-4008	5 pc. / 15 pc.	40x1 1/2"
26PK-5010	1 pc. / 10 pc.	50x2"
26PK-6312	1 pc. / 6 pc.	63x2 1/2"

Type: 27PK



45° bend
 Codo 45°
 Joelho de 45°

Article number	Bag / Box	Type
27PK-2626	5 pc. / 50 pc.	26x26
27PK-3232	5 pc. / 30 pc.	32x32
27PK-4040	5 pc. / 25 pc.	40x40
27PK-5050	1 pc. / 10 pc.	50x50
27PK-6363	1 pc. / 5 pc.	63x63

Article number	Box	Type
27PK-7575	1 pc.	75x75
27PK-9090	1 pc.	90x90

For the composition of Super Sizes, see p. 52

- 1
- 2
- 3
- 4
- 5
- 6
- 7
- 8
- 9
- 10
- 11
- 12



A. PK

1 Type: 28PK-04

2



Bracket wallplate for 2PK, 6PK and 13PK, interaxis 153mm
Soporte de placa de pared para 2PK, 6PK y 13PK, intereje 153 mm
Chave para 2PK, 6PK e 13PK

Article number	Box	Type
28PK-04	50 pc.	1/2"

3

4

5

6

7

8 Type: 53PK

9

10

11

12



Easy mounting/repair fitting
Accesorio manguito de reparación
Acessório de reparação de fácil montagem

Article number	Bag / Box	Type
53PK40	1 pc. / 20 pc.	40x40
53PK50	1 pc. / 9 pc.	50x50
53PK63	1 pc. / 6 pc.	63x63

for Ø16, 20, 26 and 32: chapter 4, article 52P



Type: 1PKW



Elbow 90°

Codo 90°

Tê de 90°

Article number	Bag / Box	Type
1PKW-1616	10 pc. / 120 pc.	16x16
1PKW-2020	10 pc. / 80 pc.	20x20
1PKW-2626	5 pc. / 50 pc.	26x26
1PKW-3232	5 pc. / 30 pc.	32x32

Type: 2PKW (CW617)



Backplate elbow female

Codo con soporte, rosca hembra

Joelho com pater, rosca fêmea

Article number	Bag / Box	Type
2PKW-1604	10 pc. / 50 pc.	16x1/2" (56 mm)
2PKW-2004	10 pc. / 50 pc.	20x1/2" (56 mm)
2PKW-2005	5 pc. / 30 pc.	20x3/4" (56 mm)
2PKW-2605	5 pc. / 30 pc.	26x3/4" (56 mm)

Type: 2PKW-X (INOX)



Backplate elbow female

Codo con soporte, rosca hembra

Joelho com pater, rosca fêmea

Article number	Bag / Box	Type
2PKW-2004-X	10 pc. / 50 pc.	20x1/2" (56 mm)
2PKW-2005-X	5 pc. / 30 pc.	20x3/4" (56 mm)
2PKW-2605-X	5 pc. / 30 pc.	26x3/4" (56 mm)

Type: 2PKW-N (CW602)



Backplate elbow female

Codo con soporte, rosca hembra

Joelho com suporte, rosca fêmea

Article number	Bag / Box	Type
2PKW-1604-N	10 pc. / 50 pc.	16x1/2" (56 mm)
2PKW-2004-N	10 pc. / 50 pc.	20x1/2" (56 mm)
2PKW-2005-N	5 pc. / 30 pc.	20x3/4" (56 mm)
2PKW-2605-N	5 pc. / 30 pc.	26x3/4" (56 mm)

Type: 2PKW-K (CW617)



Backplate elbow female, short model

Codo con soporte, rosca hembra, corto

Joelho com pater rosca fêmea modelo curto

Article number	Bag / Box	Type
2PKW-1604K	10 pc. / 50 pc.	16x1/2" (40 mm)

Type: 2PKW-K-X (INOX)



Backplate elbow female, short model

Codo con soporte, rosca hembra, corto

Joelho com pater rosca fêmea modelo curto

Article number	Bag / Box	Type
2PKW-1604K-X	10 pc. / 50 pc.	16x1/2" (40 mm)



B. PKW

Type: 2PKW-K-N (CW602)



Backplate elbow female, short model,
Codo con soporte, rosca hembra, corto
Joelho com pater rosca fêmea, modelo curto

Article number	Bag / Box	Type
2PKW-1604K-N	10 pc. / 50 pc.	16x1/2" (40 mm)

Accessory 2PKW, 2PKW-N, 2PKW-K: galvanised bracket plate - see page 160

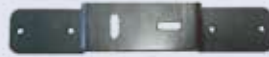

PLP-P-PK



PLF-P-PK

Type: 2PKW-X (INOX)



Backplate elbow female, short model,
Codo con soporte, rosca hembra, corto
Joelho com pater rosca fêmea, modelo curto

Article number	Bag / Box	Type
2PKW-1604-X	10 pc. / 50 pc.	16x1/2" (40 mm)

Type: 3PKW (CW617)



Double backplate elbow female, short model
Doble Codo con soporte, rosca hembra, corto
Joelho duplo com rosca fêmea, modelo curto

Article number	Bag / Box	Type
3PKW-160416	10 pc. / 30 pc.	16x1/2"x16 (40 mm)
3PKW-200420	10 pc. / 30 pc.	20x1/2"x20 (40 mm)

Type: 3PKW-K-X (INOX)



Double backplate elbow female, short model
Doble Codo con soporte, rosca hembra, corto
Joelho duplo com rosca fêmea, modelo curto

Article number	Bag / Box	Type
3PKW-160416-X	10 pc. / 30 pc.	16x1/2"x16 (40 mm)
3PKW-200420-X	10 pc. / 30 pc.	20x1/2"x20 (40 mm)

Type: 3PKW-N (CW602)



Double backplate elbow female, short model
Doble Codo con soporte, rosca hembra, corto
Joelho duplo com rosca fêmea, modelo curto

Article number	Bag / Box	Type
3PKW-160416-N	10 pc. / 30 pc.	16x1/2"x16 (40 mm)
3PKW-200420-N	10 pc. / 30 pc.	20x1/2"x20 (40 mm)



Type: 5PKW (CW617)



PK-TOOL p 157

Bend 90° male adapter
Codo 90° rosca macho
Joelho rosca macho 90°

Article number	Bag / Box	Type
5PKW-1604	10 pc. / 60 pc.	16x1/2"
5PKW-2004	10 pc. / 60 pc.	20x1/2"
5PKW-2005	10 pc. / 50 pc.	20x3/4"
5PKW-2605	10 pc. / 40 pc.	26x3/4"
5PKW-3206	5 pc. / 20 pc.	32x1"

Type: 5PKW-N (CW602)



PK-TOOL p 157

Bend 90° male adapter
Codo 90° rosca macho
Joelho rosca macho 90°

Article number	Bag / Box	Type
5PKW-1604-N	10 pc. / 60 pc.	16x1/2"
5PKW-2004-N	10 pc. / 60 pc.	20x1/2"
5PKW-2005-N	10 pc. / 50 pc.	20x3/4"
5PKW-2605-N	10 pc. / 40 pc.	26x3/4"
5PKW-3206-N	5 pc. / 20 pc.	32x1"

Type: 6PKW (CW617)



PK-TOOL p 157

Bend 90° female adapter
Codo 90° rosca hembra
Joelho rosca fêmea 90°

Article number	Bag / Box	Type
6PKW-1603	10 pc. / 60 pc.	16x3/8"
6PKW-1604	10 pc. / 60 pc.	16x1/2"
6PKW-2004	10 pc. / 60 pc.	20x1/2"
6PKW-2005	10 pc. / 50 pc.	20x3/4"
6PKW-2605	10 pc. / 50 pc.	26x3/4"
6PKW-3206	5 pc. / 20 pc.	32x1"

Type: 6PKW-X (INOX)



Bend 90° female adapter
Codo 90° rosca hembra
Joelho rosca fêmea 90°

Article number	Bag / Box	Type
6PKW-1604-X	10 pc. / 60 pc.	16x1/2"
6PKW-2004-X	10 pc. / 60 pc.	20x1/2"
6PKW-2005-X	10 pc. / 50 pc.	20x3/4"
6PKW-2605-X	10 pc. / 50 pc.	26x3/4"
6PKW-3206-X	5 pc. / 20 pc.	32x1"



B. PKW

Type: 6PKW-N (CW602)



PK-TOOL p 157

Bend 90° female adapter
Codo 90° rosca hembra
Joelho rosca fêmea 90°

Article number	Bag / Box	Type
6PKW-1603-N	10 pc. / 60 pc.	16x3/8"
6PKW-1604-N	10 pc. / 60 pc.	16x1/2"
6PKW-2004-N	10 pc. / 60 pc.	20x1/2"
6PKW-2005-N	10 pc. / 50 pc.	20x3/4"
6PKW-2605-N	10 pc. / 50 pc.	26x3/4"
6PKW-3206-N	5 pc. / 20 pc.	32x1"

Type: 9PKW



T-piece
Te
Tê

Article number	Bag / Box	Type
9PKW-161616	10 pc. / 60 pc.	16x16x16
9PKW-202020	10 pc. / 50 pc.	20x20x20
9PKW-262626	5 pc. / 30 pc.	26x26x26
9PKW-323232	5 pc. / 15 pc.	32x32x32

Type: 10PKW



T-reduced centre
Te con centro reducido
Tê de redução ao centro

Article number	Bag / Box	Type
10PKW-201620	10 pc. / 50 pc.	20x16x20
10PKW-261626	5 pc. / 30 pc.	26x16x26
10PKW-262026	5 pc. / 30 pc.	26x20x26
10PKW-321632	5 pc. / 25 pc.	32x16x32
10PKW-322032	5 pc. / 25 pc.	32x20x32
10PKW-322632	5 pc. / 20 pc.	32x26x32

Type: 11PKW



T-branch and line reduced
Te reducida
Tê de redução

Article number	Bag / Box	Type
11PKW-201616	10 pc. / 50 pc.	20x16x16
11PKW-202016	10 pc. / 50 pc.	20x20x16
11PKW-261616	10 pc. / 50 pc.	26x16x16
11PKW-261620	5 pc. / 30 pc.	26x16x20
11PKW-262016	5 pc. / 30 pc.	26x20x16
11PKW-262020	5 pc. / 30 pc.	26x20x20
11PKW-262616	5 pc. / 30 pc.	26x26x16
11PKW-262620	5 pc. / 30 pc.	26x26x20
11PKW-322026	5 pc. / 20 pc.	32x20x26
11PKW-322626	5 pc. / 20 pc.	32x26x26



Type: 12PKW



T-enlarged branch
Te, ampliación centro
Tê extensão centro

Article number	Bag / Box	Type
12PKW-162016	10 pc. / 50 pc.	16x20x16
12PKW-202620	5 pc. / 30 pc.	20x26x20
12PKW-263226	5 pc. / 20 pc.	26x32x26

Type: 13PKW (CW617)



PK-TOOL p 157

T-female centre
Te, rosca hembra centro
Tê fêmea rosca centro

Article number	Bag / Box	Type
13PKW-160416	10 pc. / 50 pc.	16x1/2"x16
13PKW-200420	10 pc. / 50 pc.	20x1/2"x20
13PKW-200520	10 pc. / 30 pc.	20x3/4"x20
13PKW-260426	5 pc. / 30 pc.	26x1/2"x26
13PKW-260526	5 pc. / 30 pc.	26x3/4"x26
13PKW-320532	5 pc. / 15 pc.	32x3/4"x32
13PKW-320632	5 pc. / 10 pc.	32x1"x32

Type: 13PKW-X (INOX)



T-female centre
Te, rosca hembra centro
Tê fêmea rosca centro

Article number	Bag / Box	Type
13PKW-160416-X	10 pc. / 50 pc.	16x1/2"x16
13PKW-200420-X	10 pc. / 50 pc.	20x1/2"x20
13PKW-200520-X	10 pc. / 30 pc.	20x3/4"x20
13PKW-260426-X	5 pc. / 30 pc.	26x1/2"x26
13PKW-260526-X	5 pc. / 30 pc.	26x3/4"x26
13PKW-260526-X	5 pc. / 30 pc.	26x3/4"x26
13PKW-320532-X	5 pc. / 15 pc.	32x3/4"x32
13PKW-320632-X	5 pc. / 10 pc.	32x1"x32

Type: 13PKW-N (CW602)



PK-TOOL p 157

T-female centre
Te, rosca hembra centro
Tê fêmea rosca centro

Article number	Bag / Box	Type
13PKW-160416-N	10 pc. / 50 pc.	16x1/2"x16
13PKW-200420-N	10 pc. / 50 pc.	20x1/2"x20
13PKW-200520-N	10 pc. / 30 pc.	20x3/4"x20
13PKW-260426-N	5 pc. / 30 pc.	26x1/2"x26
13PKW-260526-N	5 pc. / 30 pc.	26x3/4"x26
13PKW-320532-N	5 pc. / 15 pc.	32x3/4"x32
13PKW-320632-N	5 pc. / 10 pc.	32x1"x32

- 1
- 2
- 3
- 4
- 5
- 6
- 7
- 8
- 9
- 10
- 11
- 12



B. PKW

Type: 14PKW (CW617)



PK-TOOL p 157

T-male centre

Te, rosca macho centro

Tê, macho centro

Article number	Bag / Box	Type
14PKW-160416	10 pc. / 50 pc.	16x1/2"x16
14PKW-200420	10 pc. / 40 pc.	20x1/2"x20
14PKW-200520	10 pc. / 30 pc.	20x3/4"x20
14PKW-320532	5 pc. / 15 pc.	32x3/4"x32

Type: 14PKW-N (CW602)



PK-TOOL p 157

T-male centre

Te, rosca macho centro

Tê, macho centro

Article number	Bag / Box	Type
14PKW-160416-N	10 pc. / 50 pc.	16x1/2"x16
14PKW-200420-N	10 pc. / 40 pc.	20x1/2"x20
14PKW-200520-N	10 pc. / 30 pc.	20x3/4"x20

Type: 15PKW



Coupling

Manguito

União

Article number	Bag / Box	Type
15PKW-1616	10 pc. / 150 pc.	16x16
15PKW-2020	10 pc. / 80 pc.	20x20
15PKW-2626	5 pc. / 50 pc.	26x26
15PKW-3232	5 pc. / 30 pc.	32x32

Type: 16PKW



Reducing coupling

Manguito reducción

Redução

Article number	Bag / Box	Type
16PKW-2016	10 pc. / 100 pc.	20x16
16PKW-2616	5 pc. / 60 pc.	26x16
16PKW-2620	5 pc. / 50 pc.	26x20
16PKW-3216	5 pc. / 50 pc.	32x16
16PKW-3220	5 pc. / 40 pc.	32x20
16PKW-3226	5 pc. / 40 pc.	32x26



Type: 17PKW (CW617)



PK-TOOL p 157

Straight male adapter
Racor recto macho
União de transição macho

Article number	Bag / Box	Type
17PKW-1604	10 pc. / 80 pc.	16x1/2"
17PKW-2004	10 pc. / 80 pc.	20x1/2"
17PKW-2005	10 pc. / 50 pc.	20x3/4"
17PKW-2605	10 pc. / 50 pc.	26x3/4"
17PKW-2606	10 pc. / 40 pc.	26x1"
17PKW-3206	10 pc. / 40 pc.	32x1"
17PKW-3207	5 pc. / 25 pc.	32 x 1 1/4"

Type: 17PKW-N (CW602)



PK-TOOL p 157

Straight male adapter
Racor recto macho
União de transição macho

Article number	Bag / Box	Type
17PKW-1604-N	10 pc. / 80 pc.	16x1/2"
17PKW-2004-N	10 pc. / 80 pc.	20x1/2"
17PKW-2005-N	10 pc. / 50 pc.	20x3/4"
17PKW-2605-N	10 pc. / 50 pc.	26x3/4"
17PKW-2606-N	10 pc. / 40 pc.	26x1"
17PKW-3206-N	10 pc. / 40 pc.	32x1"
17PKW-3207-N	5 pc. / 25 pc.	32 x 1 1/4"

Type: 18PKW (CW617)



PK-TOOL p 157

Straight female adapter
Racor recto hembra
União de transição fêmea

Article number	Bag / Box	Type
18PKW-1604	10 pc. / 80 pc.	16x1/2"
18PKW-2004	10 pc. / 80 pc.	20x1/2"
18PKW-2005	10 pc. / 50 pc.	20x3/4"
18PKW-2605	10 pc. / 50 pc.	26x3/4"
18PKW-2606	10 pc. / 40 pc.	26x1"
18PKW-3206	10 pc. / 40 pc.	32x1"
18PKW-3207	5 pc. / 25 pc.	32x1 1/4"

Type: 18PKW-X (INOX)



Straight female adapter
Racor recto hembra
União de transição fêmea

Article number	Bag / Box	Type
18PKW-1604-X	10 pc. / 80 pc.	16x1/2"
18PKW-2004-X	10 pc. / 80 pc.	20x1/2"
18PKW-2005-X	10 pc. / 50 pc.	20x3/4"
18PKW-2605-X	10 pc. / 50 pc.	26x3/4"
18PKW-2606-X	10 pc. / 40 pc.	26x1"
18PKW-3206-X	10 pc. / 40 pc.	32x1"
18PKW-3207-X	5 pc. / 25 pc.	32x1 1/4"



B. PKW

1

Type: 18PKW-N (CW602)

2

3

4

5

6

7



PK-TOOL p 157

Straight female adapter
Racor recto hembra
União de transição fêmea

Article number	Bag / Box	Type
18PKW-1604-N	10 pc. / 80 pc.	16x1/2"
18PKW-2004-N	10 pc. / 80 pc.	20x1/2"
18PKW-2005-N	10 pc. / 50 pc.	20x3/4"
18PKW-2605-N	10 pc. / 50 pc.	26x3/4"
18PKW-2606-N	10 pc. / 40 pc.	26x1"
18PKW-3206-N	10 pc. / 40 pc.	32x1"
18PKW-3207-N	5 pc. / 25 pc.	32x1 1/4"

8

Type: 19PKW

9

10

11

12



Press fitting to eurocone
Racor eurocono roscado recto
Encaixe pushfit com Eurocone

Article number	Bag / Box	Type
19PKW-1605	10 pc. / 80 pc.	16x3/4"
19PKW-2005	10 pc. / 80 pc.	20x3/4"

Type: 26PKW



Press fitting with flat sealing
Racor a presión con junta giratoria y plana
Junta de compressão giratória com junta plana

Article number	Bag / Box	Type
26PKW-1605	10 pc. / 80 pc.	16x3/4"
26PKW-2005	10 pc. / 80 pc.	20x3/4"

Type: 27PKW



45° bend
Codo 45°
Joelho de 45°

Article number	Bag / Box	Type
27PKW-2626	5 pc. / 50 pc.	26x26
27PKW-3232	5 pc. / 30 pc.	32x32



Gas: only allowed in countries where has been a HENCO GAS testing + certificate is available! (See www.henco.be)
Gas: solo permitido en países donde se ha realizado una prueba + certificado de HENCO GAS disponible. (ver www.henco.be)
Gás: permitido apenas em países onde o Henco Gás + o certificado está disponível! (Veja www.henco.be)

Henco press fittings synthetic for gas in combination with standard pipe gas, see page 17



Type: 1PKG



Elbow 90°
Codo 90°
Joelho de 90°

Article number	Bag / Box	Type
1PKG-1616	10 pc. / 120 pc.	16x16
1PKG-2020	10 pc. / 80 pc.	20x20
1PKG-2626	5 pc. / 50 pc.	26x26
1PKG-3232	5 pc. / 30 pc.	32x32
1PKG-4040	5 pc. / 20 pc.	40x40

Type: 2PKG



Backplate elbow female
Codo con soporte, rosca hembra
Joelho com suporte, rosca fêmea

Article number	Bag / Box	Type
2PKG-1603	10 pc. / 50 pc.	16x3/8" (56 mm)
2PKG-1604BP *	10 pc. / 50 pc.	16x1/2" (56 mm)
2PKG-2004BP *	10 pc. / 50 pc.	20x1/2" (56 mm)
2PKG-2005	5 pc. / 30 pc.	20x3/4" (56 mm)
2PKG-2605	5 pc. / 30 pc.	26x3/4" (56 mm)

* With black plug BP04 1/2"

Type: 2PKG-K



Backplate elbow female, short model
Codo con soporte, rosca hembra, corto
Joelho com suporte, rosca fêmea, curto

Article number	Bag / Box	Type
2PKG-1604KBP *	10 pc. / 50 pc.	16x1/2" (40 mm)

* With black plug BP04 1/2"



C. PKG

Type: 5PKG



PK-TOOL p 157

Bend 90° male adapter

Codo 90° rosca macho

Joelho macho de 90

Article number	Bag / Box	Type
5PKG-1604	10 pc. / 60 pc.	16x1/2"
5PKG-2004	10 pc. / 60 pc.	20x1/2"
5PKG-2005	10 pc. / 50 pc.	20x3/4"
5PKG-2605	10 pc. / 40 pc.	26x3/4"
5PKG-3206	5 pc. / 20 pc.	32x1"
5PKG-4007	5 pc. / 15 pc.	40x1 1/4"

Type: 6PKG



PK-TOOL p 157

Bend 90° female adapter

Codo 90° rosca hembra

Joelho rosca fêmea 90°

Article number	Bag / Box	Type
6PKG-1604BP *	10 pc. / 60 pc.	16x1/2"
6PKG-2004BP *	10 pc. / 60 pc.	20x1/2"
6PKG-2005	10 pc. / 50 pc.	20x3/4"
6PKG-2605	10 pc. / 50 pc.	26x3/4"
6PKG-3206	5 pc. / 20 pc.	32x1"
6PKG-4007	5 pc. / 15 pc.	40x1 1/4"

* With black plug BP04 1/2"

Type: 9PKG



T-piece

Te

Tê

Article number	Bag / Box	Type
9PKG-161616	10 pc. / 60 pc.	16x16x16
9PKG-202020	10 pc. / 50 pc.	20x20x20
9PKG-262626	5 pc. / 30 pc.	26x26x26
9PKG-323232	5 pc. / 15 pc.	32x32x32
9PKG-404040	5 pc. / 10 pc.	40x40x40



Type: 10PKG



T-reduced centre

Te reducida

Tê de redução

Article number	Bag / Box	Type
10PKG-201620	10 pc. / 50 pc.	20x16x20
10PKG-261626	5 pc. / 30 pc.	26x16x26
10PKG-262026	5 pc. / 30 pc.	26x20x26
10PKG-321632	5 pc. / 25 pc.	32x16x32
10PKG-322032	5 pc. / 25 pc.	32x20x32
10PKG-322632	5 pc. / 20 pc.	32x26x32
10PKG-401640	5 pc. / 15 pc.	40x16x40
10PKG-402040	5 pc. / 15 pc.	40x20x40
10PKG-402640	5 pc. / 15 pc.	40x26x40
10PKG-403240	5 pc. / 10 pc.	40x32x40

Type: 11PKG



T-branch and line reduced

Te reducida

Tê 2x redução

Article number	Bag / Box	Type
11PKG-201616	10 pc. / 50 pc.	20x16x16
11PKG-202016	10 pc. / 50 pc.	20x20x16
11PKG-261620	5 pc. / 30 pc.	26x16x20
11PKG-262016	5 pc. / 30 pc.	26x20x16
11PKG-262020	5 pc. / 30 pc.	26x20x20
11PKG-262616	5 pc. / 30 pc.	26x26x16
11PKG-262620	5 pc. / 30 pc.	26x26x20
11PKG-322026	5 pc. / 20 pc.	32x20x26
11PKG-322626	5 pc. / 20 pc.	32x26x26
11PKG-402032	5 pc. / 15 pc.	40x20x32
11PKG-402632	5 pc. / 15 pc.	40x26x32
11PKG-403232	5 pc. / 10 pc.	40x32x32
11PKG-404026	5 pc. / 10 pc.	40x40x26
11PKG-404032	5 pc. / 10 pc.	40x40x32

Type: 12PKG



T-enlarged branch

Te, ampliación centro

Tê extensão central

Article number	Bag / Box	Type
12PKG-162016	10 pc. / 50 pc.	16x20x16
12PKG-202620	5 pc. / 30 pc.	20x26x20
12PKG-263226	5 pc. / 20 pc.	26x32x26
12PKG-324032	5 pc. / 15 pc.	32x40x32

- 1
- 2
- 3
- 4
- 5
- 6
- 7
- 8
- 9
- 10
- 11
- 12



C. PKG

1 Type: 13PKG

2



PK-TOOL p 157

3

4

5

6

7

8

9

10

11

12

T-female branch

Te rosca hembra centro

Tê fêmea rosca centro

Article number	Bag / Box	Type
13PKG-160416BP *	10 pc. / 50 pc.	16x1/2"x16
13PKG-200420BP *	10 pc. / 50 pc.	20x1/2"x20
13PKG-200520	10 pc. / 30 pc.	20x3/4"x20
13PKG-260420BP *	5 pc. / 30 pc.	26x1/2"x20
13PKG-260426BP *	5 pc. / 30 pc.	26x1/2"x26
13PKG-260526	5 pc. / 30 pc.	26x3/4"x26
13PKG-320532	5 pc. / 15 pc.	32x3/4"x32
13PKG-320632	5 pc. / 10 pc.	32x1"x32
13PKG-320732	5 pc. / 10 pc.	32x1 1/4"x32
13PKG-400640	5 pc. / 10 pc.	40x1"x40
13PKG-400740	5 pc. / 10 pc.	40x1 1/4"x40

* With black plug BP04 1/2"

Type: 14PKG



PK-TOOL p 157

T-male branch

Te rosca macho centro

Tê, macho centro

Article number	Bag / Box	Type
14PKG-160416	10 pc. / 50 pc.	16x1/2"x16
14PKG-200420	10 pc. / 40 pc.	20x1/2"x20
14PKG-260426	5 pc. / 30 pc.	26x1/2"x26
14PKG-260626	5 pc. / 20 pc.	26x1"x26

Type: 15PKG



Straight coupling

Manguito

União

Article number	Bag / Box	Type
15PKG-1616	10 pc. / 150 pc.	16x16
15PKG-2020	10 pc. / 80 pc.	20x20
15PKG-2626	5 pc. / 50 pc.	26x26
15PKG-3232	5 pc. / 30 pc.	32x32
15PKG-4040	5 pc. / 25 pc.	40x40



Type: 16PKG



**Reducing coupling
Manguito reducción
União redução**

Article number	Bag / Box	Type
16PKG-2016	10 pc. / 100 pc.	20x16
16PKG-2616	5 pc. / 60 pc.	26x16
16PKG-2620	5 pc. / 50 pc.	26x20
16PKG-3216	5 pc. / 50 pc.	32x16
16PKG-3220	5 pc. / 40 pc.	32x20
16PKG-3226	5 pc. / 40 pc.	32x26
16PKG-4026	5 pc. / 30 pc.	40x26
16PKG-4032	5 pc. / 25 pc.	40x32

Type: 17PKG



PK-TOOL p 157

**Straight male adapter
Racor recto macho
Encaixe macho**

Article number	Bag / Box	Type
17PKG-1604	10 pc. / 80 pc.	16x1/2"
17PKG-2004	10 pc. / 80 pc.	20x1/2"
17PKG-2005	10 pc. / 50 pc.	20x3/4"
17PKG-2605	10 pc. / 50 pc.	26x3/4"
17PKG-2606	10 pc. / 40 pc.	26x1"
17PKG-3206	10 pc. / 40 pc.	32x1"
17PKG-3207	5 pc. / 25 pc.	32x1 1/4"
17PKG-4006	5 pc. / 25 pc.	40x1"
17PKG-4007	5 pc. / 25 pc.	40x1 1/4"

Type: 18PKG



PK-TOOL p 157

**Straight female adapter
Racor recto hembra
Encaixe fêmea**

Article number	Bag / Box	Type
18PKG-1604	10 pc. / 80 pc.	16x1/2"
18PKG-2004	10 pc. / 80 pc.	20x1/2"
18PKG-2005	10 pc. / 50 pc.	20x3/4"
18PKG-2605	10 pc. / 50 pc.	26x3/4"
18PKG-2606	10 pc. / 40 pc.	26x1"
18PKG-3206	10 pc. / 40 pc.	32x1"
18PKG-3207	5 pc. / 25 pc.	32x1 1/4"
18PKG-4006	5 pc. / 25 pc.	40x1"
18PKG-4007	5 pc. / 25 pc.	40x1 1/4"

Type: 27PKG



**45° bend
Codo 45°
Joelho de 45°**

Article number	Bag / Box	Type
27PKG-4040	5 pc. / 25 pc.	40x40

- 1
- 2
- 3
- 4
- 5
- 6
- 7
- 8
- 9
- 10
- 11
- 12



D. PKS

Henco press fittings synthetic for Sprinkler in combination with standard pipe sprinkler, see page 18



Sprinkler: only allowed in countries where a HENCO Sprinkler certificate is available! (see www.henco.be)
 Sprinkler: solo se permite en países donde hay disponible un certificado de sprinkler HENCO. (ver www.henco.be)
 Sprinkler: permitido apenas em países onde o certificado HENCO Sprinkler está disponível! (veja www.henco.be)

1

2

Type: 1PKS



Elbow 90°

Codo 90°

90° Joelho

Article number	Bag / Box	Type
1PKS-3232	5 pc. / 30 pc.	32 x 32
1PKS-4040	5 pc. / 20 pc.	40 x 40
1PKS-5050	1 pc. / 8 pc.	50x 50
1PKS-6363	1 pc. / 6 pc.	63 x 63

3

4

5

6

7

8

Type: 5PKS (CW617)



Elbow 90° male adapter

Codo 90° rosca macho

Joelho macho de 90°

Article number	Bag / Box	Type
5PKS-3206	5 pc. / 20 pc.	32 x 1"
5PKS-4007	3 pc. / 15 pc.	40 x 1,1/4"
5PKS-5007	1 pc. / 10 pc.	50x 1,1/4"
5PKS-5008	1 pc. / 8 pc.	50x 1,1/2"
5PKS-6310	1 pc. / 4 pc.	63 x 2"

9

10

11

12

Type: 5PKS-N (CW602)



Elbow 90° male adapter

Codo 90° rosca macho

Joelho macho de 90°

Article number	Bag / Box	Type
5PKS-3206-N	5 pc. / 20 pc.	32 x 1"
5PKS-4007-N	5 pc. / 15 pc.	40 x 1,1/4"
5PKS-5007-N	1 pc. / 8 pc.	50x 1,1/4"
5PKS-5008-N	1 pc. / 8 pc.	50x 1,1/2"
5PKS-6310-N	1 pc. / 4 pc.	63 x 2"

Type: 6PKS (CW617)



Elbow 90° female adapter

Codo 90° rosca hembra

Joelho rosca fêmea 90°

Article number	Bag / Box	Type
6PKS-3204	5 pc. / 20 pc.	32 x 1/2"
6PKS-3206	5 pc. / 20 pc.	32 x 1"
6PKS-4004	3 pc. / 15 pc.	40 x 1/2"
6PKS-4007	5 pc. / 15 pc.	40 x 1,1/4"
6PKS-5004	1 pc. / 8 pc.	50x 1/2"
6PKS-5007	1 pc. / 8 pc.	50x 1,1/4"
6PKS-5008	1 pc. / 8 pc.	50x 1,1/2"
6PKS-6304	1 pc. / 4 pc.	63 x 1/2"
6PKS-6310	1 pc. / 4 pc.	63 x 2"



Type: 6PKS-N (CW602)



Elbow 90° female adapter
Codo 90° rosca hembra
Joelho rosca fêmea 90°

Article number	Bag / Box	Type
6PKS-3204-N	5 pc. / 20 pc.	32 x 1/2"
6PKS-3206-N	5 pc. / 20 pc.	32 x 1"
6PKS-4004-N	3 pc. / 15 pc.	40 x 1/2"
6PKS-4007-N	5 pc. / 15 pc.	40 x 1,1/4"
6PKS-5004-N	1 pc. / 8 pc.	50x 1/2"
6PKS-5007-N	1 pc. / 8 pc.	50x 1,1/4"
6PKS-5008-N	1 pc. / 8 pc.	50x 1,1/2"
6PKS-6304-N	1 pc. / 4 pc.	63 x 1/2"
6PKS-6310-N	1 pc. / 4 pc.	63 x 2"

Type: 9PKS



T-piece
Te
Tê

Article number	Bag / Box	Type
9PKS-323232	5 pc. / 15 pc.	32 x 32 x 32
9PKS-404040	5 pc. / 10 pc.	40 x 40 x 40
9PKS-505050	1 pc. / 6 pc.	50 x 50 x 50
9PKS-636363	1 pc. / 3 pc.	63 x 63 x 63

Type: 10PKS



T-reduced centre
Té reducida
Tê de redução

Article number	Bag / Box	Type
10PKS-402640	5 pc. / 15 pc.	40 x 26 x 40
10PKS-403240	5 pc. / 10 pc.	40 x 32 x 40
10PKS-503250	1 pc. / 8 pc.	50 x 32 x 50
10PKS-504050	1 pc. / 6 pc.	50 x 40 x 50
10PKS-633263	1 pc. / 3 pc.	63 x 32 x 63
10PKS-634063	1 pc. / 3 pc.	63 x 40 x 63
10PKS-635063	1 pc. / 3 pc.	63 x 50 x 63

Type: 11PKS



T-branche and line reduced
Te reducida
Tê 2x redução

Article number	Bag / Box	Type
11PKS-403232	5 pc. / 10 pc.	40 x 32 x 32
11PKS-404032	5 pc. / 10 pc.	40 x 40 x 32
11PKS-503240	1 pc. / 10 pc.	50 x 32 x 40
11PKS-504040	1 pc. / 8 pc.	50 x 40 x 40

- 1
- 2
- 3
- 4
- 5
- 6
- 7
- 8
- 9
- 10
- 11
- 12



D. PKS

1 Type: 12PKS

2

3

4

5

6



T-enlarged branch
Te, ampliación centro
Tê extensão central

Article number	Bag / Box	Type
12PKS-324032	5 pc. / 15 pc.	32 x 40 x 32
12PKS-405040	1 pc. / 8 pc.	40 x 50 x 40

7 Type: 13PKS (CW617)

8

9

10

11

12



T-female branch
Te rosca hembra centro
Tê fêmea rosca centro

Article number	Bag / Box	Type
13PKS-260426	5 pc. / 30 pc.	26 x 1/2" x 26
13PKS-320432	5 pc. / 20 pc.	32 x 1/2" x 32
13PKS-320532	5 pc. / 15 pc.	32 x 3/4" x 32
13PKS-320632	5 pc. / 10 pc.	32 x 1" x 32
13PKS-320732	5 pc. / 10 pc.	32 x 1,1/4" x 32
13PKS-400440	5 pc. / 10 pc.	40 x 1/2" x 40
13PKS-400640	5 pc. / 10 pc.	40 x 1" x 40
13PKS-400740	5 pc. / 10 pc.	40 x 1,1/4" x 40
13PKS-500450	1 pc. / 4 pc.	50 x 1/2" x 50
13PKS-500550	1 pc. / 4 pc.	50 x 3/4" x 50
13PKS-500850	1 pc. / 4 pc.	50 x 1,1/2" x 50
13PKS-630463	1 pc. / 2 pc.	63 x 1/2" x 63
13PKS-631063	1 pc. / 2 pc.	63 x 2" x 63

Type: 13PKS-N (CW602)



T-female branch
Te rosca hembra centro
Tê fêmea rosca centro

Article number	Bag / Box	Type
13PKS-260426-N	5 pc. / 30 pc.	26 x 1/2" x 26
13PKS-320432-N	5 pc. / 20 pc.	32 x 1/2" x 32
13PKS-320532-N	5 pc. / 15 pc.	32 x 3/4" x 32
13PKS-320632-N	5 pc. / 10 pc.	32 x 1" x 32
13PKS-320732-N	5 pc. / 10 pc.	32 x 1,1/4" x 32
13PKS-400440-N	5 pc. / 10 pc.	40 x 1/2" x 40
13PKS-400640-N	5 pc. / 10 pc.	40 x 1" x 40
13PKS-400740-N	5 pc. / 10 pc.	40 x 1,1/4" x 40
13PKS-500450-N	1 pc. / 4 pc.	50 x 1/2" x 50
13PKS-500550-N	1 pc. / 4 pc.	50 x 3/4" x 50
13PKS-500850-N	1 pc. / 4 pc.	50 x 1,1/2" x 50
13PKS-630463-N	1 pc. / 2 pc.	63 x 1/2" x 63
13PKS-631063-N	1 pc. / 2 pc.	63 x 2" x 63



Type: 14PKS (CW617)



T-male branch
Te rosca macho centro
Tê, macho centro

Article number	Bag / Box	Type
14PKS-320532	5 pc. / 15 pc.	32 x 3/4" x 32
14PKS-400640	5 pc. / 10 pc.	40 x 1" x 40
14PKS-400740	5 pc. / 10 pc.	40 x 1,1/4" x 40
14PKS-500850	1 pc. / 5 pc.	50 x 1,1/2" x 50
14PKS-631063	1 pc. / 2 pc.	63 x 2" x 63

Type: 14PKS-N (CW602)



T-male branch
Te rosca macho centro
Tê, macho centro

Article number	Bag / Box	Type
14PKS-320532-N	5 pc. / 15 pc.	32 x 3/4" x 32
14PKS-400640-N	5 pc. / 10 pc.	40 x 1" x 40
14PKS-400740-N	5 pc. / 10 pc.	40 x 1,1/4" x 40
14PKS-500850-N	1 pc. / 5 pc.	50 x 1,1/2" x 50
14PKS-631063-N	1 pc. / 2 pc.	63 x 2" x 63

Type: 15PKS



Coupling
Manguito
União

Article number	Bag / Box	Type
15PKS-3232	5 pc. / 30 pc.	32 x 32
15PKS-4040	5 pc. / 25 pc.	40 x 40
15PKS-5050	1 pc. / 12 pc.	50 x 50
15PKS-6363	1 pc. / 9 pc.	63 x 63

Type: 16PKS



Reducing coupling
Manguito reducción
União redução

Article number	Bag / Box	Type
16PKS-4032	5 pc. / 25 pc.	40 x 32
16PKS-5032	1 pc. / 15 pc.	50 x 32
16PKS-5040	1 pc. / 15 pc.	50 x 40
16PKS-6340	1 pc. / 8 pc.	63 x 40
16PKS-6350	1 pc. / 8 pc.	63 x 50

- 1
- 2
- 3
- 4
- 5
- 6
- 7
- 8
- 9
- 10
- 11
- 12



D. PKS

Type: 17PKS (CW617)



Straight male adapter
Racor recto macho
Encaixe macho

Article number	Bag / Box	Type
17PKS-3206	10 pc. / 40 pc.	32 x 1"
17PKS-3207	5 pc. / 25 pc.	32 x 1,1/4"
17PKS-4006	5 pc. / 25 pc.	40 x 1"
17PKS-4007	5 pc. / 25 pc.	40 x 1,1/4"
17PKS-5008	1 pc. / 10 pc.	50 x 1,1/2"
17PKS-6310	1 pc. / 6 pc.	63 x 2"

Type: 17PKS-N (CW602)



Straight male adapter
Racor recto macho
Encaixe macho

Article number	Bag / Box	Type
17PKS-3206-N	10 pc. / 40 pc.	32 x 1"
17PKS-3207-N	5 pc. / 25 pc.	32 x 1,1/4"
17PKS-4006-N	5 pc. / 25 pc.	40 x 1"
17PKS-4007-N	5 pc. / 25 pc.	40 x 1,1/4"
17PKS-5008-N	1 pc. / 10 pc.	50 x 1,1/2"
17PKS-6310-N	1 pc. / 6 pc.	63 x 2"

Type: 18PKS (CW617)



Straight female adapter
Racor recto hembra
Encaixe fêmea 14x1/2" fêmea

Article number	Bag / Box	Type
18PKS-3204	10 pc. / 40 pc.	32 x 1/2"
18PKS-3206	10 pc. / 40 pc.	32 x 1"
18PKS-3207	5 pc. / 25 pc.	32 x 1,1/4"
18PKS-4006	5 pc. / 25 pc.	40 x 1"
18PKS-4007	5 pc. / 25 pc.	40 x 1,1/4"
18PKS-5008	1 pc. / 10 pc.	50 x 1,1/2"
18PKS-6310	1 pc. / 6 pc.	63 x 2"

Type: 18PKS-N (CW602)



Straight coupling
Racor recto hembra
Encaixe fêmea 14x1/2" fêmea

Article number	Bag / Box	Type
18PKS-3204-N	10 pc. / 40 pc.	32 x 1/2"
18PKS-3206-N	10 pc. / 40 pc.	32 x 1"
18PKS-3207-N	5 pc. / 25 pc.	32 x 1,1/4"
18PKS-4006-N	5 pc. / 25 pc.	40 x 1"
18PKS-4007-N	5 pc. / 25 pc.	40 x 1,1/4"
18PKS-5008-N	1 pc. / 10 pc.	50 x 1,1/2"
18PKS-6310-N	1 pc. / 6 pc.	63 x 2"



Type: 27PKS



45° bend
Codo 45°
Joelho de 45°

Article number	Bag / Box	Type
27PKS-3232	5 pc. / 30 pc.	32 x 32
27PKS-4040	2 pc. / 25 pc.	40 x 40
27PKS-5050	1 pc. / 10 pc.	50 x 50
27PKS-6363	1 pc. / 5 pc.	63 x 63

Type: 50P



Stainless steel sprinkler connection with stainless steel cup
Conexión en Inox para SPRINKLER Henco
Ligação em aço inoxidável para SPRINKLER Henco

Article number	Bag / Box	Type
50P-3206	1 pc. / 15 pc.	32 x 1" (23 mm)
50P-320604	1 pc. / 15 pc.	32 x 1/2" (23 mm)
50P-320605	1 pc. / 15 pc.	32 x 3/4" (23 mm)
50P43-320604	1 pc. / 15 pc.	32 x 1/2" (43 mm)

Type: 52PS



Easy mounting/repair
Accesorio manguito de reparación
Acessório de reparação de fácil montagem

Article number	Bag / Box	Type
52PS32	1 pc. / 20 pc.	32x32

Type: 53PS



Easy mounting/repair
Accesorio manguito de reparación
Acessório de reparação de fácil montagem

Article number	Bag / Box	Type
53PKS40	1 pc. / 20 pc.	40x40
53PKS50	1 pc. / 9 pc.	50x50
53PKS63	1 pc. / 6 pc.	63x63

- 1
- 2
- 3
- 4
- 5
- 6
- 7
- 8
- 9
- 10
- 11
- 12



E. SUPER SIZES - Systematic solution for big sizes

A = 75mm | B = 90mm

1 Detailed overview of Super Sizes possibilities

2

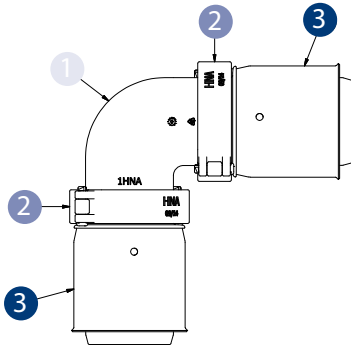

1PK

- 1 1HNA or 1HNB
- 2 HNA or HNB
- 3 8HNA-PK40 or 8HNA-PK50 or 8HNA-PK63 or 8HNA-PK75 or 8HNB-PK90

Example / Voorbeeld / Exemple / Exemplo

1PK-7575 = 1x 1HNA + 2xHNA + 2x 8HNA-PK75

3

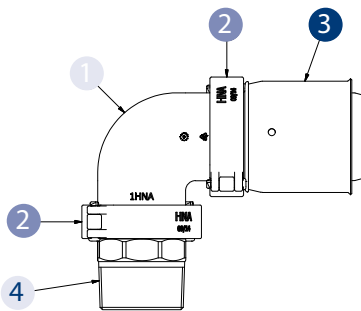

5PK / 6PK

- 1 1HNA or 1HNB
- 2 HNA or HNB
- 3 8HNA-PK75 or 8HNB-PK90
- 4 17HNA-10 or 17HNA-12 or 18HNA-06 or 18HNA-10 or 18HNA-12 or 18HNB-14

Example / Voorbeeld / Exemple / Exemplo

5PK-7510 = 1x 1HNA + 2xHNA + 1x 8HNA-PK75 + 1x17HNA-10

4

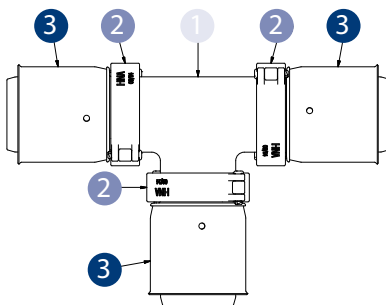

9PK / 10PK / 11PK / 12PK (75mm)

- 1 9HNA
- 2 HNA
- 3 8HNA-PK32 or 8HNA-PK40 or 8HNA-PK50 or 8HNA-PK63 or 8HNA-PK75

Example / Voorbeeld / Exemple / Exemplo

9PK-757575 = 1x 9HNA + 3xHNA + 3x 8HNA-PK75

5

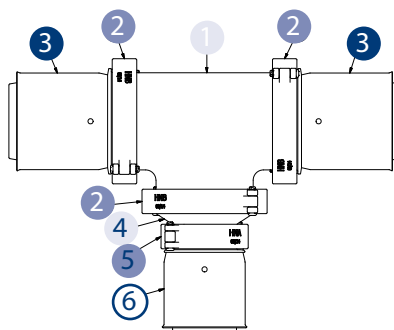

10PK / 11PK / 12PK (90mm)

- 1 9HNB
- 2 HNB
- 3 8HNB-PK90
- 4 16HNB
- 5 HNA
- 6 8HNA-PK32 or 8HNA-PK40 or 8HNA-PK50 or 8HNA-PK63 or 8HNA-PK75

Example / Voorbeeld / Exemple / Exemplo

10PK-905090 = 1x 9HNB + 3x HNB + 2x 8HNB-PK90 + 1x 16HNB + 1xHNA + 8HNA-PK50

E. SUPER SIZES - Systematic solution for big sizes

A = 75mm | B = 90 mm

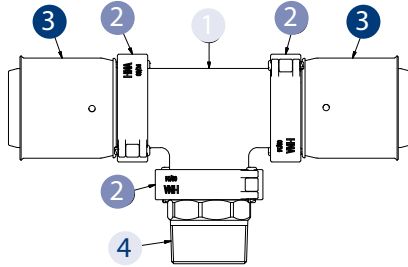

13PK / 14PK

- 1 9HNA or 9HNB
- 2 HNA or HNB
- 3 8HNA-PK75 or 8HNB-PK90
- 4 17HNA-10 or 17HNA-12 or 18HNA-06 or 18HNA-10 or 18HNA-12 or 18HNB-14

Example / Voorbeeld / Exemple / Exemplo

13PK-750675 = 1x 9HNA + 3x HNA + 8HNA-PK75 + 18HNA-06

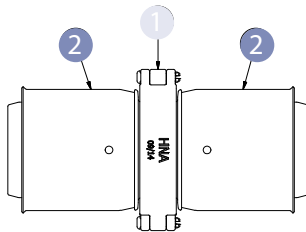

15PK / 16PK

- 1 HNA or HNB
- 2 8HNA-PK75 or 8HNB-PK90

Example / Voorbeeld / Exemple / Exemplo

15PK-7575 = 1x HNA + 2x 8HNA-PK75

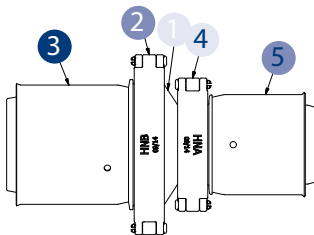

16PK

- 1 16HNBA
- 2 HNB
- 3 8HNB-PK90
- 4 HNA
- 5 8HNA-PK32 or 8HNA-PK40 or 8HNA-PK50 or 8HNA-PK63 or 8HNA-PK75

Example / Voorbeeld / Exemple / Exemplo

16PK-9063 = 1x 16HNBA + 1x HNB + 1x 8HNB-PK90 + 1x HNA + 1x 8HNA-PK63

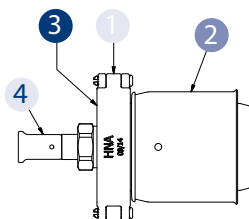

16PK-7516

- 1 HNA
- 2 8HNA-PK75
- 3 HNA-05
- 4 19P-1605 or 19P-1805 or 19P-2005 or 33P-1605 or 19SK-1605 or 19SK-2005

1

2

3

4

5

6

7

8

9

10

11

12



E. SUPER SIZES - Systematic solution for big sizes

A = 75mm | B = 90 mm

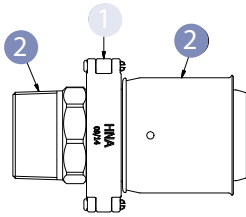

17PK / 18PK

- ① HNA or HNB
- ② 8HNA-PK75 or 8HNB-PK90

Example / Voorbeeld / Exemple / Exemplo

18PK-7512 = 1x HNA + 1x 8HNA-PK75 + 1x 18HNA-12

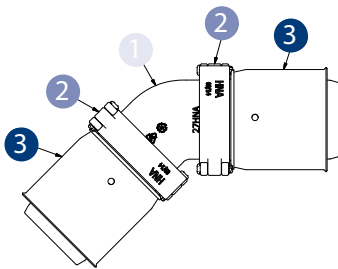

27PK

- ① 27HNA or 27HNB
- ② HNA or HNB
- ③ 8HNA-PK75 or 8HNB-PK90

Example / Voorbeeld / Exemple / Exemplo

27PK-9090 = 1x 27HNB + 2xHNB + 2x 8HNB-PK90

SUPER SIZE MONTAGE

*HN connection = "click and lock"
*PK connection = press connection

Possibilities

HNA: PK32 / PK40 / PK50 / PK63 / PK75
HNB: PK90

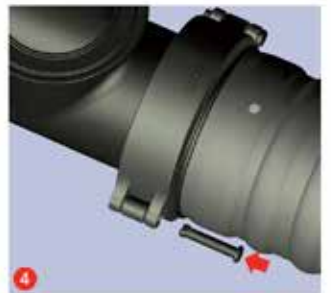
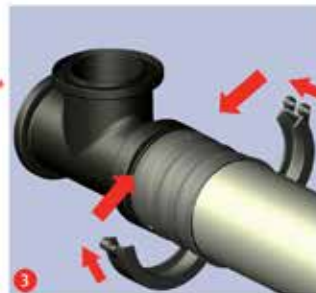
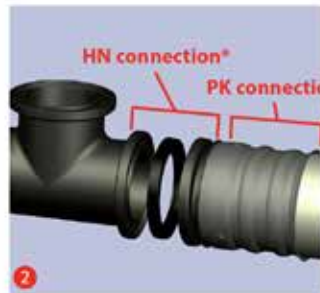



A = 75mm | B = 90 mm

Type: 1HN



Elbow 90°
Codo 90°
Joelho de 90°

Article number	Bag / Box	Type
1HNA	1 pc. / 10 pc.	HNAXHNA
1HNB	1 pc. / 1 pc.	HNBxHNB

Type: 9HN



T-piece
Te
Tê

Article number	Bag / Box	Type
9HNA	1 pc. / 7 pc.	HNAXHNAXHNA
9HNB	1 pc. / 1 pc.	HNBxHNBxHNB

Type: 16HN



Reducing coupling
Reduccion
Redução

Article number	Bag / Box	Type
16HNBA	1 pc. / 15 pc.	HNBxHNA

Type: 27HN



Elbow 45°
Codo 45°
Joelho de 45°

Article number	Bag / Box	Type
27HNA	1 pc. / 15 pc.	HNAXHNA
27HNB	1 pc. / 1 pc.	HNBxHNB

Type: 8HN



Pressfitting
Racor prensado
Casquilho press 63mm

Article number	Bag / Box	Type
8HNA-PK32	1 pc. / 20 pc	HNAX32
8HNA-PK40	1 pc. / 20 pc.	HNAX40
8HNA-PK50	1 pc. / 15 pc.	HNAX50
8HNA-PK63	1 pc. / 12 pc.	HNAX63
8HNA-PK75	1 pc. / 12 pc.	HNAX75
8HNB-PK90	1 pc. / 4 pc.	HNBx90



E. SUPER SIZES

A = 75mm | B = 90 mm

Type: HN



Bracket set
Juego de soportes
Kit de apoio

Article number	Bag / Box	Type
HNA	1 pc. / 1 pc.	
HNB	1 pc. / 1 pc.	

Type: HN-PEN



Locking pin
Clavija de cierre
Pino de bloqueio

Article number	Bag / Box	Type
HN-PEN	50 pc. / 50 pc.	HNA / HNB

Type: HN-U



Sealing ring
Junta de estanqueidad
Junta estanque

Article number	Bag / Box	Type
HNA-U	10 pc. / 10 pc.	HNA
HNB-U	10 pc. / 10 pc.	HNB

Type: 17HN (CW617)



Brass adapter male
Racor macho latón
Casquilho latão macho

Article number	Bag / Box	Type
17HNA-10	1 pc. / 22 pc.	HNAx2"
17HNA-12	1 pc. / 18 pc.	HNAx2 1/2"

Type: 17HN-N (CW602)



Brass adapter male
Racor macho latón
Casquilho latão macho

Article number	Bag / Box	Type
17HNA-10-N	1 pc. / 22 pc.	HNAx2"
17HNA-12-N	1 pc. / 18 pc.	HNAx2 1/2"

Type: 18HN (CW617)



Brass adapter female
Racor hembra latón
Casquilho latao fêmea

Article number	Bag / Box	Type
18HNA-06	1 pc. / 40 pc.	HNAx1"
18HNA-10	1 pc. / 27 pc.	HNAx2"
18HNA-12	1 pc. / 16 pc.	HNAx2 1/2"
18HNB-14	1 pc. / 12 pc.	HNBx3"



A = 75mm | B = 90 mm

Type: 18HN-N (CW602)



Brass adapter female
Racor hembra latón
Casquilho latao fêmea

Article number	Bag / Box	Type
18HNA-06-N	1 pc. / 40 pc.	HNAx1"
18HNA-10-N	1 pc. / 27 pc.	HNAx2"
18HNA-12-N	1 pc. / 16 pc.	HNAx2 1/2"
18HNB-14-N	1 pc. / 12 pc.	HNBx3"

Type: HN-STOP



Stop end for Super Sizes range
Tapón, gama Super Sizes
Tampão, grandes diâmetros

Article number	Bag / Box	Type
HNA-STOP	1 pc. / 90 pc.	HNA
HNA-STOP	1 pc. / 90 pc.	HNA

Type: HN-STOP-E



Stop end for Super Sizes range
Tapón, gama Super Sizes
Tampão, grandes diâmetros

Article number	Bag / Box	Type
HNA-STOP-E	1 pc. / 90 pc.	HNA

Type: HNA-EK05 (CW625N)



Adapter HNA x EK 3/4"
Adaptador HNA x EK 3/4"
Adaptador HNA x EK 3/4

Article number	Bag / Box	Type
HNA-EK05	1 pc. / 50 pc.	HNA x 3/4" EK

Type: HNA-COMP



Expansion bellow
Racor de dilatacion con conexión hna
Acessório de expansão com ligação hna

Article number	Packing	Type
HNA-COMP	1 pc	HNA

Type: HNAFL



Flange connection
Conexión con brida
Ligação com flange

Article number	Packing	Type
HNAFL-DN50	1 pc.	75xDN50

1

2

3

4

5

6

7

8

9

10

11

12



F. HENCO ECOLINE

Type: HNA-ECOLINE-SET



Basic set for Inliner
Conjunto básico para interior
Conjunto básico para Inliner

Article number	Bag / Box	Type
HNA-ECOLINE-SET	1 pc. / -	HNA

composition:

- 1x 9HNA (T-piece)
- 4x HNA (Bracket set)
- 1x HNA-EK05 (Adapter HNA-EK)
- 1x HNA-INLB (Base plate for inliner)

The Henco ECO-line is an energy saving solution for recirculation loops, which limits heat loss between supply and return pipe.

A separate pipe for the circulation water is no longer required.

Designed on the Henco Super Size concept, it also combines modularity and easy installation.

ONE CONCEPT FOR ALL DIMENSIONS FROM 40 UP TO 75MM

- Cost effective
- Easy installation
- Less space consumption
- Anti legionellosis

Necessary items to complete the ECOLINE installation *

Article number	Description	Page
8HNA-PK...	Press fitting 40, 50, 63 or 75	54
50-MXC1620	Henco 1L PE-Xc 16x2 - 100m	-
19P-1605	Nickel plated press-fit adapter to eurocone 16x3/4"	77
19P-2005	Nickel plated press-fit adapter to eurocone 20x3/4"	77
33P-1605	Nickel plated press-fit adapter to eurocone 90°	81
19PK-1605	Press fit swivel to eurocone 16x3/4"	30
19PK-2005	Press fit swivel to eurocone 20x3/4"	30
19SK-1605	Push fitting with eurocone connection 16x3/4"	63
19SK-2005	Push fitting with eurocone connection 20x3/4"	63



* To complete the Ecoline installation you need to have a circulator and thermostatic balancing valve (not in Henco range)



	<i>Page</i>
A. SK	64
B. MANIFOLDS	70



A. SK

Type: 1SK



Elbow 90°
Codo 90°
90° Joelho

Article number	Bag / Box	Type
1SK-1616	10 pc. / 70 pc.	16x16
1SK-2020	10 pc. / 50 pc.	20x20
1SK-2626	5 pc. / 40 pc.	26x26

Type: 2SK



Backplate elbow female
Codo con soporte, rosca hembra
Adaptador fixo fêmea com placa

Article number	Bag / Box	Type
2SK-1604BP*	10 pc. / 40 pc.	16x1/2" (56 mm)
2SK-2004BP*	10 pc. / 40 pc.	20X1/2" (56 mm)
2SK-2005	10 pc. / 30 pc.	20X3/4" (56 mm)
2SK-2605	5 pc. / 20 pc.	26X3/4" (56 mm)

* With black plug BP04 1/2"

Type: 2S



Backplate elbow female, short model
Codo con soporte, rosca hembra, corto
Joelho com suporte, rosca fêmea (curto)

Article number	Bag / Box	Type
2S-1604K	10 pc. / 50 pc.	16x1/2" (43 mm)

Accessory 2PK & 2PK-K: galvanised bracket plate - see page 160

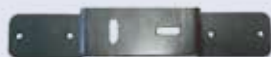

PLP-P-PK



PLF-P-PK

Type: 3SK



Double backplate elbow female, short model
Doble Codo con soporte, rosca hembra, corto
Joelho duplo com rosca fêmea, modelo curto

Article number	Bag / Box	Type
3SK-160416BP *	10 pc. / 30 pc.	16X1/2" (40 mm)
3SK-200420BP *	10 pc. / 30 pc.	20X1/2" (40 mm)

* With black plug BP04 1/2"



Type: 5SK



PK-TOOL p 157

Bend 90° male adapter
Codo 90° rosca macho
Joelho rosca macho 90°

Article number	Bag / Box	Type
5SK-1604	10 pc. / 60 pc.	16X1/2"
5SK-2004	10 pc. / 50 pc.	20X1/2"
5SK-2005	10 pc. / 40 pc.	20X3/4"
5SK-2605	5 pc. / 30 pc.	26X3/4"

Type: 6SK



PK-TOOL p 157

Bend 90° female adapter
Codo 90° rosca hembra
Joelho rosca fêmea 90°

Article number	Bag / Box	Type
6SK-1604BP *	10 pc. / 60 pc.	16X1/2"
6SK-2004BP *	10 pc. / 60 pc.	20X1/2"
6SK-2005	10 pc. / 30 pc.	20X3/4"
6SK-2605	10 pc. / 30 pc.	26X3/4"

* With black plug BP04 1/2"

Type: 9SK



T-piece

Te

Tê

Article number	Bag / Box	Type
9SK-161616	10 pc. / 40 pc.	16x16x16
9SK-202020	10 pc. / 30 pc.	20x20x20
9SK-262626	5 pc. / 20 pc.	26x26x26

Type: 10SK



T-reduced centre

Te con centro reducido

Tê de redução ao centro

Article number	Bag / Box	Type
10SK-201620	10 pc. / 40 pc.	20x16x20
10SK-261626	5 pc. / 25 pc.	26x16x26
10SK-262026	5 pc. / 20 pc.	26x20x26



A. SK

1 Type: 11SK



T-branch and line reduced

Te reducida

Tê de redução 2x

Article number	Bag / Box	Type
11SK-201616	10 pc. / 40 pc.	20x16x16
11SK-202016	10 pc. / 30 pc.	20x20x16
11SK-261620	5 pc. / 25 pc.	26x16x20
11SK-262016	5 pc. / 25 pc.	26x20x16
11SK-262020	5 pc. / 25 pc.	26x20x20
11SK-262616	5 pc. / 25 pc.	26x26x16
11SK-262620	5 pc. / 20 pc.	26x26x20

8 Type: 12SK



T-enlarged branch

Te ampliación centro

Tê extensão central

Article number	Bag / Box	Type
12SK-162016	10 pc. / 40 pc.	16x20x16
12SK-202620	5 pc. / 30 pc.	20x26x20

Type: 13SK



T-female centre

Te, rosca hembra centro

Tê fêmea rosca centro

Article number	Bag / Box	Type
13SK-160416BP *	10 pc. / 40 pc.	16x1/2"x16
13SK-200420BP *	10 pc. / 30 pc.	20x1/2"x20
13SK-200520	10 pc. / 30 pc.	20x3/4"x20
13SK-260420BP *	5 pc. / 20 pc.	26x1/2"x20
13SK-260426BP *	5 pc. / 20 pc.	26x1/2"x26
13SK-260526	5 pc. / 20 pc.	26x3/4"x26

* With black plug BP04 1/2"



PK-TOOL p 157

Type: 14SK



T-male centre

Te, rosca macho centro

Tê, macho centro

Article number	Bag / Box	Type
14SK-160416	10 pc. / 40 pc.	16x1/2"x16
14SK-200420	10 pc. / 30 pc.	20x1/2"x20
14SK-260426	5 pc. / 20 pc.	26x1/2"x26



PK-TOOL p 157

**Type: 15SK**

Straight coupling
Manguito
União

Article number	Bag / Box	Type
15SK-1616	10 pc. / 70 pc.	16x16
15SK-2020	10 pc. / 60 pc.	20x20
15SK-2626	5 pc. / 30 pc.	26x26

Type: 16SK

Reducing coupling
Manguito reducción
Redução

Article number	Bag / Box	Type
16SK-2016	10 pc. / 80 pc.	20x16
16SK-2616	10 pc. / 50 pc.	26x16
16SK-2620	10 pc. / 40 pc.	26x20

Type: 17SK

PK-TOOL p 160

Straight male adapter
Racor recto macho
Encaixe macho fixo

Article number	Bag / Box	Type
17SK-1603	10 pc. / 80 pc.	16x3/8"
17SK-1604	10 pc. / 80 pc.	16x1/2"
17SK-2004	10 pc. / 60 pc.	20x1/2"
17SK-2005	10 pc. / 60 pc.	20x3/4"
17SK-2605	10 pc. / 40 pc.	26x3/4"
17SK-2606	10 pc. / 40 pc.	26x1"

Type: 18SK

PK-TOOL p 157

Straight female adapter
Racor recto hembra
Encaixe fixo fêmea

Article number	Bag / Box	Type
18SK-1604	10 pc. / 80 pc.	16x1/2"
18SK-2004	10 pc. / 80 pc.	20x1/2"
18SK-2005	10 pc. / 60 pc.	20x3/4"
18SK-2605	10 pc. / 50 pc.	26x3/4"
18SK-2606	10 pc. / 40 pc.	26x1"



A. SK

1 Type: 17SKS

2

3

4

5

6

7



Straight nipple male (brass)

Racor recto macho

Encaixe macho

Article number	Bag / Box	Type
17SKS-2004	5 pc. / 150 pc.	20x1/2"
17SKS-2005	5 pc. / 150 pc.	20x3/4"
17SKS-2604	5 pc. / 100 pc.	26x1/2"
17SKS-2605	5 pc. / 100 pc.	26x3/4"

Applicable with HENCO Full Flow Manifold

8 Type: 18SKS

9

10

11

12



Straight nipple female (brass)

Racor recto hembra

Encaixe fêmea

Article number	Bag / Box	Type
18SKS-2004	5 pc. / 150 pc.	20x1/2"
18SKS-2005	5 pc. / 100 pc.	20x3/4"
18SKS-2604	5 pc. / 100 pc.	26x1/2"
18SKS-2605	5 pc. / 80 pc.	26x3/4"

Applicable with HENCO Full Flow Manifold

Type: 19SK



Push fitting with eurocone connection

Racor pushfit con eurocono

Encaixe pushfit com Eurocone

Article number	Bag / Box	Type
19SK-1505	10 pc. / 80 pc.	15x3/4")
19SK-1605	10 pc. / 80 pc.	16x3/4"
19SK-2005	10 pc. / 80 pc.	20x3/4"

Type: 26SK



Push fitting with swivel and flat sealing

Racor pushfit con junta giratoria y plana

Acessório pushfit estanque

Article number	Bag / Box	Type
26SK-1605	10 pc. / 80 pc.	16x3/4"
26SK-2005	10 pc. / 80 pc.	20x3/4"



Type: SK-PIPESTOP



Stop end for pipe
Tapón para tubo
Tampão final para tubo

Article number	Bag / Box	Type
SK-PIPESTOP16	10 pc. / 120 pc.	16
SK-PIPESTOP20	10 pc. / 80 pc.	20
SK-PIPESTOP26	10 pc. / 80 pc.	26

Type: SK-STOPCLIP



Reusable stop and clip for push fit connection
Tapón para accesorio pushfit
Tampão para acessórios Pushfit

Article number	Bag / Box	Type
SK-STOPCLIP16	10 pc. / 120 pc.	16
SK-STOPCLIP20	10 pc. / 100 pc.	20
SK-STOPCLIP26	10 pc. / 80 pc.	26

Type: VISION SET



Vision revision set
Juego revisión Vision
Kit revisão Vision

Article number	Bag / Box	Type
VISION SET 16	1 pc. / 100 pc.	16
VISION SET 20	1 pc. / 90 pc.	20
VISION SET 26	1 pc. / 80 pc.	26

Type: VISION KEY



Vision disassembly key
Llave de desmontaje Vision
Chave de desmontagem Vision

Article number	Bag / Box	Type
VISION-KEY16	1 pc. / 200 pc.	16
VISION-KEY20	1 pc. / 200 pc.	20
VISION-KEY26	1 pc. / 200 pc.	26



B. MANIFOLDS

1

Type: VSK-1616

2

3

4

5

6



Extension or body for manifold, two SK connections Ø16
 Prolongación o cuerpo para colector, dos conexiones SK Ø16
 Coletor sintético 2 saídas SK 16

Article number	Bag / Box	Type
VSK-1616	1 pc. / 14 pc.	1616

7

Type: VSK-161616

8

9

10

11

12



Extension or body for manifold, three SK connections Ø16
 Prolongación o cuerpo para colector, tres conexiones SK Ø16
 Coletor sintético 3 saídas SK 16

Article number	Bag / Box	Type
VSK-161616	1 pc. / 14 pc.	161616

Type: SK-B05



Bracket for Full Flow Manifolds
 Soporte para colectores
 Suporte para Coletores

Article number	Bag / Box	Typ
SK-B05	1 pc. / 200 pc.	B05

Type: VB-EK05



Ball valve, 2 x eurocone connection
 Válvula esfera, 2 x conexión Eurocono
 válvula de esfera, ligação Eurocone

Article number	Box / Big Box	Type
VB-EK05	25 pc. / 200 pc.	3/4" EK x 3/4" EK

See chapter 6A for more options for the Full Flow Manifold

BRASS PRESS FITTINGS - RACORES DE LATÓN ACESSÓRIOS PRESS DE LATÃO



	<i>Page</i>
A.P	72
B.PG	84



A. P

Type: 1P



Elbow 90°

Codo 90°

Joelho de 90°

Article number	Bag / Box	Type
1P-1616	10 pc. / 150 pc.	16x16
1P-1818	10 pc. / 100 pc.	18x18
1P-2020	10 pc. / 80 pc.	20x20
1P-2626	5 pc. / 50 pc.	26x26
1P-3232	5 pc. / 50 pc.	32x32

Type: 2P



Backplate elbow female

Codo con soporte rosca hembra

Joelho com pater, rosca fêmea

Article number	Bag / Box	Type
2P-1604	10 pc. / 50 pc.	16x1/2" (52 mm)
2P-1804	10 pc. / 50 pc.	18x1/2" (52 mm)
2P-2004	10 pc. / 50 pc.	20x1/2" (52 mm)
2P-2005	10 pc. / 50 pc.	20x3/4" (52 mm)
2P-2605	5 pc. / 50 pc.	26x3/4" (52 mm)

Type: 2P-K



Backplate elbow female, short model

Codo con soporte rosca hembra corto

Joelho com pater, rosca fêmea curta

Article number	Bag / Box	Type
2P-1404K	10 pc. / 50 pc.	14x1/2" (35 mm)
2P-1604K	10 pc. / 50 pc.	16x1/2" (35 mm)

Type: 3P



Double backplate elbow female

Doble Codo con soporte, rosca hembra

Cotovelo duplo de contra-capta feminino

Article number	Bag / Box	Type
3P-160416	10 pc. / 40 pc.	16x1/2"x16 (52 mm)
3P-200420	10 pc. / 40 pc.	20x1/2"x20 (52 mm)

Type: 3P-VK



Double backplate female (flow), short model

Doble Codo con soporte, rosca hembra, corto

Joelho duplo com suporte, rosca fêmea

Article number	Bag / Box	Type
3P-160416VK	5 pc. / 20 pc.	16x1/2"x16 (40 mm)
3P-200420VK	5 pc. / 20 pc.	20x1/2"x20 (40 mm)
3P-260426VK	5 pc. / 20 pc.	26x1/2"x26 (40mm)



Accessory for 2P, 2P-K, 3P-VK, 4P:
galvanised bracket plate - see
page 160



PLP-P-PK



PLF-P-PK

Type: 4P

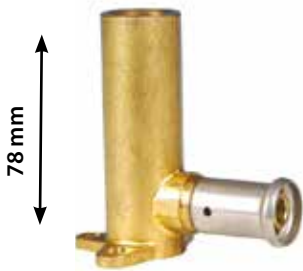

Backplate elbow female, extended model

Codo con soporte, rosca hembra, modelo extendido

Joelho pater, rosca fêmea, modelo alargado

Article number	Bag / Box	Type
4P-1604	10 pc. / 40 pc.	16x1/2" (78 mm)
4P-2004	10 pc. / 40 pc.	20x1/2" (78 mm)

Type: 5P



Bend 90° male adapter

Codo 90° rosca macho

Joelho macho de 90°

Article number	Bag / Box	Type
5P-1603	10 pc. / 150 pc.	16x3/8"
5P-1603DZR *	10 pc. / 150 pc.	16x3/8"
5P-1604	10 pc. / 150 pc.	16x1/2"
5P-1604DZR *	10 pc. / 150 pc.	16x1/2"
5P-1804	10 pc. / 120 pc.	18x1/2"
5P-2004	10 pc. / 100 pc.	20x1/2"
5P-2005	10 pc. / 80 pc.	20x3/4"
5P-2605	10 pc. / 60 pc.	26x3/4"
5P-3206 **	5 pc. / 25 pc.	32x1"

* DZR = Brass alloy CW602N"

**TILL EXHAUSTION OF STOCK

Type: 6P



Bend 90° female adapter

Codo 90° rosca hembra

Joelho rosca fêmea 90°

Article number	Bag / Box	Type
6P-1604	10 pc. / 120 pc.	16x1/2"
6P-1804	10 pc. / 120 pc.	18x1/2"
6P-2004	10 pc. / 120 pc.	20x1/2"
6P-2005	10 pc. / 50 pc.	20x3/4"
6P-2605	5 pc. / 50 pc.	26x3/4"

Type: 7P



Backplate elbow male

Codo con soporte, rosca macho

Joelho com rosca macho - suporte simples

Article number	Bag / Box	Type
7P-1605	10 pc. / 30 pc.	16x3/4" (78 mm)
7P-1605K	5 pc. / 30 pc.	16x3/4" (60 mm)
7P-1605L	5 pc. / 30 pc.	16x3/4" (70 mm)



A. P

1 Type: 8P



Sanitary adapter female
 Conexión para lavadora
 Ligação máquina de lavar roupa

Article number	Bag / Box	Type
8P-1604	10 pc. / 50 pc.	16x1/2"

6 Type: 9P



T-piece
 Te
 Tê

Article number	Bag / Box	Type
9P-161616	10 pc. / 60 pc.	16x16x16
9P-181818	10 pc. / 60 pc.	18x18x18
9P-202020	10 pc. / 50 pc.	20x20x20
9P-262626	5 pc. / 30 pc.	26x26x26
9P-323232	1 pc. / 20 pc.	32x32x32

11 Type: 10P



T-reduced centre
 Té reducida
 Tê de redução

Article number	Bag / Box	Type
10P-181618	10 pc. / 50 pc.	18x16x18
10P-201620	10 pc. / 50 pc.	20x16x20
10P-261626	5 pc. / 30 pc.	26x16x26
10P-262026	5 pc. / 30 pc.	26x20x26
10P-321632	5 pc. / 20 pc.	32x16x32
10P-322032	5 pc. / 20 pc.	32x20x32
10P-322632	5 pc. / 20 pc.	32x26x32

Type: 11P



T-branch and line reduced
 Te reducida
 Tê de redução 2x

Article number	Bag / Box	Type
11P-201616	10 pc. / 50 pc.	20x16x16
11P-202016	10 pc. / 50 pc.	20x20x16
11P-261620	5 pc. / 30 pc.	26x16x20
11P-262020	5 pc. / 30 pc.	26x20x20
11P-262616	5 pc. / 30 pc.	26x26x16
11P-262620	5 pc. / 30 pc.	26x26x20
11P-322026	5 pc. / 20 pc.	32x20x26
11P-322626	5 pc. / 20 pc.	32x26x26

**Type: 12P**
T-enlarged branch
Te, ampliación centro
Tê Centro

Article number	Bag / Box	Type
12P-162016	10 pc. / 60 pc.	16x20x16
12P-202620	5 pc. / 30 pc.	20x26x20
12P-263226	5 pc. / 20 pc.	26x32x26

Type: 13P
T-female centre branch
Te rosca hembra centro
Tê fêmea

Article number	Bag / Box	Type
13P-160416	10 pc. / 60 pc.	16x1/2"x16
13P-200420	10 pc. / 50 pc.	20x1/2"x20
13P-200520	10 pc. / 30 pc.	20x3/4"x20
13P-260426	5 pc. / 30 pc.	26x1/2"x26
13P-260526	5 pc. / 30 pc.	26x3/4"x26
13P-320532	5 pc. / 20 pc.	32x3/4"x32

Type: 14P
T-male centre branch
Te rosca macho centro
Tê, macho

Article number	Bag / Box	Type
14P-160416	10 pc. / 60 pc.	16x1/2"x16
14P-200420	10 pc. / 60 pc.	20x1/2"x20
14P-200520	5 pc. / 30 pc.	20x3/4"x20
14P-260426	5 pc. / 30 pc.	26x1/2"x26

Type: 15P
Straight coupling
Manguito
União

Article number	Bag / Box	Type
15P-1414	10 pc. / 200 pc.	14x14
15P-1616	10 pc. / 200 pc.	16x16
15P-1818	10 pc. / 150 pc.	18x18
15P-2020	10 pc. / 140 pc.	20x20
15P-2626	5 pc. / 80 pc.	26x26
15P-3232	5 pc. / 50 pc.	32x32



A. P

1 Type: 16P

2

3

4

5

6

7

8



Reducing coupling Manguito reducción União redução

Article number	Bag / Box	Type
16P-1614	10 pc. / 150 pc.	16x14
16P-1816	10 pc. / 150 pc.	18x16
16P-2016	10 pc. / 150 pc.	20x16
16P-2018	10 pc. / 150 pc.	20x18
16P-2616	5 pc. / 100 pc.	26x16
16P-2620	5 pc. / 80 pc.	26x20
16P-3216	5 pc. / 60 pc.	32x16
16P-3220	5 pc. / 60 pc.	32x20
16P-3226	5 pc. / 60 pc.	32x26

9 Type: 17P

10

11

12



Straight male adapter Racor fijo macho Casquilho macho fixo

Article number	Bag / Box	Type
17P-1603	10 pc. / 150 pc.	16x3/8"
17P-1603DZR	10 pc. / 150 pc.	16x3/8"
17P-1604	10 pc. / 150 pc.	16x1/2"
17P-1604DZR	10 pc. / 150 pc.	16x1/2"
17P-1605	10 pc. / 150 pc.	16x3/4"
17P-1804	10 pc. / 150 pc.	18x1/2"
17P-1805	10 pc. / 150 pc.	18x3/4"
17P-2004	10 pc. / 150 pc.	20x1/2"
17P-2005	10 pc. / 150 pc.	20x3/4"
17P-2605	5 pc. / 80 pc.	26x3/4"
17P-2606	5 pc. / 80 pc.	26x1"
17P-3206	5 pc. / 50 pc.	32x1"
17P-3207	5 pc. / 40 pc.	32x1 1/4"

Type: 18P



Straight female adapter Racor fijo hembra Casquilho fêmea fixo

Article number	Bag / Box	Type
18P-1604	10 pc. / 150 pc.	16x1/2"
18P-1804	10 pc. / 120 pc.	18x1/2"
18P-2004	10 pc. / 100 pc.	20x1/2"
18P-2005	10 pc. / 100 pc.	20x3/4"
18P-2605	5 pc. / 80 pc.	26x3/4"
18P-2606	5 pc. / 70 pc.	26x1"
18P-3206	5 pc. / 50 pc.	32x1"
18P-3207	5 pc. / 30 pc.	32x1 1/4"



Type: 19P



Press-fit adapter to eurocone
Adaptador prensado a eurocono
Adaptador de encaixe Eurocone niquelado

Article number	Bag / Box	Type
19P-1405	10 pc. / 150 pc.	14x3/4"
19P-1605	10 pc. / 150 pc.	16x3/4"
19P-1805	10 pc. / 150 pc.	18x3/4"
19P-2005	10 pc. / 140 pc.	20x3/4"

Type: 24P



Radiator connection nickel-plated 300 mm copper pipe Ø15
Conexión a radiador en cobre niquelado Ø 15 mm, de 300 mm
Ligação radiador cobre niquelado, Ø 15 mm, 300 mm

Article number	Bag / Box	Type
24P-1604	2 pc. / 50 pc.	16x15Cu
24P-2004	2 pc. / 50 pc.	20x15Cu

Type: 25P



Radiator connection nickel-plated 1100 mm copper pipe Ø15
Conexión a radiador en cobre niquelado Ø 15 mm, de 1100 mm
Ligação radiador cobre niquelado Ø 15 mm, 1100 mm

Article number	Tasche	Type
25P-1604	2 pc.	16x15Cu

Type: 26P



Union with flat seat
Manguito tuerca loca
União com porca louca

Article number	Bag / Box	Type
26P-1604	10 pc. / 100 pc.	16x1/2"
26P-1605	10 pc. / 80 pc.	16x3/4"
26P-2004	10 pc. / 80 pc.	20x1/2"
26P-2005	10 pc. / 70 pc.	20x3/4"
26P-2605	5 pc. / 50 pc.	26x3/4"
26P-2606	5 pc. / 40 pc.	26x1"
26P-3206	5 pc. / 40 pc.	32x1"

Type: 26P-Z



Press fitting swivel adapter
Manguito tuerca loca (sin machón)
União porca louca

Article number	Bag / Box	Type
26P-16Z03	10 pc. / 150 pc.	16x3/8"
26P-16Z04	10 pc. / 150 pc.	16x1/2"
26P-16Z05	10 pc. / 80 pc.	16x3/4"
26P-20Z04	10 pc. / 150 pc.	20x1/2"
26P-20Z05	10 pc. / 70 pc.	20x3/4"
26P-26Z05	5 pc. / 50 pc.	26x3/4"
26P-26Z06	5 pc. / 40 pc.	26x1"
26P-32Z06	5 pc. / 40 pc.	32x1"
26P-32Z07	5 pc. / 40 pc.	32x1 1/4"



A. P

Type: N



Nipple for 26P-Z

Machón adaptador para 26P-Z

Abraçadeira adaptadora para 26P-Z

Article number	Bag / Box	Type
N04	10 pc. / 250 pc.	1/2"x3/4"
N05	10 pc. / 200 pc.	3/4"x3/4"
N06	25 pc. / 250 pc	1"x1"

Type: 27P



45° bend

Codo 45°

Joelho de 45°

Article number	Bag / Box	Type
27P-2626	5 pc. / 50 pc.	26x26
27P-3232	5 pc. / 30 pc.	32x32

Type: 28P



Double backplate elbow female, build-up

Doble codo con soporte, rosca hembra, con distanciador

Joelho duplo com suporte, rosca fêmea, com distanciador

Article number	Bag / Box	Type
28P-14041604-1	1 pc. / 20 pc.	14x1/2"x16x1/2" (153 mm)
28P-16041604-1	1 pc. / 20 pc.	16x1/2"x16x1/2" (153 mm)

Type: 28PV



Double backplate elbow female, build-in

Doble codo con soporte, rosca hembra, con distanciador elevado

Joelho duplo com suporte, rosca fêmea, com distanciador elevado

Article number	Bag / Box	Type
28PV-16031603-1	1 pc. / 15 pc.	16x3/8"x16x3/8" (120 mm)
28PV-16041604-1	1 pc. / 15 pc.	16x1/2"x16x1/2" (153 mm)

Type: 28PF



Double backplate elbow female for plaster

Doble codo con soporte, rosca hembra, para enlucido

Joelho duplo com suporte, rosca fêmea, para reboco

Article number	Bag / Box	Type
28PF-16041604	1 pc. / 1 pc.	16x1/2"x16x1/2"
28PF-20042004	1 pc. / 1 pc.	20x1/2"x20x1/2"



Type: 29P-CS (CW724)



Press-fit adapter with copper pipe
Manguito a pensar con tubo cobre soldado
União prensada com tubo de cobre soldado

Article number	Bag / Box	Type
29P-1612-CS	10 pc. / 120 pc.	16x12 (50mm copper)
29P-1615-CS	10 pc. / 120 pc.	16x15 (50mm copper)
29P-2018-CS	10 pc. / 70 pc.	20x18 (50mm copper)
29P-2022-CS	10 pc. / 70 pc.	20x22 (50mm copper)
29P-2622-CS	10 pc. / 70 pc.	26x22 (50mm copper)

Type: 30P



Press-fit adapter to copper compression
Conexión a prensado - Tubo de cobre compresión
Ligação press - compressão do tubo de cobre

Article number	Bag / Box	Type
30P-1614S	10 pc. / 120 pc.	16x14 Cu
30P-1615S-2	2 pc. / 100 pc.	16x15 Cu
30P-2022S	10 pc. / 100 pc.	20x22 Cu
30P-2622S	10 pc. / 80 pc.	26x22 Cu

Type: 31P



Double crossover tee, nickel plated
Doble te en cruz
Tê duplo cruz

Article number	Bag / Box	Type
31P-161616	1 pc. / 20 pc.	16x16x16
31P-201616	1 pc. / 20 pc.	20x16x16
31P-201620	1 pc. / 20 pc.	20x16x20
31P-202020	1 pc. / 20 pc.	20x20x20

Type: ISO-BOX



Insulation box for double crossover tee
Caja aislante para doble te en cruz
Caixa isolante para Tê com dupla cruz

Article number	Box	Type
ISO-BOX	1 pc.	124x124x55mm

Type: 33P



Nickel plated press-fit adapter to eurocone, 90°
Adaptador prensado niquelado a eurocono, 90°
Adaptador Eurocone 90° niquelado

Article number	Bag / Box	Type
33P-1605	10 pc. / 60 pc.	16x3/4"



A. P

Type: 34P



Henco press swivel adapter with flat sealing, 90°
 Adaptador Henco prensado a tuerca loca con junta plana, 90°
 Adaptador Henco press-fit porca com junta plana, 90

Article number	Bag / Box	Type
34P-1604	10 pc. / 120 pc.	16x1/2"
34P-3206	5 pc. / 40 pc.	32x1"

Type: 34P-CS (CW724)



Henco press swivel adapter with flat sealing, 90°
 Adaptador Henco prensado a tuerca loca con junta plana, 90°
 Adaptador Henco press-fit porca com junta plana, 90

Article number	Bag / Box	Type
34P-1605-CS	10 pc. / 120 pc.	16x3/4"
34P-2004-CS	10 pc. / 80 pc.	20x1/2"
34P-2005-CS	10 pc. / 80 pc.	20x3/4"
34P-2605-CS	10 pc. / 70 pc.	26x3/4"

Type: 35P



Press-fit adapter to copper press (M-profile)
 Adaptador Henco prensado a cobre press (perfil M)
 Adaptador Henco press-fit para cobre (perfil M)

Article number	Bag / Box	Type
35P-1615P	10 pc. / 150 pc.	16x15Cu M-profile
35P-2022P	10 pc. / 80 pc.	20x22Cu M-profile
35P-3228P	5 pc. / 50 pc.	32x28Cu M-profile

TILL EXHAUSTION OF STOCK

Type: 36P (CW724)



Press-fit adapter to copper press or thin steel (V, M & SA-profile)
 Adaptador Henco prensado a cobre press
 Adaptador Henco press-fit para cobre

Article number	Bag / Box	Type
36P-1612P	10 pc. / 160 pc.	16x12Cu
36P-1614P	10 pc. / 150 pc.	16x14Cu
36P-1615P	10 pc. / 150 pc.	16x15Cu
36P-1616P	10 pc. / 150 pc.	16x16Cu
36P-2015P	10 pc. / 120 pc.	20x15Cu
36P-2018P	10 pc. / 120 pc.	20x18Cu
36P-2022P	10 pc. / 80 pc.	20x22Cu
36P-2620P	10 pc. / 70 pc.	20x20Cu
36P-2622P	10 pc. / 70 pc.	26x22Cu
36P-2628P	10 pc. / 70 pc.	26x28Cu
36P-3228P	5 pc. / 50 pc.	32x28Cu



Type: 37P

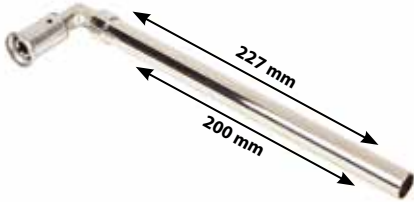

Press-fit adapter to copper pipe, elbow
Codo adaptador para tubería cobre
Joelho adaptador para tubo cobre

Article number	Bag / Box	Type
37P-1412L	10 pc. / 60 pc.	14x12 (227/200mm)
37P-1612L	10 pc. / 60 pc.	16x12 (227/200mm)
37P-1615L	10 pc. / 60 pc.	16x15 (227/200mm)

Type: 39P



Double bend for radiator nickel-plated 300 mm copper pipe Ø15, connected end
Doble curva para radiador, cerrada, en cobre niquelado Ø 15 mm, de 300 mm
Curva dupla para radiador, fechada, em cobre niquelado Ø 15 mm, 300 mm

Article number	Bag / Box	Typ
39P-160450	1 pc. / 8 pc.	16x1/2" (AS = 50 mm)

Interaxis 50 mm

Type: 40P



Press-fit elbow to copper compression
Codo prensado - Tubo de cobre compresión
Joelho press - Tubo compressão de cobre

Article number	Bag / Box	Type
40P-1615S	10 pc. / 60 pc.	16x15 Cu
40P-2022S	10 pc. / 60 pc.	20x22 Cu
40P-2622S	10 pc. / 60 pc.	26x22 Cu

Type: 41P



Brass press coupling with valve F-connection
Manguito prensados de latón con válvula de conexión F
União de latão prems com válvula de ligação Fêmea

Article number	Bag / Box	Type
41P-16	10 pc. / 40 pc.	16
41P-20	10 pc. / 40 pc.	20
41P-26	10 pc. / 40 pc.	26

BA-F41
(p. 109)

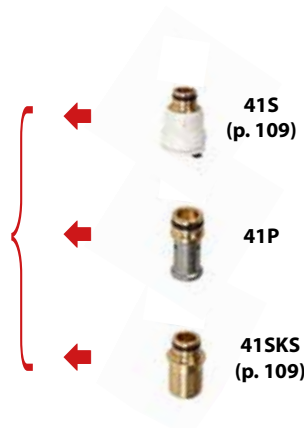



A. P

Type: 42P



Straight coupling PEX
Manguito unión PEX
União 16x PEX

Article number	Bag / Box	Type
42P-161615	10 pc. / 200 pc.	16x16x15
42P-202019	10 pc. / 140 pc.	20x20x19

Type: 43P



T-piece Henco press 16 x compression 15 x Henco press 16
Pieza en T Henco prensado 16mm x compresión 15mm x prensado 16mm
Peça T Henco 16mm x compressão 15mm x prens 16mm

Article number	Bag / Box	Type
43P-161516	2 pc. / 50 pc.	16x15x16

Type: 44P



Bend 90° female connection toilet reservoir
Codo hembra 90° salida 16x1/2" para sistemas suspendidos+a10
Joelho press fêmea a 90° - 16x1/2" para sistemas suspensos

Article number	Bag / Box	Type
44P-1604	10 pc. / 60 pc.	16x1/2"

Type: 45P



Straight connection female toilet reservoir 16x2,0 x 1/2"
Conexión recta hembra del depósito del inodoro 16x2,0 x 1/2"
Reservatório feminino de sanita de ligação recta 16x2,0 x 1/2"

Article number	Bag / Box	Type
45P-1604	10 pc. / 150 pc.	16x1/2"

Type: 52P



Easy mounting/repair fitting
Accesorio manguito de reparación
União de reparação

Article number	Bag / Box	Type
52P16	1 pc. / 40 pc.	16x16
52P20	1 pc. / 30 pc.	20x20
52P26	1 pc. / 30 pc.	26x26
52P32	1 pc. / 30 pc.	32x32

for Ø40, 50 and 63: chapter 2, article 53PK



Type: WALL BOX

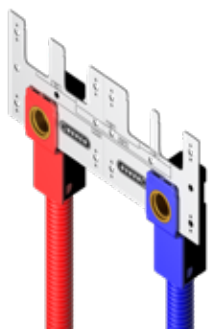

Wall box PRESS

Caja de pared

Caixa de parede 2 par vermelho/azul 1/2 "F x16 mm

Article number	Box / Big box	Type
WBP-1604-RO	10 pc. / 300 pc.	16x1/2"
WBP-1604-BL	10 pc. / 300 pc.	16x1/2"
WBP-2004-RO	10 pc. / 300 pc.	20x1/2"
WBP-2004-BL	10 pc. / 300 pc.	20x1/2"

Without mounting bracket WB-PLATE



Instruction video

Type: WB-PLATE

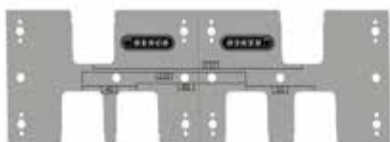

Wall Box mounting bracket

Soporte de montaje Wall Box

Suporte de montagem de caixa de parede em

Article number	Bag / Box	Type
WBPL-X	10 pc. / 60 pc.	

Type: P-PIPESTOP



Stop end press for pipe

Tapón prensado

Tampão final

Article number	Bag / Box	Type
P-PIPESTOP16	10 pc. / 250 pc.	16
P-PIPESTOP20	10 pc. / 200 pc.	20
P-PIPESTOP26	10 pc. / 120 pc.	26
P-PIPESTOP32	10 pc. / 70 pc.	32



B. PG

Gas: only allowed in countries where has been a HENCO GAS testing + certificate is available! (see www.henco.be)
 Gas: solo permitido en países donde se ha realizado una prueba + certificado de HENCO GAS disponible. (ver www.henco.be)
 Gás: permitido apenas em países onde o Henco Gás + o certificado está disponível! (veja www.henco.be)



Henco brass press fittings for gas in combination with standard pipes gas, see page 17

Type: 1PG



Elbow 90°
 Codo 90°
 Joelho de 90°

Article number	Bag / Box	Type
1PG-1616	10 pc. / 150 pc.	16x16
1PG-2020	10 pc. / 80 pc.	20x20
1PG-2626	5 pc. / 50 pc.	26x26
1PG-3232	5 pc. / 50 pc.	32x32

Type: 2PG



Backplate elbow female
 Codo con soporte, rosca hembra
 Joelho com suporte, rosca fêmea

Article number	Bag / Box	Type
2PG-1604	10 pc. / 50 pc.	16x1/2" (52 mm)
2PG-2004	10 pc. / 50 pc.	20x1/2" (52 mm)
2PG-2005	10 pc. / 50 pc.	20x3/4" (52mm)
2PG-2605	5 pc. / 50 pc.	26x3/4" (52 mm)

Type: 2PG-K



Backplate elbow female, short model
 Codo con soporte, rosca hembra corto
 Joelho com suporte, fio fêmea curto

Article number	Bag / Box	Type
2PG-1604K	10 pc. / 50 pc.	16x1/2" (35 mm)

Type: 5PG



Elbow 90° male adapter
 Codo 90° rosca macho
 Joelho rosca macho 90°

Article number	Bag / Box	Type
5PG-1604	10 pc. / 150 pc.	16x1/2"
5PG-2004	10 pc. / 100 pc.	20x1/2"
5PG-2005	10 pc. / 80 pc.	20x3/4"
5PG-2605	10 pc. / 60 pc.	26x3/4"



Type: 6PG



Elbow 90° female adapter
Codo 90° rosca hembra
Joelho rosca fêmea 90°

Article number	Bag / Box	Type
6PG-1604	10 pc. / 120 pc.	16x1/2"
6PG-2004	10 pc. / 120 pc.	20x1/2"
6PG-2005	10 pc. / 50 pc.	20x3/4"
6PG-2605	5 pc. / 50 pc.	26x3/4"

Type: 9PG



T-piece
Te
Tê

Article number	Bag / Box	Type
9PG-161616	10 pc. / 60 pc.	16x16x16
9PG-202020	10 pc. / 50 pc.	20x20x20
9PG-323232 *	1 pc. / 20 pc.	32x32x32

*TILL EXHAUSTION OF STOCK

Type: 10PG



T-reduced centre
Te con centro reducido
Tê de redução ao centro

Article number	Bag / Box	Type
10PG-262026	5 pc. / 30 pc.	26x20x26

Type: 11PG



T-branch and line reduced
Te reducida
Tê de redução 2x

Article number	Bag / Box	Type
11PG-201616	10 pc. / 50 pc.	20x16x16

Type: 13PG



T-female centre
Te rosca hembra centro
Tê fêmea

Article number	Bag / Box	Type
13PG-200420	10 pc. / 50 pc.	20x1/2"x20
13PG-260426	5 pc. / 30 pc.	26x1/2"x26
13PG-260526	5 pc. / 30 pc.	26x3/4"x26



B. PG

1 Type: 15PG

2

3

4

5

6

7



Straight coupling

Manguito

União

Article number	Bag / Box	Type
15PG-1616	10 pc. / 200 pc.	16x16
15PG-2020	10 pc. / 140 pc.	20x20
15PG-2626	5 pc. / 80 pc.	26x26
15PG-3232	5 pc. / 50 pc.	32x32

8 Type: 16PG

8

9

10

11

12



Reducing coupling

Manguito reducción

Redução

Article number	Bag / Box	Type
16PG-2016	10 pc. / 150 pc.	20x16
16PG-2620	5 pc. / 80 pc.	26x20
16PG-3226	5 pc. / 40 pc.	32x26

Type: 17PG



Straight male adapter

Racor recto macho

União rosca macho

Article number	Bag / Box	Type
17PG-1604	10 pc. / 150 pc.	16x1/2"
17PG-2004	10 pc. / 150 pc.	20x1/2"
17PG-2005	10 pc. / 150 pc.	20x3/4"
17PG-2605	5 pc. / 80 pc.	26x3/4"
17PG-2606	5 pc. / 80 pc.	26x1"
17PG-3206	5 pc. / 50 pc.	32x1"



Type: 18PG



Straight female adapter
Racor recto hembra
União roscada fêmea

Article number	Bag / Box	Type
18PG-1604	10 pc. / 150 pc.	16x1/2"
18PG-2004	10 pc. / 100 pc.	20x1/2"
18PG-2005	10 pc. / 100 pc.	20x3/4"
18PG-2605	5 pc. / 80 pc.	26x3/4"
18PG-2606	5 pc. / 50 pc.	26x1"
18PG-3206	5 pc. / 50 pc.	32x1"

Type: 30PG



Press-fit adapter to copper compression
Conexión a prensado - Tubo de cobre compresión
Ligação press - compressão do tubo de cobre

Article number	Bag / Box	Type
30PG-1615S-2	10 pc. / 120 pc.	16x15 Cu
30PG-2022S	10 pc. / 100 pc.	20x22 Cu
30PG-2622S	10 pc. / 80 pc.	26x22 Cu

Type: 36PG



Press-fit adapter to copper press (V, M & SA-profile)
Adaptador Henco prensado a cobre press (perfil V, M y SA)
Adaptador Henco press-fit para cobre (perfil V, M e SA)

Article number	Bag / Box	Type
36PG-1615P	10 pc. / 150 pc.	16x15Cu
36PG-2015P	10 pc. / 120 pc.	20x15Cu
36PG-2022P	10 pc. / 80 pc.	20x22Cu
36PG-2615P	10 pc. / 80 pc.	26x15Cu
36PG-2622P	10 pc. / 70 pc.	26x22Cu

1

2

3

4

5

6

7

8

9

10

11

12

BRASS COMPRESSION FITTINGS - ACCESORIOS DE COMPRESIÓN DE LATÓN - ACESSÓRIOS DE COMPRESSÃO DE LATÃO

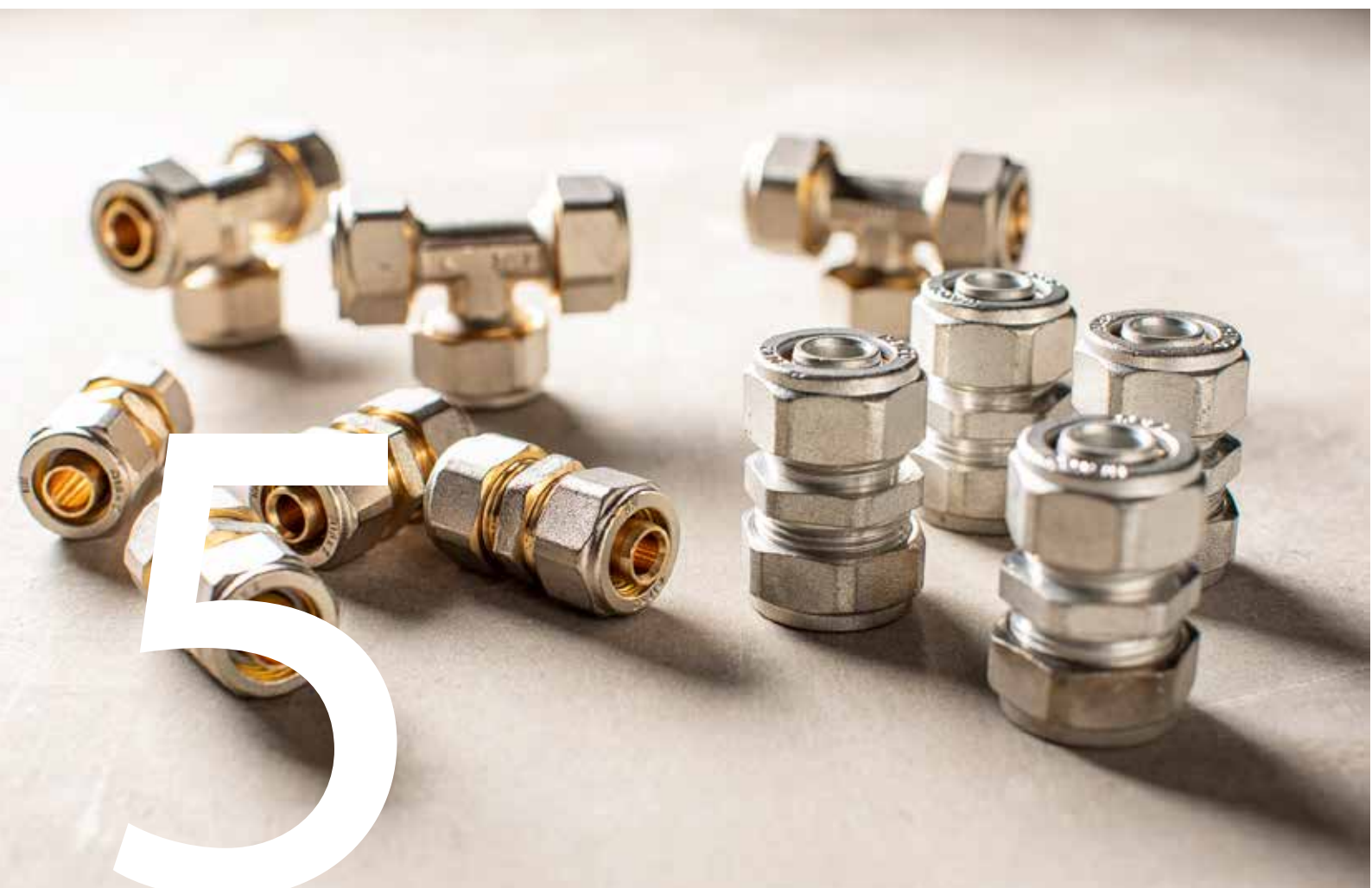



Type: 1



Straight male adapter Racor recto macho Casquilho rosca macho

Article number	Bag / Box	Type
1-1604-S	10 pc. / 180 pc.	16x1/2" + o-ring
1-1604ZA	10 pc. / 250 pc.	16x1/2"
1-1605-S	10 pc. / 150 pc.	16x3/4"
1-1804-S	10 pc. / 150 pc.	18x1/2" + o-ring
1-1805 *	10 pc. / 150 pc.	18x3/4"
1-2004-S	10 pc. / 150 pc.	20x1/2" + o-ring
1-2004-ZS	10 pc. / 150 pc.	20x1/2"
1-2005-S	10 pc. / 150 pc.	20x3/4"
1-2605-S	5 pc. / 80 pc.	26x3/4"
1-2606-S	5 pc. / 80 pc.	26x1"
1-3206-S	5 pc. / 80 pc.	32x1"

* TILL EXHAUSTION OF STOCK

Type: 2



Straight coupling Manguito União

Article number	Bag / Box	Type
2-1616-S	10 pc. / 200 pc.	16x16
2-2020-S	10 pc. / 120 pc.	20x20

Type: 3



Straight female adapter Racor recto hembra União rosca fêmea

Article number	Bag / Box	Type
3-1604-S	10 pc. / 170 pc.	16x1/2"
3-1804-S	10 pc. / 120 pc.	18x1/2"
3-2004-S	10 pc. / 120 pc.	20x1/2"
3-2005-S	10 pc. / 120 pc.	20x3/4"
3-2605-S	5 pc. / 80 pc.	26x3/4"
3-2606-S	5 pc. / 80 pc.	26x1"

Type: 4



Elbow 90° Codo 90° Joelho 90°

Article number	Bag / Box	Type
4-1616-S	10 pc. / 110 pc.	16x16
4-2020-S	10 pc. / 60 pc.	20x20
4-2626-S	10 pc. / 40 pc.	26x26



1

2

3

4

5

Type: 5



Elbow 90° male adapter

Codo 90° rosca macho

Joelho macho 90°

Article number	Bag / Box	Type
5-1604-S	10 pc. / 150 pc.	16x1/2"
5-1804 *	10 pc. / 100 pc.	18x1/2"
5-2005-S	10 pc. / 100 pc.	20x3/4"
5-2606-S	5 pc. / 40 pc.	26x1"

** TILL EXHAUSTION OF STOCK*

6

7

8

9

10

11

Type: 6



Elbow 90° female adapter

Codo 90° rosca hembra

Joelho rosca fêmea 90°

Article number	Bag / Box	Type
6-1604-S	10 pc. / 150 pc.	16x1/2"
6-1804 *	10 pc. / 90 pc.	18x1/2"
6-2005-S	10 pc. / 80 pc.	20x3/4"

** TILL EXHAUSTION OF STOCK*

12

Type: 7



Backplate elbow with branch connection

Codo con soporte rosca hembra

Joelho com rosca fêmea - suporte simples

Article number	Bag / Box	Type
7-1604-S	10 pc. / 80 pc.	16x1/2"
7-2004-S	10 pc. / 60 pc.	20x1/2"

Type: 8



T-piece

Te

Tê

Article number	Bag / Box	Type
8-161616-S	10 pc. / 70 pc.	16x16x16
8-202020-S	10 pc. / 50 pc.	20x20x20

Type: 9



T-female branch

Te rosca hembra centro

Ramo Te Feminino

Article number	Bag / Box	Type
9-160416	10 pc. / 80 pc.	16x1/2"x16
9-200520A	10 pc. / 40 pc.	20x3/4"x20



Type: 10



Nut, insert and jointing ring
Tuerca, inserto y anillo de unión
Porca, inserto e anel de junção

Article number	Bag / Box	Type
10-16045N	10 pc. / 300 pc.	16x1/2"

TILL EXHAUSTION OF STOCK

Type: 13-2



Nut, insert and jointing ring to copper compression
Tuerca, inserto y anillo de unión a compresión de cobre
Porca e anel de compressão de cobre

Article number	Bag / Box	Type
13-1415-2 *	2 pc. / 200 pc.	14x15 Cu
13-1615A-2 *	2 pc. / 200 pc.	16x15 Cu
13-1615HA-2	2 pc. / 200 pc.	16x15 Cu
13-2022HA-2	2 pc. / 120 pc.	20x22 Cu
13-2628H-2	2 pc. / 80 pc.	26x28 Cu

* Nickel plated nut

Type: 13-VH



Adapter for Henco compression 26mm to copper compression 22mm
Adaptador compresión cobre para Henco
Adaptador compressão de cobre Henco

Article number	Bag / Box	Type
13-V2622H-2	2 pc. / 70 pc.	26x22 Cu

Type: 24



Compression coupling Henco x copper tube
Racor recto con tubo de cobre
Encaixe com tubo de cobre

Article number	Bag / Box	Type
24-1615-S	10 pc. / 200 pc.	16x15 Cu
24-2022	10 pc. / 100 pc.	20x22 Cu
24-2622	5 pc. / 50 pc.	26x22 Cu

Type: 28



T-reduced centre
Te reducción centro
Tê redução centro

Article number	Bag / Box	Type
28-201620	5 pc. / 50 pc.	20x16x20



1 **Type: EK**



Nickel plated eurocone (3/4" F)
Racor Eurocono (3/4" F), niquelado
Acessório Eurocone (3/4 "F), niquelado

Article number	Bag / Box	Type
EK12-2	2 pc. / 100 pc.	Ø12
EK14-2	2 pc. / 100 pc.	Ø14
EK16-2	2 pc. / 100 pc.	Ø16
EK17-2	2 pc. / 100 pc.	Ø17
EK18-2	2 pc. / 100 pc.	Ø18
EK20-2	2 pc. / 100 pc.	Ø20

6

7 **Type: EKH**



Brass eurocone (3/4" F)
Racor Eurocono (3/4" F), latón
Acessório Eurocone (3/4 "F), latão

Article number	Bag / Box	Type
EKH16-2	2 pc. / 100 pc.	Ø16

Type: EK15



Eurocone (3/4" F) for copper tube 15mm
Racor Eurocono niquelado
Acessório Eurocone niquelado

Article number	Bag / Box	Type
EK15	25 pc. / 400 pc.	Ø15

Type: SPLIT-S



Split ring for compression fittings (not for EK)
Anillo partido para racores de compresión (no para EK)
Anel bipartido para acessórios de compressão (não para EK)

Article number	Bag	Type
SPLIT-S16	10 pc.	Ø16
SPLIT-S20	10 pc.	Ø20

Type: AB



Elbow 90° eurocone elbow (3/4" M)
Codo 90° Eurocono (3/4" M)
Joelho Eurocone de 90° (3/4 "M)

Article number	Bag / Box	Type
AB1420	10 pc. / 100 pc.	3/4"x3/4" for EK



Type: ABE



Elbow 90° eurocone (3/4" M) x 1/2" male adapter
 Codo 90° Eurocono (3/4" M) x rosca macho 1/2"
 Joelho Eurocone de 90° (3/4" M) x 1/2" rosca macho

Article number	Bag / Box	Type
ABEK04	10 pc. / 150 pc.	1/2"x3/4"

Type: AT



Eurocone equal T
 Te igual eurocono
 Adaptador Eurocone (3/4" M) a 1/2" rosca macho

Article number	Bag / Box	Type
AT1420	10 pc. / 100 pc.	3/4"x3/4"x3/4"

Type: AD



Eurocone straight coupling (3/4" M)
 Manguito unión Eurocono (3/4" M)
 União Eurocone (3/4" M)

Article number	Bag / Box	Type
AD-EKEK	10 pc. / 250 pc.	3/4"x3/4" for

Type: AN



Straight eurocone connection (3/4" M) to 1/2" male adapter
 Racor adaptador Eurocono (3/4" M) a rosca macho 1/2"
 Adaptador Eurocone (3/4" M) a 1/2" rosca macho

Article number	Bag / Box	Type
AN1420	10 pc. / 250 pc.	1/2"x3/4" for

- 1
- 2
- 3
- 4
- 5
- 6
- 7
- 8
- 9
- 10
- 11
- 12



1 **Type: 3EK**



Double backplate elbow female, 2x eurocone connection
Codo doble placa hembra, 2x conexión eurocono
Dupla placa fêmea de Joelho, 2x ligação Eurocone

Article number	Bag / Box	Type
3EK-050405	5 pc. / 40 pc.	3/4"x1/2"x3/4" (50 mm)

2
3
4
5
6
7 **Type: WALL BOX**

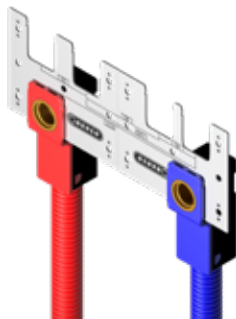

Wall box COMPRESSION
Caja de pared
Caixa de parede 2 par vermelho/azul 1/2 "F x16 mm

Article number	Box / Big box	Type.
WBS-1604-RO	10 pc. / 300 pc.	16x1/2"
WBS-1604-BL	10 pc. / 300 pc.	16x1/2"

without mounting bracket



Instruction video

8
9
10
11
12 **Type: WB-PLATE**

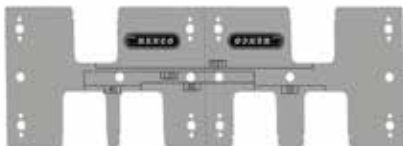

Wall Box mounting bracket
SopORTE de montaje Wall Box
Suporte de montagem de caixa de parede em

Article number	Bag / Box	Type
WBPL-X	10 pc. / 60 pc.	

Type: 2C



Wall plate horizontal
Placa pared horizontal 1/2 "x1 / 2"
Placa de parede horizontal 1/2 "x1 / 2"

Article number	Bag / Box	Type
2C-0404	10 pc. / 100 pc.	1/2"x1/2"



	<i>Page</i>
A. FULL FLOW MANIFOLD	96
B. BRASS	101



A. FULL FLOW MANIFOLD

Type: VSKEK-0502

2-group basic part with 2 eurocone connections 3/4"

Prolongador colector 2 salidas

Prolongador coletor 2 saidas



Article number	Bag / Box	Type
VSKEK-0502	10 pc. / 30 pc.	2x3/4"

Type: VSKEK-0503

3-group basic part with 3 eurocone connections 3/4"

Prolongador colector 3 salidas

Prolongador coletor 3 saidas



Article number	Bag / Box	Type
VSKEK-0503	10 pc. / 30 pc.	3x3/4"

Type: 19SK

Push fitting with eurocone connection

Racor pushfit con eurocono

Encaixe pushfit com Eurocone



Article number	Bag / Box	Type
19SK-1505	10 pc. / 80 pc.	15x3/4"
19SK-1605	10 pc. / 80 pc.	16x3/4"
19SK-2005	10 pc. / 80 pc.	20x3/4"

Type: 26SK

Push fitting with swivel and flat sealing

Racor con rótula y junta plana

Encaixe de empurrar com vedação giratória e plana



Article number	Bag / Box	Type
26SK-1605	10 pc. / 80 pc.	16x3/4"
26SK-2005	10 pc. / 80 pc.	20x3/4"

Type: VVSK

Straight entry piece

Pieza de entrada recta

Peça de entrada reta



Article number	Bag / Box	Type
VVSK-20	10 pc. / 80 pc.	20
VVSK-26	10 pc. / 80 pc.	26

A. FULL FLOW MANIFOLD



Type: VVSK-TM



T-piece for supply for manifold
Te pushfit para alimentación VVSK
Tê para o coletor Vision

Article number	Bag / Box	Type
VVSK-T20M20	10 pc. / 30 pc.	20-20
VVSK-T26M26	5 pc. / 20 pc.	26-26

Type: 17SKS



Straight nipple male (brass)
Racor recto macho
Encaixe macho

Article number	Bag / Box	Type
17SKS-2004	5 pc. / 150 pc.	20 x 1/2"
17SKS-2005	5 pc. / 150 pc.	20 x 3/4"
17SKS-2604	5 pc. / 100 pc.	26 x 1/2"
17SKS-2605	5 pc. / 100 pc.	26 x 3/4"

Applicable with HENCO Vision fittings & manifolds

Type: 18SKS



Straight nipple female (brass)
Racor recto hembra
Encaixe fêmea

Article number	Bag / Box	Type
18SKS-2004	5 pc. / 150 pc.	20 x 1/2"
18SKS-2005	5 pc. / 100 pc.	20 x 3/4"
18SKS-2604	5 pc. / 100 pc.	26 x 1/2"
18SKS-2605	5 pc. / 80 pc.	26 x 3/4"

Applicable with HENCO Vision fittings & manifolds

Type: VVSK-90



Elbow 90° push fitting for supply VVSK
Codo 90° para coletor
Joelho 90° para coletor

Article number	Bag / Box	Type
VVSK-20-90	10 pc. / 70 pc.	20-90
VVSK-26-90	10 pc. / 50 pc.	26-90



A. FULL FLOW MANIFOLD

1

Type: VVSK-T

2

3

4

5

6



T-piece push fitting for supply VVSK
 Racor T pushfit para alimentación VVSK
 Encaixe T pushfit para fornecimento VVSK

Article number	Bag / Box	Type
VVSK-T202020	10 pc. / 40 pc.	20-20-20
VVSK-T262626	10 pc. / 20 pc.	26-26-26

7

Type: VS-ENDCAP

8

9

10

11

12



Endcap female for manifold
 Tapon final Hembra para colector
 Tampão final fêmea para coletor

Article number	Bag / Box	Type
VS-ENDCAP	10 pc. / 180 pc.	F

Type: 18EK05-03



3/4" eurocone connection x 3/8" brass female thread
 Conexión para colector de visión 3/8 "
 Conexão para coletor de visão 3/8 "

Article number	Bag / Box	Type
18EK05-03	2 st. / 200 st.	EKx3/8"

Type: VDEK-T05



T-piece connection 2x eurocone 3/4" to male thread of manifold
 Pieza de conexión en T - 2x eurocone
 Acessório em TÊ para coletor

Article number	Bag / Box	Type
VDEK-T05	10 st. / 50 st.	

Type: VS-ENDCAP-M



End plug male for manifold
 Tapón final macho para colector
 Tampão fêmea en port coletor

Article number	Bag / Box	Type
VS-ENDCAP-M	10 pc. / 150 pc.	M

A. FULL FLOW MANIFOLD



Type: ENDCAP-EK05



Eurocone endcap 3/4" white
Tapón Eurocono 3/4" blanco
Tampao Eurocone 3/4" branco

Article number	Bag / Box	Type
ENDCAP-EK05	10 pc. / 200 pc.	3/4"

Type: VDSK



Through-connector for mounting on male thread distributor
Racor macho rosca colector
Acessório rosca macho para colector

Article number	Bag / Box	Type
VDSK-20	10 pc. / 80 pc.	20
VDSK-26	10 pc. / 60 pc.	26

Type: SK-STOPCLIP



Reusable stop and clip for push fit connection
Tapón para racor pushfit
Tampão para acessórios Pushfit

Article number	Bag / Box	Type
SK-STOPCLIP16	10 pc. / 120 pc.	16
SK-STOPCLIP20	10 pc. / 100 pc.	20
SK-STOPCLIP26	10 pc. / 80 pc.	26

Type: SK-B05



Bracket for Vision manifolds
Soporte para colectores
Suporte para coletores

Article number	Bag / Box	Typ
SK-B05	1 pc. / 200 pc.	B05

Type: VVPK



Straight entry piece - press
Racor recto entrada prensado
Peça de entrada reta - Pressione

Article number	Bag / Box	Typ
VVPK-20	10 pc. / 80 pc.	20
VVPK-26	10 pc. / 70 pc.	26

1

2

3

4

5

6

7

8

9

10

11

12



A. FULL FLOW MANIFOLD

Type: VVPK90-D



Bend entry piece down 90° - press
 Codo 90° entrada inferior prensado
 Joelho press a 90° para coletor

Article number	Bag / Box	Type
VVPK90-20-D	10 pc. / 70 pc.	20-90
VVPK90-26-D	10 pc. / 50 pc.	26-90

Type: VVPK90-U



Bend entry piece up 90° - press
 Codo 90° entrada superior prensado
 Joelho press a 90° port coletor

Article number	Bag / Box	Type
VVPK90-20-U	10 pc. / 70 pc.	20-90
VVPK90-26-U	10 pc. / 50 pc.	26-90

MANY POSSIBLE COMBINATIONS / VARIAS COMBINACIONES POSIBLES / VÁRIAS COMBINAÇÕES POSSÍVEIS

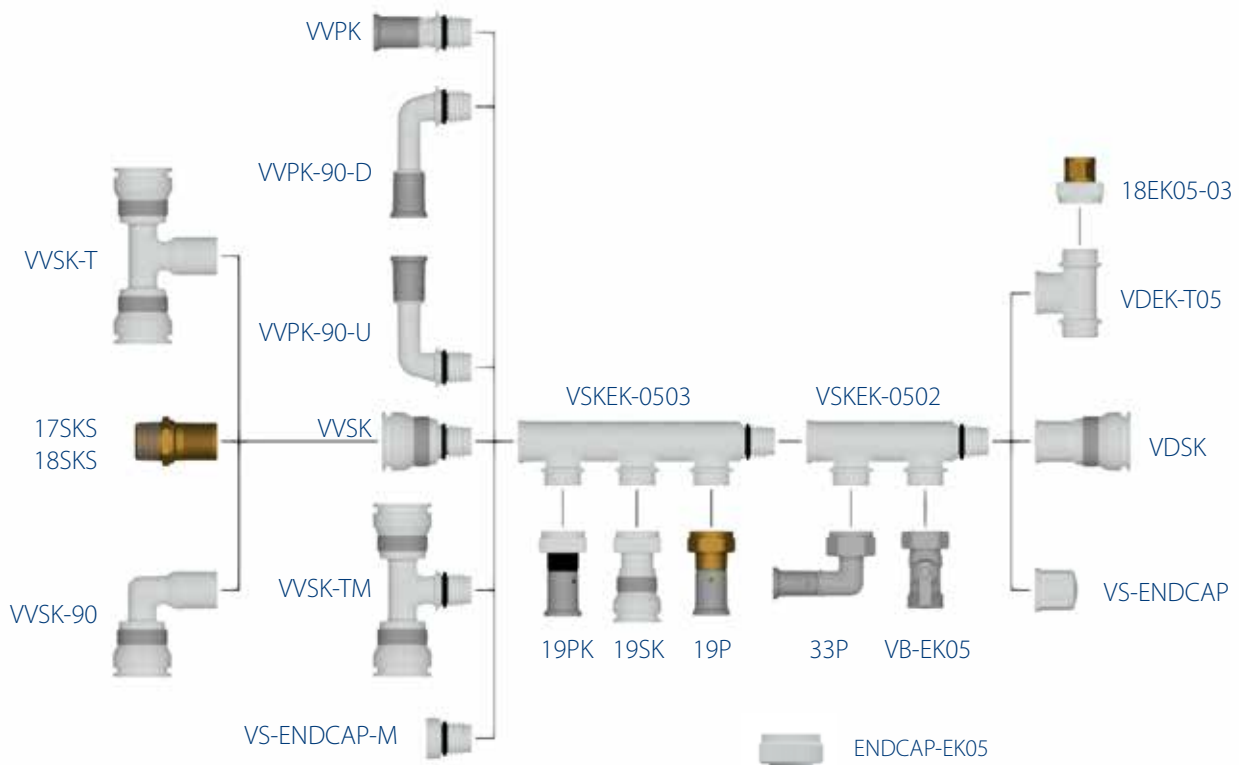



Type: V-06

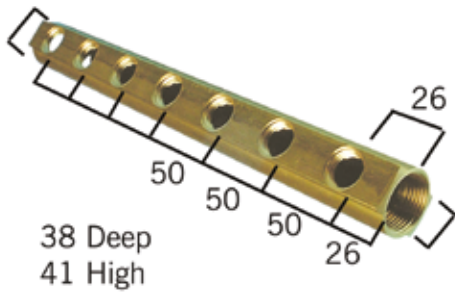

Manifold 1", 1/2" female thread, 3/8" air vent hole
 Colector 1" con salidas rosca hembra de 1/2" y una salida para purgador 3/8"
 Coletor 1" com saídas roscadas fêmeas de 1/2" com purgador 3/8"

Article number	Bag / Box	Type
V-060402	1 pc. / 64 pc.	1" 2x1/2" x 3/8"
V-060404	1 pc. / 30 pc.	1" 4x1/2" x 3/8"
V-060405	1 pc. / 28 pc.	1" 5x1/2" x 3/8"
V-060406	1 pc. / 20 pc.	1" 6x1/2" x 3/8"
V-060408	1 pc. / 20 pc.	1" 8x1/2" x 3/8"

Type: V-05-Z

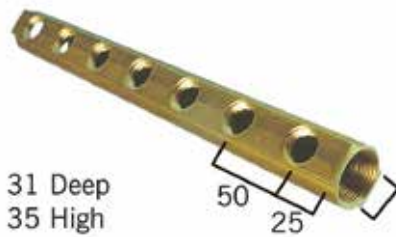

Manifold 3/4", 1/2" female thread
 Colector 3/4" con salidas rosca hembra de 1/2" sin salida para purgador
 Coletor 3/4" com saídas de rosca fêmea de 1/2" sem purgador

Article number	Bag / Box	Type
V-050404-Z	1 pc. / 30 pc.	3/4" 4x1/2"

Type: VEK-06



Manifold 1" with connections and one 3/8" air vent hole
 Colector de 1" con conexiones y un orificio de ventilación de 3/8"
 Manifold 1" com ligações e um orifício de ventilação de 3/8"

Article number	Bag / Box	Type
VEK-060502	1 pc. / 48 pc.	1" 2x3/4" x 3/8"
VEK-060503	1 pc. / 32 pc.	1" 3x3/4" x 3/8"
VEK-060504	1 pc. / 20 pc.	1" 4x3/4" x 3/8"
VEK-060505	1 pc. / 21 pc.	1" 5x3/4" x 3/8"
VEK-060507	1 pc. / 20 pc.	1" 7x3/4" x 3/8"
VEK-060508	1 pc. / 20 pc.	1" 8x3/4" x 3/8"

Type: VEK-06-Z

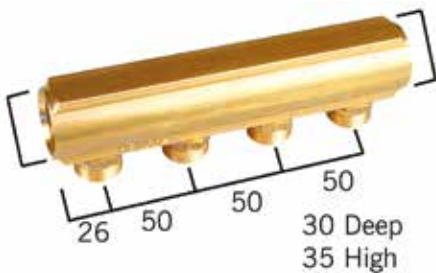

Manifold 1" with eurocone connections
 Colector 1" eurocono purgador 3/8"
 Coletor 1" Eurocone com purgador 3/8"

Article number	Bag / Box	Type
VEK-060503-Z	1 pc. / 32 pc.	1" 3x3/4"
VEK-060504-Z	1 pc. / 20 pc.	1" 4x3/4"
VEK-060505-Z	1 pc. / 21 pc.	1" 5x3/4"
VEK-060506-Z	1 pc. / 20 pc.	1" 6x3/4"
VEK-060507-Z	1 pc. / 20 pc.	1" 7x3/4"
VEK-060508-Z	1 pc. / 20 pc.	1" 8x3/4"
VEK-060509-Z	1 pc. / 15 pc.	1" 9x3/4"
VEK-060510-Z	1 pc. / 15 pc.	1" 10x3/4"



B. BRASS

1 Type: H-0212

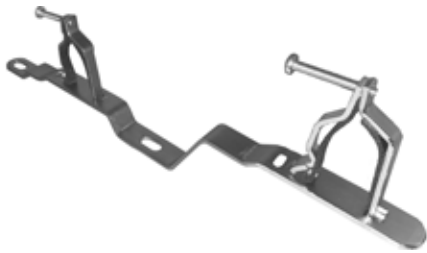

Manifold bracket, double, with rubber lining, for all manifolds)
 Soporte de colector, doble, con revestimiento de goma, para todos los colectores)
 Suporte de colector, duplo, com revestimento de borracha, para todos os colectores)

Article number	Bag / Box	Type
H-0212	2 pc. / 25 x 2 pc.	3/4" - 1

6 Type: H-0212-S



Manifold bracket, with rubber lining, for all manifolds)
 Soporte de colector, con revestimiento de goma, para todos los colectores
 Suporte de colectores, com revestimento de borracha, para todos os colectores)

Article number	Bag / Box	Type
H-0212-S	1 pc. / 500 pc.	3/4" - 1"

11 Type: VS REDUCTIE



Manifold reducer with O-ring
 Reducción para colector
 Redução para coletor

Article number	Bag / Box	Type
VS-0504	10 pc. / 500 pc.	3/4"x1/2"
VS-0604	10 pc. / 250 pc.	1"x1/2"
VS-0605	10 pc. / 250 pc.	1"x3/4"

Type: VS BLINDSTOP



Manifold plug with O-ring
 Tapón múltiple con junta tórica
 Tampão múltiplo com junta tórica

Article number	Bag / Box	Type
VS-05	10 pc. / 250 pc.	3/4"
VS-06	10 pc. / 200 pc.	1"
VS-07	10 pc. / 200 pc.	5/4"

Type: VB-EK05



Ball valve, 2 x eurocone connection
 Válvula esfera, 2 x conexión Eurocono
 válvula de esfera, 2 x ligação Eurocone

Article number	Box / Big Box	Type
VB-EK05	25 pc. / 200 pc.	3/4" EK x 3/4" EK

Type: VB-HANDLE



Handle for VB-EK05 ball valve and VB05 and VB06 manifolds
 Mango para la válvula de bola VB-EK05 y los colectores VB05 y VB06
 Pega para válvula de esfera VB-EK05 e colectores VB05 e VB06

Article number	Box / Big Box	Type
VB-HANDLE-RED	1 pc. / 100 pc.	Red/Rood/Rouge/Rot
VB-HANDLE-BLUE	1 pc. / 100 pc.	Blue/Blauw/Bleu/Blau



Type: VB05



Manifold 3/4" with ball valves and eurocone connection

Colector 3/4" con válvulas esfera y salidas Eurocono

Coletor 3/4" com válvulas de esfera e saídas Eurocone

Article number	Bag / Box	Type
VB050502-BLAUW	5 pc. / 50 pc.	3/4"x2xEK14,16,18 & 20
VB050502-ROOD	5 pc. / 50 pc.	3/4"x2xEK14,16,18 & 20
VB050503-BLAUW	5 pc. / 50 pc.	3/4"x3xEK14,16,18 & 20
VB050503-ROOD	5 pc. / 50 pc.	3/4"x3xEK14,16,18 & 20
VB050504-BLAUW	4 pc. / 40 pc.	3/4"x4xEK14,16,18 & 20
VB050504-ROOD	4 pc. / 40 pc.	3/4"x4xEK14,16,18 & 20

Type: VB06



Manifold 1" with ball valves and eurocone connection

Colector 1" con válvulas esfera y salidas Eurocono

Coletor 1" com válvulas de esfera e saídas Eurocone

Article number	Bag / Box	Type
VB060502-BLAUW	5 pc. / 50 pc.	1"x2xEK14,16,18 & 20
VB060502-ROOD	5 pc. / 50 pc.	1"x2xEK14,16,18 & 20
VB060503-BLAUW	5 pc. / 40 pc.	1"x3xEK14,16,18 & 20
VB060503-ROOD	5 pc. / 40 pc.	1"x3xEK14,16,18 & 20
VB060504-BLAUW	4 pc. / 40 pc.	1"x4xEK14,16,18 & 20
VB060504-ROOD	4 pc. / 40 pc.	1"x4xEK14,16,18 & 20

Type: VBS05



Manifold 3/4" with valves and eurocone connection

Colector 3/4" con válvula cierre

Coletor 3/4" com válvula de corte

Article number	Bag / Box	Type
VBS050502-BL	1 pc. / 20 pc.	3/4"x2xEK14,16,18 & 20
VBS050502-RO	1 pc. / 20 pc.	3/4"x2xEK14,16,18 & 20
VBS050503-BL	1 pc. / 15 pc.	3/4"x3xEK14,16,18 & 20
VBS050503-RO	1 pc. / 15 pc.	3/4"x3xEK14,16,18 & 20
VBS050504-BL	1 pc. / 10 pc.	3/4"x4xEK14,16,18 & 20
VBS050504-RO	1 pc. / 10 pc.	3/4"x4xEK14,16,18 & 20

Type: VBS06



Manifold 1" with valves and eurocone connection

Colector 1" con válvula cierre

Coletor 1" com válvula de corte

Article number	Bag / Box	Type
VBS060502-BL	1 pc. / 20 pc.	1"x2xEK14,16,18 & 20
VBS060502-RO	1 pc. / 20 pc.	1"x2xEK14,16,18 & 20
VBS060503-BL	1 pc. / 15 pc.	1"x3xEK14,16,18 & 20
VBS060503-RO	1 pc. / 15 pc.	1"x3xEK14,16,18 & 20
VBS060504-BL	1 pc. / 10 pc.	1"x4xEK14,16,18 & 20
VBS060504-RO	1 pc. / 10 pc.	1"x4xEK14,16,18 & 20



B. BRASS

1 Type: VBS



Plug M with O-ring VBS Manifold
 Tapón M con colector VBS de junta tórica
 Plug M com O-ring VBS Manifold

Article number	Bag / Box	Type	
VBS-05	10 pc. / 250 pc.	3/4"	male
VBS-06	10 pc. / 250 pc.	1"	male

6 Type: VBS-F



Manifold plug F for VBS manifold
 Tapón del bloque F con junta tórica para bloque VBS
 Bujão do manifold F com O-ring para manifold VBS

Article number	Bag / Box	Type	
VBS-05F	10 pc. / 250 pc.	3/4"	female
VBS-06F	10 pc. / 250 pc.	1"	female

12 Type: 17VBS



Straight adapter VBS manifold
 Racor fijo recto colector
 Coletor de encaixe fixo

Article number	Bag / Box	Type
17VBS-2005	10 pc. / 150 pc.	20mmx3/4"
17VBS-2605	5 pc. / 80 pc.	26mmx3/4"
17VBS-2606	5 pc. / 80 pc.	26mmx1"

Type: 6VBS



Bend 90° VBS manifold
 Adaptador de hierro hembra curva de 90 ° para colector VBS
 Curva adaptador de ferro 90° fêmea para colector VBS

Article number	Bag / Box	Type
6VBS-2005	10 pc. / 50 pc.	20mmx3/4"
6VBS-2605	5 pc. / 50 pc.	26mmx3/4"

Type: SK-B05



Bracket for Full Flow Manifold and VBS manifolds
 Soporte para colectores de flujo total y colectores VBS
 Suporte para colectores de fluxo total e colectores VBS

Article number	Bag / Box	Typ
SK-B05	1 pc. / 200 pc.	B05





1

Type: RAD04-100V**Radiator connector with 3/4" eurocone connections, straight****Conexión radiador, recta, bitubo, 3/4" Eurocono****Ligação do radiador, recta, bitubo, 3/4" Eurocono**

Article number	Box / Big Box	Type
RAD04-100V	10 pc. / 100 pc.	1/2"x3/4" EK

TILL EXHAUSTION OF STOCK

2

3

4

5

6

7

Type: EK15**Eurocone (3/4"F) for copper tube 15mm****Racor eurocono niquelado****Acessório Eurocono niquelado**

Article number	Box / Big Box	Type
EK15	25 pc. / 400 pc.	Ø15

8

9

10

11

12

Type: RADTH-VL**Thermostatic radiator valve head****Cabeza termostática radiador****Cabeça termostática**

Article number	Box / Big Box	Type
RADTH-VL	10 pc. / 150 pc.	THERM

TILL EXHAUSTION OF STOCK



Type: BAP-FFV (press x press)*



Stainless steel Full Flow Valve - press x press connections
Válvula de flujo total de acero inoxidable - conexiones prensa x prensa
Válvula de fluxo total em aço inoxidável - prensa x conexões de prensa

Article number	Box / Big Box	Type
BAP-FFV1616	25 pc.	16 x 16
BAP-FFV2020	25 pc.	20 x 20
BAP-FFV2626	25 pc.	26 x 26
BAP-FFV3232	15 pc.	32 x 32

Type: BAP-FFV (press x female thread)*



Stainless steel Full Flow Valve - press x female thread connections
Válvula de flujo total de acero inoxidable - conexiones prensa x rosca hembra
Stainless steel Full Flow Valve - press x female thread connections

Article number	Box / Big Box	Type
BAP-FFV1604	25 pc.	16 x 1/2"
BAP-FFV1805	25 pc.	18 x 3/4"
BAP-FFV2005	25 pc.	20 x 3/4"
BAP-FFV2605	25 pc.	26 x 3/4"
BAP-FFV2606	15 pc.	26 x 1"
BAP-FFV3207	15 pc.	32 x 1 1/4"

Type: BAP-FFV (press x swivel)*



Stainless steel Full Flow Valve - press x swivel connections
Válvula de flujo total de acero inoxidable - conexiones a presión x giratorias
Válvula de fluxo total de aço inoxidável - conexões a pressão x giratorias

Article number	Box / Big Box	Type
BAP-FFV16Z05	25 pc.	16 x 3/4"
BAP-FFV20Z05	25 pc.	20 x 3/4"
BAP-FFV26Z05	25 pc.	26 x 3/4"
BAP-FFV26Z06	15 pc.	26 x 1"
BAP-FFV32Z06	15 pc.	32 x 1"

Type: BAP-FFV (press x eurocone)*



Stainless steel Full Flow Valve - press x eurocone connections
Válvula de flujo total de acero inoxidable - conexiones de prensa x eurocono
Válvula de fluxo total em aço inoxidável - prensa x ligações eurocone

Article number	Box / Big Box	Type
BAP-FFV1605EK	25 pc.	16 x 3/4"
BAP-FFV2005EK	25 pc.	20 x 3/4"
BAP-FFV2605EK	15 pc.	26 x 3/4"



1 **Type: RADNI**



Nipple for H radiator block
Racor para conexión radiador
Adaptação para ligação de radiadores

Article number	Bag / Box	Type
RADNI-0504	10 pc. / 500 pc.	1/2"x3/4"

6 **Type: BAP-H**



Ball valve with handle, 2 x pressfitting
Válvula esfera, palanca, 2x accesorios a presión
Válvula de esfera, alavanca press

Article number	Box / Big Box	Type
BAP-H1616	8 pc. / 80 pc.	16x16
BAP-H2020	8 pc. / 80 pc.	20x20
BAP-H2626	8 pc. / 80 pc.	26x26
BAP-H3232	5 pc. / 25 pc.	32x32

12 **Type: BAP-SV**



Stopvalve DN10
Válvula de corte DN10
Válvula de corte DN10

Article number	Box / Big Box	Type
BAP-SV1610S	10 pc. / 100 pc.	16 x 10



Type: 41S



Brass Vision coupling with valve F-connection
Acoplamiento Vision de latón con válvula de conexión F
Acoplamento Brass Vision com válvula F-conexão

Article number	Bag / Box	Typ
41S-20	10 pc. / 60 pc.	20
41S-26	10 pc. / 80 pc.	26

Type: 41SKS



Connection Vision coupling with valve F-connection
Conexión Acoplamiento Vision con válvula Conexión F
Ligação Ligação Vision acoplamento com válvula F-conexão

Article number	Bag / Box	Typ
41SKS-20	10 pc. / 80 pc.	20
41SKS-26	10 pc. / 80 pc.	26

Type: BA-F



Built in ball valve Fastec DN15
Válvula esfera integrada Fastec DN15
Válvula de esfera integrada Fastec DN15

Article number	Box / Big Box	Type
BA-F41	1 pc. / 50 pc.	



- 1
- 2
- 3
- 4
- 5
- 6
- 7
- 8
- 9
- 10
- 11
- 12

UNDERFLOOR HEATING - CALEFACCIÓN POR SUELO RADIANTE PISO RADIANTE

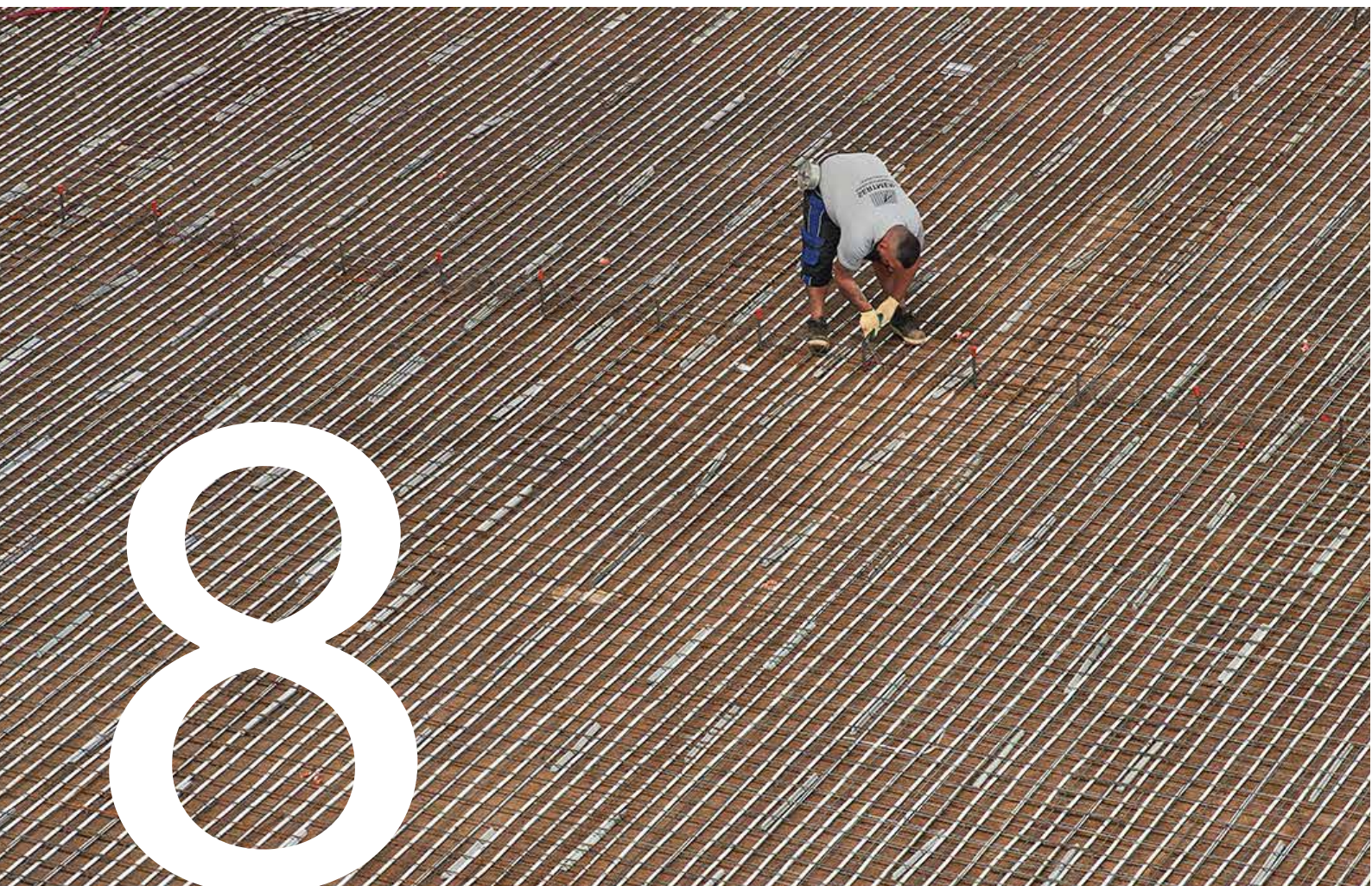

	<i>Page</i>
A. SYSTEMS	111
B. MANIFOLDS	119
C. CONTROL UNITS	127



Type: UFH-ISOPRO30



System plate with 30 mm EPS insulation and 28dB acoustic improvement
 Placa del sistema con aislamiento EPS de 30 mm y mejora acústica de 28dB
 Placa de sistema com isolamento EPS de 30 mm e melhoria acústica de 28dB

Article number	Packing	Type
UFH-ISOPRO30 *	6,72m ² (6 x 1,12m ²)	1400x800mm - 5kPa - 28dB

* Pipe Ø16, centre-to-centre: multiple 50mm hor./ver.

Type: UFH-ISOPRO11



System plate with 11 mm EPS insulation
 Placa del sistema con aislamiento EPS de 11 mm
 Placa do sistema com isolamento EPS de 11 mm

Article number	Packing	Type
UFH-ISOPRO11 *	14,56m ² (13 x 1,12m ²)	1400x800mm - 75kPa

* Pipe Ø16, centre-to-centre: multiple 50mm hor./ver.

Type: UFH-PRO



System plate without insulation
 Placa del sistema sin aislamiento
 Placa sem isolamento

Article number	Packing	Type
UFH-PRO *	13,44m ² (12 x 1,12m ²)	1400x800mm - 5kPa

* Pipe Ø16, centre-to-centre: multiple 50mm hor./ver.

Type: UFH-RAS10

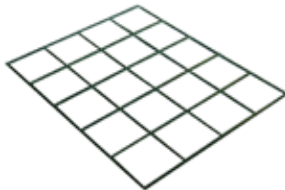

Galvanized steel mesh, 100 x 100 mm, 3 mm
 Malla de acero galvanizado, 100 x 100 mm, 3 mm
 Malha de aço galvanizado, 100 x 100 mm, 3 mm

Article number	Packing	Type
UFH-RAS10	10 pc.	2,52 m ² - grid 100x100mm

Type: UFH-RAS15

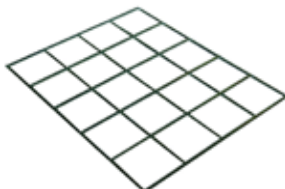

Galvanized steel mesh, 150 x 150 mm, 3 mm
 Malla de acero galvanizado, 150 x 150 mm, 3 mm
 Malha de aço galvanizado, 150 x 150 mm, 3 mm

Article number	Packing	Type
UFH-RAS15	10 pc.	2,52 m ² - grid 150x150mm

Type: UFH-RAS20

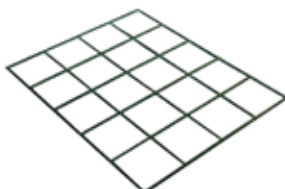

Galvanized steel mesh, 200 x 200 mm, 3 mm
 Malla de acero galvanizado, 200 x 200 mm, 3 mm
 Malha de aço galvanizado, 200 x 200 mm, 3 mm

Article number	Packing	Type
UFH-RAS20	10 pc.	2,4 m ² - grid 200x200mm



A. SYSTEMS

1 Type: UFH-RAS-RB3



Connection clip for steel mesh
Clip de conexión para malla de acero
Clips de ligação para malha de aço

Article number	Packing	Type
UFH-RAS-RB3	30 pc.	RB

6 Type: UFH-RAS-BIND15



UFH-RAS-VLE p 156

Steel strand, plasticized, to connect pipe on steel mesh
Amarra de alambre de acero, plastificado, para conectar tubo con malla de acero
Fixação de arame de aço, plastificado, para ligação de tubos com rede de arame de aço

Article number	Packing	Type
UFH-RAS-BIND15A	250 pc.	160 mm
UFH-RAS-BIND15B	2500 pc.	160 mm

12 Type: UFH-RAS-CLIP



Synthetic clip for steel mesh
Clip sintético para malla de acero
Clip sintético para malha de aço

Article number	Packing	Type
UFH-RAS-CLIP16	200 pc.	Ø16
UFH-RAS-CLIP18	200 pc.	Ø18
UFH-RAS-CLIP20	200 pc.	Ø20

Type: UFH-TACK-KLS

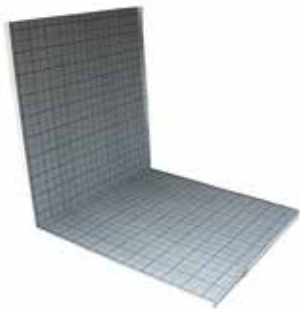

Tacker sheet with EPS insulation, foil with 100 x 100 mm grid marking and overlap
Lámina de tachuelas con aislamiento de EPS, lámina con marca de rejilla de 100 x 100 mm y solapamiento
Folha de Cavaco com isolamento EPS, folha de alumínio com marcação em grelha de 100 x 100 mm e sobreposição

Article number	Packing	Type
UFH-TACK-KLS20	10 m ² (5 x 2 m ²)	1000x2000x20mm - 4kPa - 28dB
UFH-TACK-KLS25	10 m ² (5 x 2 m ²)	1000x2000x25mm - 4kPa - 28dB
UFH-TACK-KLS30	10 m ² (5 x 2 m ²)	1000x2000x30mm - 4kPa - 29dB

Type: UFH-TACK-38K



UFH-TACK p 156

Tacker clip, 38 mm
Clip grapa, 38 mm
Clip agrafador, 38 mm

Article number	Box / Big Box	Type
UFH-TACK-38K *	300 pc. / 6000 pc.	38 mm

* Pipe Ø 16



Type: UFH-TACK-40



UFH-TACK p 156

Tacker clip, 40 mm
Clip grapa, 40 mm
Clip agrafador, 40 mm

Article number	Box / Big Box	Type
UFH-TACK-40 *	300 pc. / 8.400 pc.	40 mm

* Pipe Ø 16-20

Type: UFH-TACK-60



UFH-TACK p 156

Tacker clip, 60 mm
Clip grapa, 60 mm
Clip agrafador, 60 mm

Article number	Box / Big Box	Type
UFH-TACK-60 *	300 pc. / 6.000 pc.	60 mm

* Pipe Ø 16-20

Type: UFH-SCOTCH-66



Adhesive tape
Cinta adhesiva
Fita adesiva

Article number	Packing	Type
UFH-SCOTCH-66	1 pc.	66 m

Type: UFH-SECOR

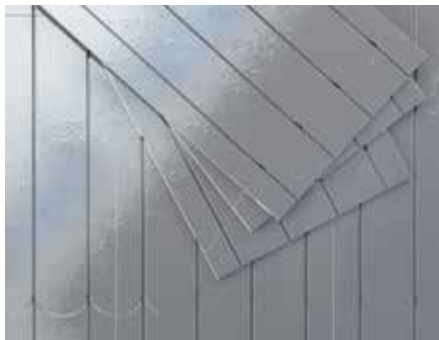

Secor EPS panel with milling and alu foil
Panel Secor EPS con fresado y lámina de aluminio
Painel Secor EPS com fresagem e folha de alumínio

Article number	Packing	Type
UFH-DRY-1617-150F	8,80 m ²	1175 x 750 x 17 - 150mm
UFH-DRY-1617-200F	9,00 m ²	1175 x 800 x 17 - 200mm
UFH-DRY-1625-100F	9,40 m ²	1175 x 800 x 25 - 100mm
UFH-DRY-1625-150F	8,80 m ²	1175 x 750 x 25 - 150mm
UFH-DRY-1625-200F	9,00 m ²	1175 x 800 x 25 - 200mm
UFH-DRY-1630-150F	9,40 m ²	1175 x 750 x 30 - 150mm

Type: UFH-DRY-TAPE



Alu tape
Cinta de aluminio
Fita Alu

Article number	Packing	Type
UFH-DRY-FTAPE	1 pc.	25000 x 50mm



A. SYSTEMS

Type: UFH-DRY-GLUEF



Secor glue
Cola Secor
Cola Secor

Article number	Packing	Type
UFH-DRY-GLUEF	1 kg	

Type: UFH-P18-GP18



Gypsum fibreboard 18mm, round milling for RENO12 system
Panel de yeso 18 mm, fresado redondo para sistema RENO12
Placa de fibra de gesso 18mm, fresamento redondo para sistema RENO12

Article number	pc	Type
UFH-P18-GP18	1 pc.	1000 x 600 x 18mm

Type: UFH-P18-GP18V



Gypsum fibreboard 18mm, vertical milling for RENO12 system
Panel de yeso 18 mm, fresado vertical para sistema RENO12
Placa de fibra de gesso de 18 mm, fresamento vertical para sistema RENO12

Article number	pc	Type
UFH-P18-GP18V	1 pc.	1000 x 600 x 18mm

Type: UFH-P18-GP10



Gypsum fibreboard 10mm, flat for RENO12 system
Panel de fibra de yeso de 10 mm, plano para sistema RENO12
Placa de fibra de gesso 10mm, plana para sistema RENO12

Article number	pc	Type
UFH-P18-GP10	1 pc.	1500 x 1000 x 10mm

TILL EXHAUSTION OF STOCK

Type: UFH-P18-WN



Mesh for RENO12 system
Malla para sistema RENO12
Malha para sistema RENO12

Article number	Packing	Type
UFH-P18-WN	50 m ²	1 x 50m

TILL EXHAUSTION OF STOCK



Type: UFH-ISODRY-25



Insulation system board for dry system
Placa aislante para sistema DRY
Placa de isolamento para o sistema DRY

Article number	Packing	Type
UFH-ISODRY-25	10 m ²	1000x500x25mm

Type: UFH-DRY-GP100-2



Heat diffusion profile for dry system
Perfil de difusión de calor para sistema DRY
Perfil de difusão de calor para o sistema DRY

Article number	Packing	Type
UFH-DRY-GP100-2	50 pc.	997x120x0,4mm - Ø16

Type: UFH-DRY-VD100

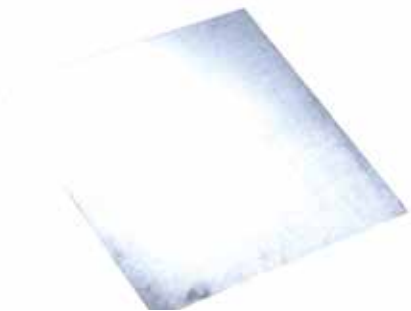

Heat diffusion board for dry system
Placa de difusión de calor para sistema DRY
Placa de difusão de calor para sistema DRY

Article number	Packing	Type
UFH-DRY-VD100	1 pc.	1000x1000mm

Type: UFH-DRY-B



Synthetic mounting bracket for pipe in diagonal position
Soporte sintético para montaje de tubos en posición diagonal
Suporte sintético para instalação de tubos diagonais

Article number	Packing	Type
UFH-DRY-B	100	

Type: UFH-UP-M



Clip rail with adhesive strip, centres 50 mm
Perfil canaleta tubo as 50 x 1000mm
Perfil para tubo 50 x 1000mm

Article number	Box / Pallet	Type
UFH-UP-14M1	100 m / 1000 m	Ø14 - AS 25 mm- 1000 mm
UFH-UP-16M1	100 m / 1000 m	Ø16 - AS 50 mm- 1000 mm

1

2

3

4

5

6

7

8

9

10

11

12



A. SYSTEMS

1 Type: UFH-UP



Clip rail with adhesive strip, centres 50 mm

Canaleta adhesivo cent 50mm

Caneleta adesivo 50mm

Article number	Box / Pallet	Type
UFH-UP-12	32 m / 960 m	Ø12 - AS 25 mm- 2000 mm
UFH-UP-16	100 m / 3000 m	Ø16 - AS 50 mm- 2500 mm

5 Type: UFH-UP-CUP



Staple for clip rail

Grapa para perfil

Clip de perfil

Article number	Box / Big Box	Type
UFH-UP-CUP50	500 pc. / 9000 pc.	50 mm

9 Type: UFH-FOIL



PE film, transparant, with blue grid marking 50 x 50 mm

Película PE, transparente, con cuadrícula marcada en azul 50 x 50 mm

Filme PE, transparente, com quadrícula azul 50 x 50 mm

Article number	Packing	Type
UFH-FOIL50	51 m ²	34m x 1,5m - 0,14mm
UFH-FOIL90	90 m ²	60m x 1,5m - 0,14mm

Type: UFH-FOIL-N



PE film, neutral

Película de PE, neutra

Filme PE, neutro

Article number	Packing	Type
UFH-FOIL-N	100 m ²	50 m x 2 m - 0,2 mm

Type: UFH-FOIL-ALU



PE film, reflecting ALU

Película de PE, reflectante de ALU

Filme PE, refletindo ALU

Article number	Packing	Type
UFH-FOIL-ALU	50 m ²	50 m x 1 m - 3,0 mm

Type: UFH-FOIL-CLIP25



Clip for Film

Clip para láminas

Clipe para filme

Article number	Packing	Type
UFH-FOIL-CLIP25	100 pc.	25 mm



Type: UFH-PLUG80



Plug, shaft length 80 mm, Ø8 mm

Tapón, longitud de eje

Tampão, comprimento do eixo

Article number	Packing	Type
UFH-PLUG80	100 pc.	80 mm, Ø8 mm

Type: UFH-ISOBOARD-S



PE edge isolation with lapping strip and adhesive strip

Cinta perimetral

Fita perimetral

Article number	Packing	Type
UFH-ISOBOARD-S	25 m	150 x 8 mm

Type: UFH-ISOBOARD-GVNL



PE edge isolation with lapping strip and adhesive strip for liquid floors

Aislamiento de bordes de con cinta lapeadora y cinta adhesiva para suelos líquidos

Isolamento de borda de com tira de polimento e tira adesiva para pisos líquidos

Article number	Packing	Type
UFH-ISOBOARD-GVNL	50m	100 mm x 8 mm

Type: UFH-ISOBOARD-GV



PE edge isolation with lapping strip and adhesive strip for anhydrite screed

Aislamiento de bordes de PE con cinta lapeadora y cinta adhesiva para solera de anhidrita

Isolamento de borda de PE com tira de polimento e fita adesiva para mesa de anidrita

Article number	Packing	Type
UFH-ISOBOARD-GV	25 m	150 mm x 8 mm



A. SYSTEMS

1

Type: UFH-DP200

2

3

4

5

6

7

Type: UFH-DH40

8

9

10

11

12

Type: UFH-BEND

Type: UFH-ADN10

PE expansion joint with self-adhesive rail
 Junta de expansión PE con riel autoadhesivo
 Junta de expansão PE auto-adesiva



Article number	Packing	Type
UFH-DP200	2 m	2000 mm x 100 mm x 8 mm

Protection sleeve for expansion joint
 Manga corrugada de protección para junta de expansión
 União corrugada de protecção para junta de expansão



Article number	Packing	Type
UFH-DH40	100 pc.	400 mm

Bend guide for pipe
 Curvatubos para tubos
 Curvatubos



Article number	Packing	Type
UFH-BEND1218	1 pc.	Ø 12 - 18 mm
UFH-BEND20	1 pc.	Ø 20 mm

Additive for screed (min. pipe covering 45 mm)
 Aditivo mortero garrafa 10 litros
 Aditivo de argamassa bidão de 10 litros



Article number	Packing	Type
UFH-ADN10	10 L	



Type: UFH-MDK



Manifold composite, adjustable with flow meter, thermometer washer and air vent
 Colector compuesto, ajustable, con caudalímetro, arandela y purgador
 Coletor ajustável, com caudalímetro e purgador

Article number	Packing	Type
UFH-0605MDK02-03L	1 pc.	1" - 2 x 3/4"
UFH-0605MDK03-03L	1 pc.	1" - 3 x 3/4"
UFH-0605MDK04-03L	1 pc.	1" - 4 x 3/4"
UFH-0605MDK05-03L	1 pc.	1" - 5 x 3/4"
UFH-0605MDK06-03L	1 pc.	1" - 6 x 3/4"
UFH-0605MDK07-03L	1 pc.	1" - 7 x 3/4"
UFH-0605MDK08-03L	1 pc.	1" - 8 x 3/4"
UFH-0605MDK09-03L	1 pc.	1" - 9 x 3/4"
UFH-0605MDK10-03L	1 pc.	1" - 10 x 3/4"
UFH-0605MDK11-03L	1 pc.	1" - 11 x 3/4"
UFH-0605MDK12-03L	1 pc.	1" - 12 x 3/4"

Type: UFH-MDK-CON



Composite connector for MDK manifold
 Conector compuesto para colector MDK
 Conector composto para coletor MDK

Article number	Bag / Box	Type
UFH-MDK-CON	1 pc. / 50 pc.	

Type: UFH-CMDK



Flow meter for MDK manifold
 Caudalímetro para colector MDK
 Medidor de fluxo para coletor MDK

Article number	Packing	Type
UFH-CMDK03	1 pc.	0 - 5 l
UFH-CMDK10	1 pc.	0 - 2,5 l

Type: UFH-MDK-AO



Automatic air vent in composite for MDK manifold
 Purgador automático de aire compuesto para colector MDK
 Abertura de ar automática em composto para coletor MDK

Article number	Packing	Type
UFH-MDK-AO	1 pc.	3/8"



B. MANIFOLDS

Type: UFH-MDSS



Stainless steel manifold
 Colector de acero inoxidable
 Coletor de aço inox

Article number	Packing	Type
UFH-0605MDSS02	1 pc.	1" - 2 x 3/4"
UFH-0605MDSS03	1 pc.	1" - 3 x 3/4"
UFH-0605MDSS04	1 pc.	1" - 4 x 3/4"
UFH-0605MDSS05	1 pc.	1" - 5 x 3/4"
UFH-0605MDSS06	1 pc.	1" - 6 x 3/4"
UFH-0605MDSS07	1 pc.	1" - 7 x 3/4"
UFH-0605MDSS08	1 pc.	1" - 8 x 3/4"
UFH-0605MDSS09	1 pc.	1" - 9 x 3/4"
UFH-0605MDSS10	1 pc.	1" - 10 x 3/4"
UFH-0605MDSS11	1 pc.	1" - 11 x 3/4"
UFH-0605MDSS12	1 pc.	1" - 12 x 3/4"
UFH-0605MDSS13	1 pc.	1" - 13 x 3/4"
UFH-0605MDSS14	1 pc.	1" - 14 x 3/4"
UFH-0605MDSS15	1 pc.	1" - 15 x 3/4"

Type: UFH-CMDSS



Flow meter for MDSS manifold
 Caudalímetro para colector MDSS
 Medidor de fluxo para coletor MDSS

Article number	Packing	Type
UFH-CMDSS	1 pc.	0-5 l

Type: UFH-BMH-VN



Ball valve 90° with gasket, nickel plated (MDK and MDSS manifold), no thermometer
 Válvula de bola de 90° con junta, niquelada (para MDK y MDSS), sin termómetro
 Válvula de esfera 90° com junta, niquelado (para MDK e MDSS), sem termômetro

Article number	Packing	Type
UFH-BMH0606-VN	1 set (2 pc.)	1" x 1"

Type: UFH-BMHT-VN



Ball valve 90° with gasket, nickel plated (MDK and MDSS manifold), incl. thermometer
 Válvula de bola de 90° con junta, niquelada (para colector MDK y MDSS), con termómetro
 Válvula de esfera 90° com gaxeta, niquelado (para manifold MDK e MDSS), com termômetro

Article number	Packing	Type
UFH-BMHT0606T-VN	1 set (2 pc.)	1" x 1"

Type: UFH-BM-VN



Ball valve with gasket, nickel plated (for MDK and MDSS manifold)
 Válvula esfera con junta niquelada
 Válvula de esfera com junta niquelada

Article number	Packing	Type
UFH-B0605-VN*	1 set (2 pc.)	3/4" x 1"
UFH-BM0606-VN	1 set (2 pc.)	1" x 1"

*TILL EXHAUSTION OF STOCK



Type: UFH-06-MD



Manifold brass, adjustable, with flow meters

Colector de latón, ajustable

Colector de latão, ajustável

Article number	Packing	Type
UFH-060502-MD	1 pc.	1" M - 2 x 3/4"
UFH-060503-MD	1 pc.	1" M - 3 x 3/4"
UFH-060504-MD	1 pc.	1" M - 4 x 3/4"
UFH-060505-MD	1 pc.	1" M - 5 x 3/4"
UFH-060506-MD	1 pc.	1" M - 6 x 3/4"
UFH-060507-MD	1 pc.	1" M - 7 x 3/4"
UFH-060508-MD	1 pc.	1" M - 8 x 3/4"
UFH-060509-MD	1 pc.	1" M - 9 x 3/4"
UFH-060510-MD	1 pc.	1" M - 10 x 3/4"
UFH-060511-MD	1 pc.	1" M - 11 x 3/4"
UFH-060512-MD	1 pc.	1" M - 12 x 3/4"

Type: UFH-M-D



Flow meter for brass manifold

Caudalímetro UFH-MD

Caudalimetro UFH-MD

Article number	Packing	Type
UFH-M-D	1 pc.	

Type: UFH-PGKTA



Pump unit A label pump with consistent temperature control

Unidad de bomba etiqueta A (alta eficiencia) con control de temperatura constante

Unidade de bomba classe energética A, com controlo constante de temperatura

Article number	Packing	Type
UFH-PGKTA	1 pc.	1" F / 27°C - 42°C

Type: UFH-PGKTA-TH



Thermostatic sensor UFH-PGKTA

Sensor termostático UFH-PGKTA

Sensor termostático UFH-PGKTA

Article number	Packing	Type
UFH-PGKTA-TH	1 pc.	

Type: UFH-GKT



Unit with consistent temperature control without pump

Unidad con control de temperatura constante sin bomba

Unidade de controlo de temperatura constante sem bomba

Article number	Packing	Type
UFH-GKT	1 pc.	1" F / 27°C - 42°C



B. MANIFOLDS

1

Type: UFH-BT-M

2

3

4

5



1" F ball valve with 1" F swivel nut, washer and thermometer
 Válvula esfera 1" f c/tuerca loca, junta, termómetro
 válvula de esfera 1" F com porca louca, junta e termómetro

Article number	Packing	Type
UFH-BTM0606-M	1 set (2 pc.)	1" F x 1" F / 0 - 60 °

6

Type: UFH-B-M

7

8

9

10



1" F ball valve with 1" F swivel nut and washer
 Válvula esfera 1" f con rosca 1-f y junta
 Válvula esfera 1" f con rosca 1-f y junta

Article number	Packing	Type
UFH-B0606-M	1 set (2 pc.)	1" F x 1" F

11

Type: UFH-ESK-M

12



1" F end cap with nut, washer, ball valve and air vent 3/8"
 Tapón final 1" F con tuerca, arandela, válvula de bola y purgador de aire 3/8"
 Verteilerendstückset 1" IG mit Mutter und Dichtung, Enlüftung 3/8", Kugelhahnset, Entleerung 1/2"

Article number	Packing	Type
UFH-ESK060303-M	1 set (2 pc.)	1" F x 1/2" x 3/8"

Type: UFH-ESK-VN



1" F end cap with nut, washer, ball valve and air vent 3/8", nickel-plated
 Tapón con tuerca 1" F, arandela, válvula esfera y purgador 3/8"
 Tampão com porca 1" F, anilha, válvula de esfera e purgador de 3/8"

Article number	Packing	Type
UFH-ESK060303-VN	1 set (2 pc.)	1" F x 1/2" x 3/8"

Type: UFH-AO-MZ



Automatic air vent, without check valve
 Purgador con tuerca, válvula esfera
 Purgador com porca, válvula de esfera

Article number	Packing	Type
UFH-AO03-MZ	1 pc.	3/8"

Type: UFH-TM-M



Thermometer for return with EK connections
 Termómetro de retorno con conexiones EK
 Termómetro para retorno com conexões EK

Article number	Packing	Type
UFH-TM050-M	1 pc.	3/4" - 3/4" EK / 0



Type: UFH-BS-M



End cap with washer
Tapón final con arandela
Parada cega

Article number	Packing	Type
UFH-BS05-M	1 pc.	3/4"

Type: UFH-C260003001



Thermostatic temperature limiter
Limitador de temperatura termostático
Limitador de temperatura termostático

Article number	Packing	Type
UFH-C260003001	1 pc.	3/4"

Type: UFH-B-VN



1" F ball valve with 1" F swivel nut and washer , nickel-plated
Válvula esfera 1" f con rosca 1-f y junta
Válvula de esfera 1 " fêmea

Article number	Packing	Type
UFH-B0606-VN	1 set (2 pc.)	1" F x 1" F / 0 - 60 °

TILL EXHAUSTION OF STOCK



B. MANIFOLDS

Type: UFH-CDP



Also available with Active Flow Control
Including cord, plug and maximum
thermostat

Manifold composite, adjustable with flow meter and A-pump
Colector compuesto, ajustable, con caudalímetro y bomba
Coletor ajustável, com caudalímetro e bomba

Article number	Packing	Type
UFH-0405CDP01	1 pc.	1/2" - 1 x 3/4"
UFH-0405CDP02	1 pc.	1/2" - 2 x 3/4"
UFH-0405CDP03	1 pc.	1/2" - 3 x 3/4"
UFH-0405CDP04	1 pc.	1/2" - 4 x 3/4"
UFH-0405CDP05	1 pc.	1/2" - 5 x 3/4"
UFH-0405CDP06	1 pc.	1/2" - 6 x 3/4"
UFH-0505CDP07	1 pc.	3/4" - 7 x 3/4"
UFH-0505CDP08	1 pc.	3/4" - 8 x 3/4"
UFH-0505CDP09	1 pc.	3/4" - 9 x 3/4"
UFH-0505CDP10	1 pc.	3/4" - 10 x 3/4"
UFH-0505CDP11	1 pc.	3/4" - 11 x 3/4"
UFH-0505CDP12	1 pc.	3/4" - 12 x 3/4"
UFH-0505CDP13	1 pc.	3/4" - 13 x 3/4"
UFH-0505CDP14	1 pc.	3/4" - 14 x 3/4"
UFH-0505CDP15	1 pc.	3/4" - 15 x 3/4"
UFH-0505CDP16	1 pc.	3/4" - 16 x 3/4"

Type: UFH-CD

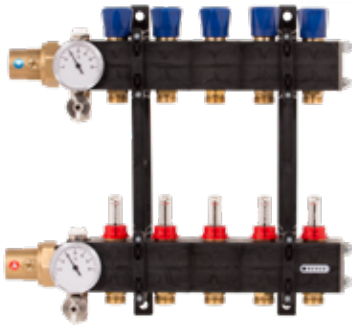

Also available with Active Flow Control

Manifold composite, adjustable with flow meter
Colector compuesto, ajustable, con caudalímetro
Coletor ajustável, com caudalímetro

Article number	Packing	Type
UFH-0605CD01	1 pc.	1" - 1 x 3/4"
UFH-0605CD02	1 pc.	1" - 2 x 3/4"
UFH-0605CD03	1 pc.	1" - 3 x 3/4"
UFH-0605CD04	1 pc.	1" - 4 x 3/4"
UFH-0605CD05	1 pc.	1" - 5 x 3/4"
UFH-0605CD06	1 pc.	1" - 6 x 3/4"
UFH-0605CD07	1 pc.	1" - 7 x 3/4"
UFH-0605CD08	1 pc.	1" - 8 x 3/4"
UFH-0605CD09	1 pc.	1" - 9 x 3/4"
UFH-0605CD10	1 pc.	1" - 10 x 3/4"
UFH-0605CD11	1 pc.	1" - 11 x 3/4"
UFH-0605CD12	1 pc.	1" - 12 x 3/4"
UFH-0605CD13	1 pc.	1" - 13 x 3/4"
UFH-0605CD14	1 pc.	1" - 14 x 3/4"
UFH-0605CD15	1 pc.	1" - 15 x 3/4"
UFH-0605CD16	1 pc.	1" - 16 x 3/4"
UFH-0605CD17	1 pc.	1" - 17 x 3/4"
UFH-0605CD18	1 pc.	1" - 18 x 3/4"
UFH-0605CD19	1 pc.	1" - 19 x 3/4"
UFH-0605CD20	1 pc.	1" - 20 x 3/4"

Type: UFH-CP



A-pump unit for composite collector
Kit bomba para colectores compuesto
Kit de bomba para coletor sintético

Article number	Packing	Type
UFH-CP	1 pc.	1"



Type: UFH-SLT



Including cord, plug and maximum thermostat

Steel collector with A-pump
Colector acero con bomba tipo A
Coletor aço com bomba tipo A

Article number	Packing	Type
UFH-0405SLT01	1 pc.	1/2" - 1 x 3/4"
UFH-0405SLT02	1 pc.	1/2" - 2 x 3/4"
UFH-0405SLT03	1 pc.	1/2" - 3 x 3/4"
UFH-0405SLT04	1 pc.	1/2" - 4 x 3/4"
UFH-0405SLT05	1 pc.	1/2" - 5 x 3/4"
UFH-0405SLT06	1 pc.	1/2" - 6 x 3/4"
UFH-0405SLT07	1 pc.	3/4" - 7 x 3/4"
UFH-0405SLT08	1 pc.	3/4" - 8 x 3/4"
UFH-0405SLT09	1 pc.	3/4" - 9 x 3/4"
UFH-0405SLT10	1 pc.	3/4" - 10 x 3/4"
UFH-0405SLT11	1 pc.	3/4" - 11 x 3/4"
UFH-0405SLT12	1 pc.	3/4" - 12 x 3/4"
UFH-0405SLT13	1 pc.	3/4" - 13 x 3/4"
UFH-0405SLT14	1 pc.	3/4" - 14 x 3/4"
UFH-0405SLT15	1 pc.	3/4" - 15 x 3/4"
UFH-0405SLT16	1 pc.	3/4" - 16 x 3/4"

Type: UFH-SSTN-PN6



Including cord, plug and maximum thermostat

Steel collector with pump, district heating nuon and eneco
Colector de acero con bomba, calefacción urbana "Nuon y eneco"
Coletor acero con bomba tipo A de aço com bomba, aquecimento coletivo "Nuon e eneco".

Article number	Packing	Type
UFH-0405SSTN01-PN6	1 pc.	1/2" - 1 x 3/4"
UFH-0405SSTN02-PN6	1 pc.	1/2" - 2 x 3/4"
UFH-0405SSTN03-PN6	1 pc.	1/2" - 3 x 3/4"
UFH-0405SSTN04-PN6	1 pc.	1/2" - 4 x 3/4"
UFH-0405SSTN05-PN6	1 pc.	1/2" - 5 x 3/4"
UFH-0405SSTN06-PN6	1 pc.	1/2" - 6 x 3/4"
UFH-0505SSTN07-PN6	1 pc.	3/4" - 7 x 3/4"
UFH-0505SSTN08-PN6	1 pc.	3/4" - 8 x 3/4"
UFH-0505SSTN09-PN6	1 pc.	3/4" - 9 x 3/4"
UFH-0505SSTN10-PN6	1 pc.	3/4" - 10 x 3/4"
UFH-0505SSTN11-PN6	1 pc.	3/4" - 11 x 3/4"
UFH-0505SSTN12-PN6	1 pc.	3/4" - 12 x 3/4"

Type: UFH-SSTE-PN6



Including cord, plug and maximum thermostat

Steel collector with pump, district heating essent
Colector de acero con bomba, calefacción urbana "Essent"
Coletor de aço com bomba, aquecimento coletivo "Essent"

Article number	Packing	Type
UFH-0405SSTE01-PN6	1 pc.	1/2" - 1 x 3/4"
UFH-0405SSTE02-PN6	1 pc.	1/2" - 2 x 3/4"
UFH-0405SSTE03-PN6	1 pc.	1/2" - 3 x 3/4"
UFH-0405SSTE04-PN6	1 pc.	1/2" - 4 x 3/4"
UFH-0405SSTE06-PN6	1 pc.	1/2" - 6 x 3/4"
UFH-0505SSTE07-PN6	1 pc.	3/4" - 7 x 3/4"
UFH-0505SSTE08-PN6	1 pc.	3/4" - 8 x 3/4"
UFH-0505SSTE09-PN6	1 pc.	3/4" - 9 x 3/4"
UFH-0505SSTE10-PN6	1 pc.	3/4" - 10 x 3/4"
UFH-0505SSTE11-PN6	1 pc.	3/4" - 11 x 3/4"
UFH-0505SSTE12-PN6	1 pc.	3/4" - 12 x 3/4"



B. MANIFOLDS

1 Type: UFH-C192071



Safety thermostat incl. wire/plug
Termostato con cable / enchufe
Termóstato com cabo e ficha

Article number	Packing	Type
UFH-C192071	1 pc.	

6 Type: UFH-C191800



Thermometer with immersion sleeve 0/60 gr.
Termómetro con tubo de inmersión.
Termómetro com tubo de imersão

Article number	Packing	Type
UFH-C191800	1 pc.	

11 Type: UFH-C191974 - 76



Circulator Wilo Yonos Para RS 15/6-RKA KU 130mm (excl. wire/plug)
Bomba circuladora wilo yonos 15/6 rka ku 130mm 1"
Bomba de circulação Wilo Yonos 15/6 130mm ligação 1"

Article number	Packing	Type
UFH-C191974		1"
UFH-C191976		1 1/2"

C. CONTROL UNITS



WIRED CONTROL UNIT

UNIDAD DE CONTROL CON CABLE

UNIDADE DE CONTROLO COM FIO

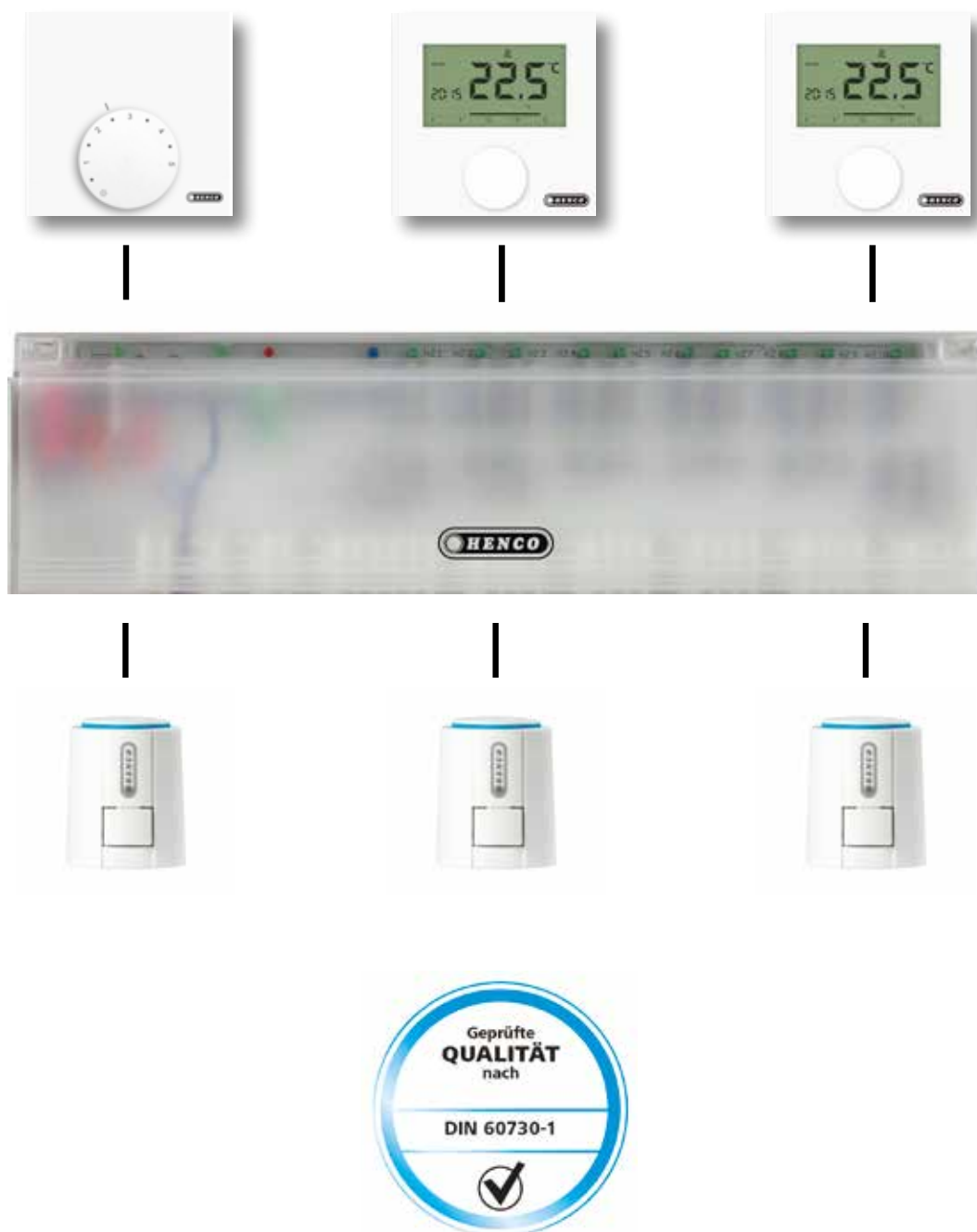

- 1
- 2
- 3
- 4
- 5
- 6
- 7
- 8
- 9
- 10
- 11
- 12

C. CONTROL UNITS

Type: CU-6ZONE



Base module 6 zones, transformer incl.
Módulo básico 6 zonas, transformador incl.
Módulo base 6 zonas, transformador incl.

Article number	Packing	Type
CU-6ZONE-24V	1 pc.	24V
CU-6ZONE-230V	1 pc.	230V

Type: CU-6ZONEP



Base module Plus 6 zones, transformer incl. (heating/cooling with pump contact)
Módulo base Plus 6 zonas, transformador incl. (calefacción / refrigeración con contacto de bomba)
Módulo base Plus 6 zonas, transformador incl. (aquecimento / resfriamento com contato da bomba)

Article number	Packing	Type
CU-6ZONEP-24V	1 pc.	24V
CU-6ZONEP-230V	1 pc.	230V

Type: CU-6ZONEK



Base module Comfort 6 zones, transformer (heating/cooling with pump contact and boiler contact)
Módulo base Comfort 6 zonas, transformador (calefacción / refrigeración con contacto bomba y contacto caldera)
Módulo base Comfort 6 zonas, transformador (aquecimento / resfriamento com contato bomba e contato caldeira)

Article number	Packing	Type
CU-6ZONEK-24V	1 pc.	24V
CU-6ZONEK-230V	1 pc.	230V

Type: CU-10ZONEK



Base module Comfort 10 zones, transformer (heating/cooling with pump contact and boiler contact)
Módulo base Comfort 10 zonas, transformador (calefacción / refrigeración con contacto bomba y contacto caldera))
Módulo básico Comfort 10 zonas, transformador (aquecimento / resfriamento com contato da bomba e contato da caldeira)

Article number	Packing	Type
CU-10ZONEK-24V	1 pc.	24V
CU-10ZONEK-230V	1 pc.	230V

Type: CU-DINRAIL



Din rail
Riel DIN
Calha DIN

Article number	Packing	Type
CU-DINRAIL	1 pc.	



Type: CU-REGB



Analog thermostat
Termostato analógico
Termóstato analógico

Article number	Packing	Type
CU-REGB-24V	1 pc.	24V
CU-REGB-230V	1 pc.	230V

Type: CU-REGB-HC



Analog thermostat, heating/cooling
Termostato analógico, calefacción / refrigeración
Termóstato analógico, aquecimento / resfriamento

Article number	Packing	Type
CU-REGB-HC24V	1 pc.	24V
CU-REGB-HC230V	1 pc.	230V

Type: CU-REGK



LCD komfort thermostat 24V, heating/cooling
LCD Confort termostato
Termóstato LCD Komfort

Article number	Packing	Type
CU-REGK-24V	1 pc.	24V
CU-REGK-230V	1 pc.	230V

Type: CU-REGC



LCD control thermostat 230V, heating/cooling + clock program
Control LCD termostato
Termóstato controlo LCD

Article number	Packing	Type
CU-REGC-24V	1 pc.	24V
CU-REGC-230V	1 pc.	230V

Type: CU-ACT



Act with cable 1m
Cabezal termostato con cable 1 m
Cabezal termostato para Plugable

Article number	Packing	Type
CU-ACT-24V	1 pc.	24V
CU-ACT-230V	1 pc.	230V
CU-ACT-B230V	1 pc.	230V

Type: CU-ACT-PLUG



Act for plugable
Actuador para el cable enchufable
Agir para plugável

Article number	Packing	Type
CU-ACT-24V-PLUG	1 pc.	24V
CU-ACT-230V-PLUG	1 pc.	230V

1

2

3

4

5

6

7

8

9

10

11

12



C. CONTROL UNITS

1 Type: CU-PLUGCABLE



Act plugcable
Act cable enchufe
Ficha com cabo

Article number	Packing	Type
CU-PLUGCABLE-2M	1 pc.	2 m
CU-PLUGCABLE-5M	1 pc.	5 m
CU-PLUGCABLE-15M	1 pc.	15 m

7 Type: UFH-ANC



Valve
Válvulas
Válvulas

Article number	Packing	Type
UFH-ANC-05	1 pc.	2 x 3/4" - M30x1,5 - Kv 2
UFH-ANC-06	1 pc.	2 x 1" - M30x1,5 - Kv 4,5



WIRELESS CONTROL UNIT (HEATING / COOLING)

UNIDAD DE CONTROL INALÁMBRICA (CALEFACCIÓN / REFRIGERACIÓN)

UNIDADE DE CONTROLE SEM FIO (AQUECIMENTO / REFRIGERAÇÃO)

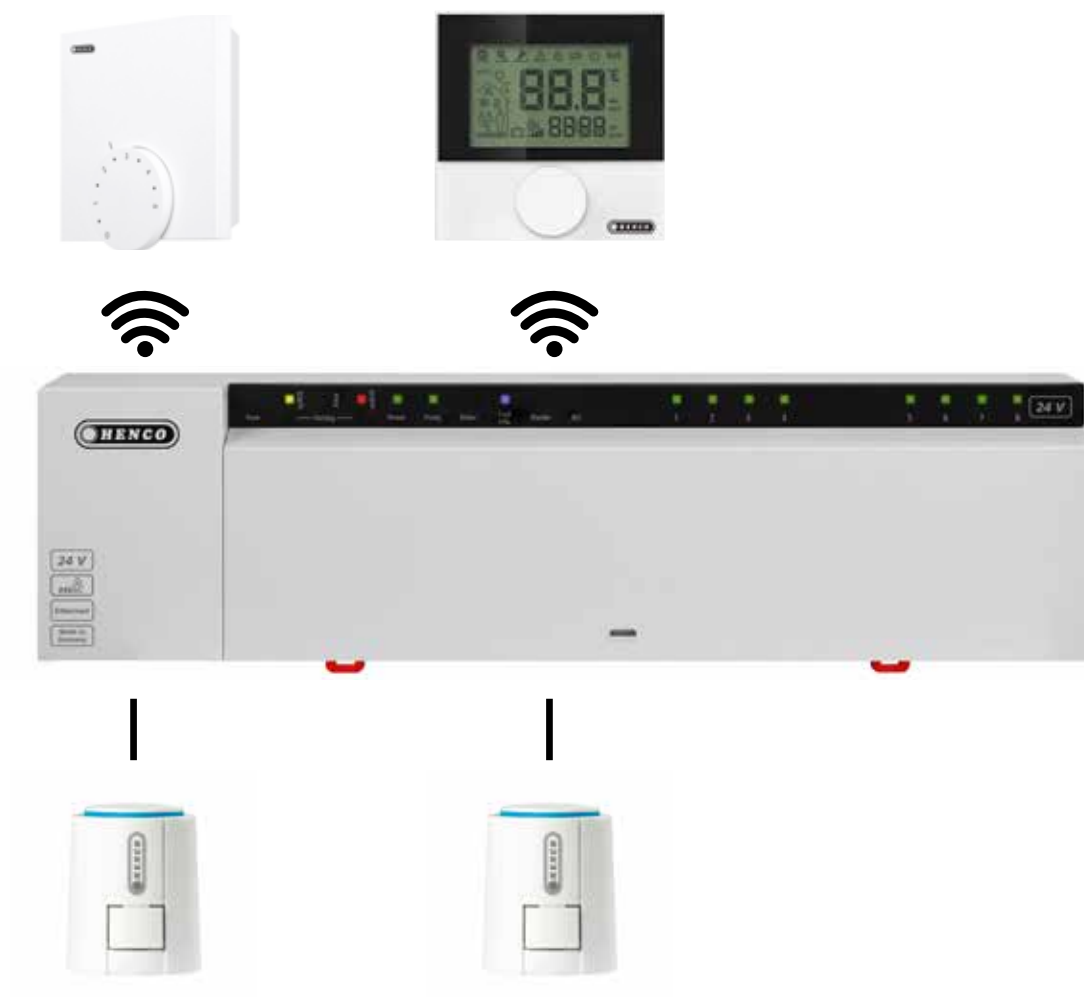

1

2

3

4

5

6

7

8

9

10

11

12



C. CONTROL UNITS

1

Type: CU-MONO-RF



One zone module 230V
Módulo una zona, 230 V
Módulo de uma zona, 230 V

Article number	Packing	Type
CU-MONO-RF	1 pc.	

2

3

4

5

6

Type: CU-8ZONE-RF



Base module 8 zones, 230V LAN DIN rail incl. (heating/cooling)
Módulo base 8 zonas, carril DIN 230V LAN incl. (refrigeración calefacción)
Módulo base 8 zonas, trilho DIN 230 V LAN incl. (aquecimento / resfriamento)

Article number	Packing	Type
CU-8ZONE-RF	1 pc.	

7

8

9

10

11

Type: CU-8ZONEB-RF



Base module 8 zones, 230V DIN rail incl. (heating/cooling)
Módulo base 8 zonas, carril DIN 230V incl. (refrigeración calefacción)
Módulo base 8 zonas, trilho DIN 230V incl. (aquecimento / resfriamento)

Article number	Packing	Type
CU-8ZONEB-RF	1 pc.	

12

Type: CU-12ZONE-RF



Base module 12 zones, 230V LAN din rail incl. (heating/cooling)
Módulo base 12 zonas, carril din LAN 230V incl. (refrigeración calefacción)
Módulo base 12 zonas, trilho DIN 230V LAN incl. (aquecimento / resfriamento)

Article number	Packing	Type
CU-12ZONE-RF	1 pc.	

Type: CU-REGB-RF



Analog thermostat, 0-5 incl. batt (heating/cooling)
Termostato analógico
Termóstato analógico

Article number	Packing	Type
CU-REGB-RF	1 pc.	



Type: CU-REGC-RF



Thermostat LCD, optional ext. sensor
Control LCD termostato
Termóstato controlo LCD

Article number	Packing	Type
CU-REGC-RF	1 pc.	

Type: CU-REGS-RF



Tamper free sensor
Sensor libre de manipulaciones
Sensor livre de violação

Article number	Packing	Type
CU-REGS-RF	1 pc.	

Type: CU-REPEAT



Repeater
Repetidor
Repetidor

Article number	Packing	Type
CU-REPEAT	1 pc.	

Type: CU-ANT



Antenne
Antena con cable 1 m
Antena cm fio 1 m

Article number	Packing	Type
CU-ANT	1 pc.	

Type: CU-SENS



External sensor
Sensor externo
Sensor exterior

Article number	Packing	Type
CU-SENS	1 pc.	3 m

1

2

3

4

5

6

7

8

9

10

11

12



C. CONTROL UNITS

1

Type: CU-ACT-230V-PLUG

2

3

4

5



Act for plugcable, 230V
Act para cable enchufable, 230V
Atuar para plugável, 230 V

Article number	Packing	Type
CU-ACT-230V-PLUG	1 pc.	

6

Type: CU-PLUGCABLE

7

8

9

10

11

12



Act plugcable
Act cable enchufe
Ficha com cabo

Article number	Packing	Type
CU-PLUGCABLE-2M	1 pc.	2 m
CU-PLUGCABLE-5M	1 pc.	5 m
CU-PLUGCABLE-15M	1 pc.	15 m

Type: UFH-H5004



Copper shroud for UFH-SENSOR
Cubierta de cobre para UFH-SENSOR
Cobertura de cobre para UFH-SENSOR

Article number	Packing	Type
UFH-H5004	1 pc.	50 mm x 1/2"

Type: UFH-ANC



Valve
Valvulas
Válvulas

Article number	Packing	Type
UFH-ANC-05	1 pc.	2 x 3/4" - M30x1,5 - Kv 2
UFH-ANC-06	1 pc.	2 x 1" - M30x1,5 - Kv 4,5





1 **Type: UFH-CAB-I**



Recessed manifold cabinet, RAL 9016
Armario colector empotrado RAL 9016
Armário embutir, RAL 9016

Article number	Packing	Type
UFH-CAB-I400	1 pc.	400x700-800x112-152mm
UFH-CAB-I600	1 pc.	600x700-800x112-152mm
UFH-CAB-I800	1 pc.	800x700-800x112-152mm
UFH-CAB-I1000	1 pc.	1000x700-800x112-152mm

2
3
4
5
6
7
8 **Type: UFH-CAB-O**



Surface mount manifold cabinet, RAL 9016
Armario colector de montaje en superficie RAL 9016
Armário de chão, RAL 9016

Article number	Packing	Type
UFH-CAB-O400	1 pc.	400x720x112mm
UFH-CAB-O600	1 pc.	600x720x112mm
UFH-CAB-O800	1 pc.	800x720x112mm
UFH-CAB-O1000	1 pc.	1000x720x112mm



Press machines, press jaws and calibrating tools should be checked on a regular base when used intensively.

Las máquinas de prensado, las mordazas de prensado y las herramientas de calibración deben revisarse periódicamente cuando se utilizan de forma intensiva.

Máquinas de prensar, mordentes de prensa e ferramentas de calibragem devem ser verificadas numa base regular quando usadas intensivamente.



Type: BI

- 1
- 2
- 3
- 4
- 5
- 6
- 7
- 8
- 9
- 10
- 11
- 12



Internal bending spring
Muelle interior para tubo
Mola interior para tubo

Article number	Bag / Box	Type
BI-1410	1 pc. / 100 pc.	14x2 L=50 cm
BI-1612	1 pc. / 100 pc.	16x2 L=50 cm
BI-1612L	1 pc. / 50 pc.	16x2 L=100 cm
BI-1814	1 pc. / 75 pc.	18x2 L=50 cm
BI-2016	1 pc. / 75 pc.	20x2 L=50 cm
BI-2016L	1 pc. / 25 pc.	20x2 L=100 cm
BI-2620	1 pc. / 25 pc.	26x3 L=100 cm

Type: BA



External bending spring
Muelle exterior para tubo L=50
Mola externa de curvar tubos L=50

Article number	Bag / Box	Type
BA-1288	1 pc. / 50 pc.	12x1,88 L=50 cm
BA-1410	1 pc. / 50 pc.	14x2 L=50 cm
BA-1612	1 pc. / 50 pc.	16x2 L=50 cm
BA-1814	1 pc. / 50 pc.	18x2 L=50 cm
BA-2016	1 pc. / 50 pc.	20x2 L=50 cm

Type: BM



Bending tool
Curvadora manual
Curvadora manual

Article number	Packing	Type
BM-16	1 pc.	for Ø16
BM-18	1 pc.	for Ø18
BM-20	1 pc.	for Ø20
BM-26	1 pc.	for Ø26

Type: BM-F



Fast bending tool
Herramienta de plegado rápido
Ferramenta de dobragem rápida

Article number	Packing	Type
BM-16F	1 pc.	for Ø16
BM-20F	1 pc.	for Ø20

Type: IMPRESS-N



Guillotine cutter
Tijera guillotina
Tesoura de guilhotina

Article number	Packing	Type
IM1426PRESS-N	1 pc.	14 till 26 mm



Type: IMPRESS



Guillotine cutter mantle pipe cutter in handle
Tijera guillotina con cortatubos en mango
Tesoura de guilhotina

Article number	Packing	Type
IM1426PRESS	1 pc.	14 till 26 mm

Type: IMEM-PRESS



Replacement blade for IM1426-PRESS(-N)
Cuchilla repuesto para IM1426-PRESS(-N)
Lâmina para para IM1426-PRESS(-N)

Article number	Packing	Type
IMEM1426-PRESS	1 pc.	for IM1426PRESS

Type: RSEM-PERS



Replacement blade for art. RS1420PRESS and RS2640PRESS
Cuchilla repuesto tijera 20mm
Lâmina para tesoura 20mm

Article number	Packing	Type
RSEM1420-PERS	1 pc.	14 till 20 mm
RSEM2640-PERS	1 pc.	26 till 40 mm

Type: IM



Wheel cutter
Cortatubos 14mm - 63mm
Corta tubos 14mm - 63mm

Article number	Packing	Type
IM63	1 pc.	14 till 63 mm

Type: IMEM



Replacement blade for IM 63
Cuchilla repuesto para IM 63
Lâmina para para IM 63

Article number	Packing	Type
IMEM63	1 pc.	for IMEM63

Type: RS



Wheel cutter
Cortador de ruedas
Cortador de rodas

Article number	Packing	Type
RS32	1 pc.	14 till 32 mm

TILL EXHAUSTION OF STOCK



1 **Type: SAFECUT**



Cutter to open the packing paper
Cortador para abrir el embalaje de los rollos
Cortador para abrir a embalagem dos rolos

Article number	Packing	Type
SAFECUT	1 pc.	SAFECUT

2
3
4
5 **Type: PS**



Pipe straightener
Enderezadora de tubos
Máquina de endireitar tubo multicamada

Article number	Packing	Type
PS-16	1 pc.	Ø16
PS-20	1 pc.	Ø20

6
7
8
9 **Characteristics PS / Características PS / Características PS**

- ▶ Simplifies installation and reduces labour / Simplifica la instalación y reduce la mano de obra / Simplifica a instalação e reduz a mão-de-obra
- ▶ Easy to use / Facilidad de uso / Fácil de usar
- ▶ Less material usage and waste / Menos uso de material y residuos / Menor utilização de material e desperdício
- ▶ Accelerated flow for better efficiencies and reduced running costs / Flujo acelerado para mejorar la eficiencia y reducir los costes de funcionamiento / Fluxo acelerado para uma melhor eficiência e redução dos custos de funcionamento
- ▶ Professional looking finish / Acabado de aspecto profesional / Acabamento com aspecto profissional

Type: KS-MSET1



Set with KS-K and KS-M for Ø16, 20 and 26
Calibrador circular 16, 20, 26
Calibrador circular 16, 20, 26

Article number	Packing	Type
KS-MSET1	1 pc.	MSET1

Type: KS-MSET4



Set with KS-K and KS-M for Ø16, 20, 26 and 32
Calibrador circular 16, 20, 26 y 32
Calibrador circular 16, 20, 26 e 32

Article number	Packing	Type
KS-MSET4	1 pc.	MSET4



Type: KS



Kalispeed for electric drills (max. 500 rpm, clockwise only)

Calibrador metal compatible con taladro

Calibrador metalico

Article number	Packing	Type
KS50	1 pc.	for Ø50
KS63	1 pc.	for Ø63

Type: KS-M



Kalispeed, metal, for KS-K and electric drills (max. 500 rpm, clockwise only)

Calibrador metal compatible con taladro KS-K

Manipulo calibrador KS-K)

Article number	Packing	Type
KS12M	1 pc.	for Ø12
KS14M	1 pc.	for Ø14
KS16M	1 pc.	for Ø16
KS18M	1 pc.	for Ø18
KS20M	1 pc.	for Ø20
KS26M	1 pc.	for Ø26
KS32M	1 pc.	for Ø32
KS40M	1 pc.	for Ø40

Type: KS-K



Clickhandle for KS (Kalispeed)

Mango calibrador KS

Calibrador metalico KS

Article number	Packing	Type
KS-K	1 pc.	up to Ø26 mm

Type: KS-P



Kalispeed for Ø16, 20 and 26

Calibrador circular plástico 16, 20, 26

Calibrador plástico circular 16, 20, 26

Article number	Packing	Type
KS-P162026	1 pc.	for Ø16, 20 and 26

Not for intensive use



Characteristics PH-1632 / CARACTERÍSTICAS PH-1632

- ▶ Always sufficient grip when calibrating short pipe ends / Siempre tiene suficiente agarre cuando se calibran extremos de tubos cortos / Sempre aderência suficiente ao calibrar extremidades curtas de tubos
- ▶ Prevents the pipe from turning during calibration / Evita que el tubo gire durante el calibrado / Impede o tubo de virar durante a calibração
- ▶ Inspired by the classic nutcracker model / Inspirado en el modelo clásico de cascanueces / Inspirado no modelo clássico do quebra-nozes
- ▶ Henco blue anodised aluminium / Aluminio anodizado azul Henco / Henco alumínio anodizado azul
- ▶ Lightweight tool / Herramienta ligera / Ferramenta leve
- ▶ Suitable for pipe diameters of 16 -20 -26 -32 / Adecuada para diámetros de tubo de 16 -20 -26 -32 / Adequado para diâmetros de tubo de 16 -20 -26 -32



Type: PH-1632



Pipe holder for diameters 16-20-26-32

Sujetatubos para tubos diámetros 16-20-26-32

Suporte de tubos para diâmetros de tubos 16-20-26-32mm

Article number	Packing	Type
PH-1632	1 pc.	up to 32 mm

Type: M-BA03



Kit: battery press machine including battery + charge unit + case, linear drive 32 kN, up to Ø 63

Kit: máquina de prensado a batería que incluye batería + unidad de carga + maletín, accionamiento lineal 32 kN, hasta Ø 63

Kit: máquina de prensar batería incluindo bateria + unidade de carga + caixa, transmissão linear 32 kN, até Ø 63

Article number	Packing	Type
M-BA03	1 pc.	BA03

Type: M-BAT03



Battery for M-BA03

Batería para M-BA03

Bateria para M-BA03

Article number	Packing	Type
M-BAT03	1 pc.	BAT03

Type: M-LAD03



Charge-unit for M-BA03, M-BMINI2

Cargador para M-BA03, M-BMINI

Carregador para M-BA03, M-BMINI

Article number	Packing	Type
M-LAD03	1 pc.	LAD03



Type: M-TRANS03



Mains Adapter for M-BA03
Adaptador de red para M-BA03
Adaptador principal para M-BA03

Article number	Packing	Type
M-TRANS03	1 pc.	TRANS03

Type: M-BOXBA03



Case for M-BA03
Estuche para M-BA03
Caso para M-BA03

Article number	Packing	Type
M-BOXBA03	1 pc.	BOX M-BA03

Type: M-BHY162026



Kit : 230 volt hydraulic press machine with 16, 20, 26 jaws + metal case (110 volt also available), linear drive 32 to 40 kN

Kit: máquina de prensado hidráulica de 230 voltios con mordazas 16, 20, 26 + caja metálica (110 voltios también disponible), accionamiento lineal de 32 a 40 kN

Kit : prensa hidráulica de 230 volts com 16, 20, 26 mandíbulas + caixa metálica (110 volts também disponível), acionamento linear 32 a 40 kN

Article number	Packing	Type
M-BHY162026	1 pc.	Ø14-63

- 1
- 2
- 3
- 4
- 5
- 6
- 7
- 8
- 9
- 10
- 11
- 12



1 **Type: M-BHY**



Kit : 230 volt hydraulic press machine + metal case (110 volt also available), linear drive 32 to 40 kN

Kit: máquina de prensado hidráulica de 230 voltios + maletín metálico (también disponible en 110 voltios), accionamiento lineal de 32 a 40 kN

Kit : prensa hidráulica de 230 volts + caixa metálica (110 volts também disponível), acionamento linear 32 a 40 kN

Article number	Packing	Type
M-BHY	1 pc.	Ø14-63

8 **Type: M-BOXBHY**



Metal case for M-BHY162026

Caja para M-BHY162026

Caixa para M-BHY162026

Article number	Packing	Type
M-BOXBHY	1 pc.	Ø14-63

10 **Type: BE**



Jaws (universal)

Mordaza BE

Mordente BE

Article number	Packing	Type
BE14	1 pc.	BE/TH 14x2
BE16	1 pc.	BE/TH 16x2
BE18	1 pc.	BE/TH 18x2
BE20	1 pc.	BE/TH 20x2
BE26	1 pc.	BE/TH 26x3
BE32	1 pc.	BE 32x3
BE40	1 pc.	BE 40x3,5
BE50	1 pc.	BE 50x4
BE63	1 pc.	BE 63x4,5

Press tool compatibility: see technical manual

11 **Type: BE-UNISSET1**



Set with universal jaw mounting unit and BE-H inserts Ø16, 20 and 26

Juego pinza madre + inserciones BE-H Ø16, 20, 26

Kit mordentes base + encaixe BE-H Ø16, 20, 26

Article number	Packing	Type
BE-UNISSET1	1 pc.	UNISSET1

Press tool compatibility: see technical manual



Type: BE-UNISSET2



Set with universal jaw mounting unit and BE-H inserts Ø14, 16, 18, 20, 26, and 32
 Juego pinza madre + inserciones BE-H Ø14, 16, 18, 20, 26 y 32
 Kit mordentes base + encaixe BE-H Ø14, 16, 18, 20, 26, t 32

Article number	Packing	Type
BE-UNISSET2	1 pc.	UNISSET2

Press tool compatibility: see technical manual

Type: BE-UNISSETMINI3



Set with jaw be-mini3 + be-h inserts ø16,20,26,32
 Conjunto con pinza madre be-mini3 + inserciones be-h be-h ø16, 20, 26 y 32
 Conjunto com inserções de mandíbula be-mini3 + be-h be-h ø16,20,26 e 32

Article number	Packing	Type
BE-UNISSETMINI3	1 st.	UNISSETMINI3

Press tool compatibility: see technical manual

Type: TOOLBOX16202632



Box with KS16 20 26 32 M, BE-UNI, BE16 20 26 32 H, BI-1612, BI-2016, BA-1612, BA-2016, IM1426PRESS, SAFECUT
 Caja completa inserciones y calibradores de 16,20,26,32
 Caixa completa com mordentes e calibrador 16,20,26,32 mm

Article number	Packing	Type
TOOLBOX16202632	1 pc.	TOOLBOX16202632

Type: TOOLBOX405063



Box with KS40M, KS50, KS63, BE40 50 63, IM63
 Caja completa mordazas y calibradores de 40,50,63
 Caixa completa com mordentes e calibrador 40,50,63 mm

Article number	Packing	Type
TOOLBOX405063	1 pc.	TOOLBOX405063

- 1
- 2
- 3
- 4
- 5
- 6
- 7
- 8
- 9
- 10
- 11
- 12



1 **Type: BE-UNI**



Jaw mounting unit for M-BA03 and M-BHY, to be used with BE-H jaws
Pinza madre para inserciones de 16 a 32 para M-BA03 y M-BHY
Mordente base 16 a 32 para M-BA03 e M-BHY

Article number	Packing	Type
BE-UNI	1 pc.	BE-UNI

Press tool compatibility: see technical manual

BE-UNI is designed to press Henco press fittings, the interchangeable dies with M- and V-profile make it possible to make the transition from other materials to Henco other than Henco branded fittings with compact measurements can cause complex manipulation.

9 **Type: BE-H**



Inserts for BE-UNI, BE-MINI, BE-MINI2, BE-MINI3, M-BH
Inserción BE para BE-UNI, BE-MINI, BE-MINI2, BE-MINI3, M-BH
Encaixe para BE-UNI, BE-MINI, BE-MINI2, BE-MINI3, M-BH

Article number	Packing	Type
BE14H	1 Set (2 pc.)	BE/TH 14X2 H
BE16H	1 Set (2 pc.)	BE/TH 16X2 H
BE18H	1 Set (2 pc.)	BE/TH 18X2 H
BE20H	1 Set (2 pc.)	BE/TH 20X2 H
BE26H	1 Set (2 pc.)	BE/TH 26X3 H
BE32H	1 Set (2 pc.)	BE 32X3 H

Type: BE-HC



Inserts (copper) for BE-UNI, BE-MINI2, M-BH, BE-MINI3
Inserción (CU) BE-UNI, BE-MINI2, BE-MINI3, M-BH
Insercion (CU) BE-UNI, BE-MINI2, BE-MINI3, M-BH

Article number	Packing	Type
BE12HC	1 Set (2 pc.)	12Cu V-profile
BE14HC	1 Set (2 pc.)	14Cu V-profile
BE15HC	1 Set (2 pc.)	15Cu V-profile
BE16HC	1 Set (2 pc.)	16Cu V-profile
BE18HC	1 Set (2 pc.)	18Cu V-profile
BE22HC	1 Set (2 pc.)	22Cu V-profile
BE28HC	1 Set (2 pc.)	28Cu V-profile

Our warranty does not apply to other pipe systems with M or V profile



Type: BE-HM



Inserts (copper) for BE-UNI, BE-MINI2, M-BH, BE-MINI3

Inserción (CU) BE-UNI, BE-MINI2, BE-MINI3, M-BH

Encaixe (CU) BE-UNI, BE-MINI2, BE-MINI3, M-BH

Article number	Packing	Type
BE12HM	1 Set (2 pc.)	12Cu M-profile
BE15HM	1 Set (2 pc.)	15Cu M-profile
BE18HM	1 Set (2 pc.)	18Cu M-profile
BE22HM	1 Set (2 pc.)	22Cu M-profile

Our warranty does not apply to other pipe systems with M or V profile

Type: BE-BOX



Metal case for 6 compression jaws

Caja metálica para 4 mordazas

Caixa metálica para 4 mordentes

Article number	Packing	Type
BE-BOX	1 pc.	BOX

Type: M-BMINI3-F



Kit : compact rechargeable battery press machine with press monitoring + case + charge unit + battery 18V + full jaws TH16-20-26, linear drive ca. 19 kN

Máquina de prensar hidráulica con batería 18V y potencia de 19KN con mordazas de 16 a 26

Máquina prensar hidráulica com bateria 18V, potência 19KN

Article number	Packing	Type
M-BMINI3-F	1 pc.	Ø16-26 / 18V

Type: M-BMINI3



Kit : compact rechargeable battery press machine with press monitoring + case + charge unit + battery 18V + mother jaw + inserts TH16-20-26, linear drive ca. 19 kN

Máquina de prensar hidráulica con batería 18V y potencia de 19KN con mordaza madre y inserciones 16 a 26

Máquina prensar hidráulica com bateria 18V, potência 19KN

Article number	Packing	Type
M-BMINI3	1 pc.	Ø16-26 / 18V



1 **Type: M-BMINI3-S**



Kit : compact rechargeable battery press machine with press monitoring + case + charge unit + battery 18V, linear drive ca. 19 kN
 Máquina de prensar hidráulica con batería 18V y potencia de 19KN
 Máquina prensar hidráulica com bateria 18V, potência 19KN

Article number	Packing	Type
M-BMINI3-S	1 pc.	Ø16-26 / 18V

7 **Type: M-BATMINI3**



Battery 18V for M-BMINI3-F, M-BMINI3, M-BMINI3-S
 Batería 18V para M-BMINI3-F, M-BMINI3, M-BMINI3-S
 Bateria 18V para M-BMINI3-F, M-BMINI3, M-BMINI3-S

Article number	Packing	Typ
M-BATMINI3-1.5AH	1 pc.	18V / 1,5 Ah Li-ion
M-BATMINI3-2.0AH	1 pc.	18V / 20 Ah Li-ion
M-BATMINI3-3.0AH	1 pc.	18V / 3,0 Ah Li-ion
M-BATMINI3-5.0AH	1 pc.	18V / 3,5 Ah Li-ion

Type: M-LADMINI3



Charge-unit for M-BMINI3-F, M-BMINI3, M-BMINI3-S
 Cargador para M-BMINI3
 Cargador para M-BMINI3

Article number	Packing	Type
M-LADMINI3	1 pc.	for M-BATMINI3

Type: M-TRANSMINI3



Mains Adapter for M-BMINI3-F, M-BMINI3, M-BMINI3-S + 5m cable
 Cable alámbrico para M-BMINI3 5 metros
 Cabo para M-BMINI3 - 5 metros

Article number	Packing	Type
M-TRANSMINI3	1 pc.	18V / 230V



Type: M-BOXMINI3



Metal case for M-BMINI3, M-BMINI3-S
Caja metal para M-BMINI3
Caixa metálica para M-BMINI3

Article number	Packing	Type
M-BOXMINI3	1 pc.	M-BOXMINI3

Type: M-BOXMINI3-F



Metal case for M-BMINI3-F
Caja metal para M-BMINI3-F
Caixa metálica para M-BMINI3-F

Article number	Packing	Type
M-BOXMINI3-F	1 pc.	M-BOXMINI3-F

Type: BE-MINI3



Mother jaw press machine M-BMINI3 with BE-H inserts
Pinza madre para inserciones de 16 a 32 para M-BMINI3
Mordente base 16 a 32 para M-BMINI3

Article number	Packing	Type
BE-MINI3	1 pc.	BE-MINI3

Type: BE..-MINI3



Jaw for press machine M-BMINI3 - TH profile
Mordaza (M) para - perfil TH
Mordente (M) para - Perfil TH

Article number	Packing	Type
BE14MINI3	1 pc.	BE/TH Ø14
BE16MINI3	1 pc.	BE/TH Ø16
BE20MINI3	1 pc.	BE/TH Ø20
BE26MINI3	1 pc.	BE/TH Ø26
BE32MINI3	1 pc.	BE Ø32

- 1
- 2
- 3
- 4
- 5
- 6
- 7
- 8
- 9
- 10
- 11
- 12



1 **Type: BE.V-MINI3**



Jaw for press machine M-BMINI3 - V profile
Jaw for press machine M-BMINI3 - V-profile
Mordaza (V) para M-BMINI3

Article number	Packing	Type
BE15V-MINI3	1 pc.	V-profile 15mm
BE18V-MINI3	1 pc.	V-profile 18mm
BE22V-MINI3	1 pc.	V-profile 22mm
BE28V-MINI3	1 pc.	V-profile 28mm

Our warranty does not apply to other pipe systems with M or V profile

7 **Type: BE.M-MINI3**



Jaw for press machine M-BMINI3 - M profile
Mordaza (M) para M-BMINI3
Mordente (M) para M-BMINI3

Article number	Packing	Type
BE12M-MINI3	1 pc.	M-profile 12mm
BE15M-MINI3	1 pc.	M-profile 15mm
BE18M-MINI3	1 pc.	M-profile 18mm
BE22M-MINI3	1 pc.	M-profile 22mm
BE28M-MINI3	1 pc.	M-profile 28mm

Our warranty does not apply to other pipe systems with M or V profile

10 **Type: M-BATMINI2**



Battery 18V / 1,5 Ah Li-ion for M-BMINI2
Batería 18V / 1,5 Ah Li-ion para M-BMINI2
Bateria 18V / 1,5 Ah Li-ion para M-BMINI2

Article number	Packing	Typ
M-BATMINI2	1 pc.	18V / 1,5 Ah Li-ion

11 **Type: BE.-MINI**



Jaw for press machine M-BMINI2(-S) and M-HP32
Mordaza (M) para M-BMINI2(-S) y M-HP32
Mordente (M) para M-BMINI2(-S) e M-HP32

Article number	Packing	Type
BE16MINI	1 pc.	BE/TH Ø16
BE20MINI	1 pc.	BE/TH Ø20
BE26MINI	1 pc.	BE/TH Ø26
BE32MINI	1 pc.	BE Ø32

Not applicable to press machine type M-BMINI3



Type: BE.-MMINI



M-profile jaw (copper) for press machine M-BMINI2(-S) and M-HP32

Mordaza (M) M-BMINI(2)(-S) y M-HP32

Mordente (M) para M-BMINI(2)(-S) e M-HP32

Article number	Packing	Type
BE15MMINI	1 pc.	Ø15Cu M-Profile
BE22MMINI	1 pc.	Ø22Cu M-Profile

Not applicable to press machine type M-BMINI3

Type: BE-C



V-profile jaw (copper) for press machine M-BMINI2(-S) and M-HP32

Mordaza v para M-BMINI2(-S) and M-HP32

Mordente V para M-BMINI2(-S) e M-HP32

Article number	Packing	Type
BE15C	1 pc.	Ø15Cu V-Profile
BE18C	1 pc.	Ø18Cu V-Profile
BE22C	1 pc.	Ø22Cu V-Profile
BE28C	1 pc.	Ø28Cu V-Profile

Not applicable to press machine type M-BMINI3

Our warranty does not apply to other pipe systems with M or V profile

Type: BE-MINI



Jaw mounting unit for [press machine] M-BMINI2(-S) / M-HP32, to be used with BE-H jaws

Pinza madre para inserciones de 16 a 32 para M-BMINI(2)(-S) / M-HP32

Mordente base para 16 a 32 Encaixe para M-BMINI(2)(-S) / M-HP32

Article number	Packing	Type
BE-MINI	1 pc.	BE-MINI

BE-MINI is designed to press Henco press fittings, the interchangeable dies with M- and V-profile make it possible to make the transition from other materials to Henco; other than Henco branded fittings with compact measurements can cause complex manipulation



Type: BE-H



Inserts for BE-UNI, BE-MINI2, BE-MINI3, M-BH

Inserción BE para BE-UNI, BE-MINI2, BE-MINI3, M-BH

Encaixe para BE-UNI, BE-MINI2, BE-MINI3, M-BH

Article number	Packing	Type
BE14H	1 Set (2 pc.)	BE/TH 14X2 H
BE16H	1 Set (2 pc.)	BE/TH 16X2 H
BE18H	1 Set (2 pc.)	BE/TH 18X2 H
BE20H	1 Set (2 pc.)	BE/TH 20X2 H
BE26H	1 Set (2 pc.)	BE/TH 26X3 H
BE32H	1 Set (2 pc.)	BE 32X3 H

Type: BE-HC



Inserts (copper) for BE-UNI, BE-MINI2, M-BH, BE-MINI3

Inserciones (cobre) para BE-UNI, BE-MINI2, M-BH, BE-MINI3

Encaixe (CU) BE-UNI, BE-MINI2, BE-MINI3, M-BH

Article number	Packing	Type
BE12HC	1 Set (2 pc.)	12Cu V-profile
BE14HC	1 Set (2 pc.)	14Cu V-profile
BE15HC	1 Set (2 pc.)	15Cu V-profile
BE16HC	1 Set (2 pc.)	16Cu V-profile
BE18HC	1 Set (2 pc.)	18Cu V-profile
BE22HC	1 Set (2 pc.)	22Cu V-profile
BE28HC	1 Set (2 pc.)	28Cu V-profile

Our warranty does not apply to other pipe systems with M or V profile

Type: BE-HM



Inserts (copper) for BE-UNI, BE-MINI2, M-BH, BE-MINI3

Inserciones (cobre) para BE-UNI, BE-MINI2, M-BH, BE-MINI3

Encaixe (CU) BE-UNI, BE-MINI2, BE-MINI3, M-BH

Article number	Packing	Type
BE12HM	1 Set (2 pc.)	12Cu M-profile
BE15HM	1 Set (2 pc.)	15Cu M-profile
BE18HM	1 Set (2 pc.)	18Cu M-profile
BE22HM	1 Set (2 pc.)	22Cu M-profile

Our warranty does not apply to other pipe systems with M or V profile



Type: M-HP



Hydraulic manual press tool + bag, exclusive jaws

Máquina de prensar manual hasta 32 con bolsa y sin mordazas, excluyendo la pelvis
Máquina prensar manual até 32mm sem mordentes, excluindo a pélvis

Article number	Packing	Type
M-HP32	1 pc.	Ø14-32

Type: M-BH



Kit: manual press machine + inserts 16,20,26 + bag

Máquina de prensar manual con inserciones 16,20,26 y bolsa

Maquina prensar manual com mordentes 16,20,26mm

Article number	Packing	Type
M-BH162026	1 pc.	BH 16x2 / 20x2 / 26x3

Not for intensive use

Type: BE-H



Inserts for BE-UNI, BE-MINI2, BE-MINI3, M-BH

Inserción BE para BE-UNI, BE-MINI2, BE-MINI3, M-BH

Encaixe para BE-UNI, BE-MINI2, BE-MINI3, M-BH

Article number	Packing	Type
BE14H	1 Set (2 pc.)	BE/TH 14X2 H
BE16H	1 Set (2 pc.)	BE/TH 16X2 H
BE18H	1 Set (2 pc.)	BE/TH 18X2 H
BE20H	1 Set (2 pc.)	BE/TH 20X2 H
BE26H	1 Set (2 pc.)	BE/TH 26X3 H
BE32H	1 Set (2 pc.)	BE 32X3 H

Our warranty does not apply to other pipe systems with M or V profile

Type: BE-HC



Inserts (copper) for BE-UNI, BE-MINI2, M-BH, BE-MINI3

Inserción BE para BE-UNI, BE-MINI2, BE-MINI3, M-BH

Inserções (cobre) para BE-UNI, BE-MINI2, M-BH, BE-MINI3

Article number	Packing	Type
BE12HC	1 Set (2 pc.)	12Cu V-profile
BE14HC	1 Set (2 pc.)	14Cu V-profile
BE15HC	1 Set (2 pc.)	15Cu V-profile
BE16HC	1 Set (2 pc.)	16Cu V-profile
BE18HC	1 Set (2 pc.)	18Cu V-profile
BE22HC	1 Set (2 pc.)	22Cu V-profile
BE28HC	1 Set (2 pc.)	28Cu V-profile

Our warranty does not apply to other pipe systems with M or V profile



Type: BE-HM



Inserts (copper) for BE-UNI, BE-MINI2, M-BH, BE-MINI3
 Insertos (cobre) para BE-UNI, BE-MINI2, M-BH, BE-MINI3
 Inserções (cobre) para BE-UNI, BE-MINI2, M-BH, BE-MINI3

Article number	Packing	Type
BE12HM	1 Set (2 pc.)	12Cu M-profile
BE15HM	1 Set (2 pc.)	15Cu M-profile
BE18HM	1 Set (2 pc.)	18Cu M-profile
BE22HM	1 Set (2 pc.)	22Cu M-profile

Our warranty does not apply to other pipe systems with M or V profile

Type: M-BM1620



Kit: manual press machine with 16, 20 jaws
 Kit: máquina manual de prensado con mordazas 16, 20
 Kit: máquina de imprensa manual com 16, 20 mandíbulas

Article number	Packing	Type
M-BM1620	1 pc.	BM 16x2 / 20x2

Type: BE-M



Inserts for M-BM1620
 Inserción BE para M-BM1620
 Encaixe BE para M-BM1620

Article number	Packing	Type
BE14M	1 Set (2 pc.)	BE 14X2 M
BE16M	1 Set (2 pc.)	BE 16X2 M
BE18M	1 Set (2 pc.)	BE 18X2 M
BE20M	1 Set (2 pc.)	BE 20X2 M

Type: PRESSCHECK



Tool to check the accuracy of a pressing
 Presscheck control prensado
 Presscheck controlo de cravamento

Article number	Packing	Type
PRESSCHECK1432	1 pc.	Ø14-32



Type: DRILLY



Drilly temporary air vent plug, reusable
Tapón de ventilación temporal reutilizable
Ficha metálica reutilizável

Article number	Packing	Type
DRILLY14	1 pc.	Ø14
DRILLY16	1 pc.	Ø16
DRILLY20	1 pc.	Ø20
DRILLY26	1 pc.	Ø26
DRILLY32	1 pc.	Ø32

Type: PLUG



Plug
Tapón prueba presión
Tampão teste de pressão

Article number	Packing	Type
PLUG04-B80	20 pc.	1/2" - 80 mm blue
PLUG04-R80	20 pc.	1/2" - 80 mm red
PLUG05-B80	20 pc.	3/4" - 80 mm blue
PLUG05-R80	20 pc.	3/4" - 80 mm red

Type: UFH-VLA



Decoiler, standard model
Desbobinador estándar rollos 600 mettos
Desenrolador para rolos de 600 metros

Article number	Packing	Type
UFH-VLA	1 pc.	25 m - 600 m

Minimum inner diameter coil: 140mm

Type: UFH-VLA-STR



Pipe straightener for decoiler UFH-VLA 14-26 mm
Enderezadora de tubos para desbobinador UFH-VLA 14-26 mm
Endireitador de tubos para desenrolador UFH-VLA 14-26 mm

Article number	Packing	Type
UFH-VLA-STR	1 pc.	

Type: UFH-VLA-STRHO



Holder for pipe straightener ufh-vla-str 14-26mm
Soporte para enderezador de tubos ufh-vla-str 14-26mm
Suporte para alisador de tubos ufh-vla-str 14-26mm

Article number	Packing	Type
UFH-VLA-STRHO	1 pc.	Clamp



1

Type: UFH-TACK

2

3

4

5

6



Tacker machine for UFH-TACK-40, UFH-TACK-60
 Máquina grapadora para UFH-TACK-40, UFH-TACK-60
 Agrafadora para UFH-TACK-40, UFH-TACK-60

Article number	Packing	Type
UFH-TACK	1 pc.	for UFH-TACK-40 / UFH-TACK-60

7

Type: UFH-RAS-VLE

8

9

10

11

12



Braid hook
 Gancho trenzado
 Gancho trançado

Article number	Packing	Type
UFH-RAS-VLE	1 pc.	

Type: UFH-RAS-CUT



Cutter for steel mesh
 Pinza corta mallazo
 Tesoura de corte malha de aço

Article number	Packing	Type
UFH-RAS-CUT	1 pc.	

Type: HNTOOLSET



Toolset for the Super Sizes range
 Juego de herramientas para la gama Super Sizes
 Ferramenta, gama grandes diâmetros

Article number	pc	Type
HNTOOLSET	1 pc.	Super Size



Type: PK-TOOL



Wrench for PK/SK fittings with threading
Llave para accesorios PK/SK con roscado
Chave para acessórios PK/SK roscados

Article number	Packing	Type
PK-TOOL04	1 pc.	1/2"
PK-TOOL05	1 pc.	3/4"
PK-TOOL06	1 pc.	1"

Type: PK-TOOLBOX040506



Set wrenches for PK/SK fittings 1/2" - 1" threading
Juego de llaves para accesorios PK / SK 1/2" - 1" roscado
Conjunto de chaves para acessórios PK / SK 1/2" - 1" roscados

Article number	Packing	Type
PK-TOOL-BOX040506	1 pc.	

Type: PK-TOOLBOX



Empty plastic case for PK-TOOL04/05/06
Estuche de plástico vacío para PK-TOOL04/05/06
Caixa de plástico vazia para PK-TOOL04/05/06

Article number	pc	Type
PK-TOOLBOX	1 pc.	

Characteristics PK-TOOL / Características PK-TOOL / Características PK-TOOL

- ▶ Light weight ratchet key / Llave de carraca ligera / Chave de catraca leve
- ▶ Full grip around fitting profile / Agarre completo alrededor del perfil del accesorio / aderência total em torno do perfil de encaixe
- ▶ Plastic body stays intact, even when applying extreme torque / El cuerpo de plástico se mantiene intacto, incluso cuando se aplica un par de apriete extremo / O corpo plástico permanece intacto, mesmo quando se aplica um torque extremo
- ▶ Key works as well in clock- as counterclockwise direction / La llave funciona tanto en sentido horario como antihorario / A chave funciona tão bem no sentido dos ponteiros do relógio como no sentido contrário ao dos ponteiros do relógio
- ▶ Maximum torque transition / Par de apriete máximo de transición / Transição de torque máximo
- ▶ Size indication on handle / Indicación de tamaño en el mango / Indicação do tamanho no cabo
- ▶ Chromed handle / Mango cromado / Punho cromado
- ▶ Key gripping jaws in anodized aluminum / Mordazas de agarre de la llave en aluminio anodizado / Mandíbulas de aperto de chave em alumínio anodizado
- ▶ Possibility to grip around mounted fittings due to specific closing mechanism / Posibilidad de agarre alrededor de los accesorios montados gracias a un mecanismo de cierre específico / Possibilidade de agarrar os acessórios montados devido ao mecanismo de fecho específico







Type: BCLIP



Clip-it clip for Henco pipes, single
 Abrazadera simple para tubos Henco
 Abrazadera simple para tubos Henco

Article number	Box	Type
BCLIP-16	100 pc.	Ø16
BCLIP-1820	100 pc.	Ø18 - 20
BCLIP-26	100 pc.	Ø26
BCLIP-32 *	100 pc.	Ø32
BCLIP-40 *	100 pc.	Ø40
BCLIP-50 *	50 pc.	Ø50

* TILL EXHAUSTION OF STOCK

Type: JCLIP



J-clip pipe clips, single
 Abrazadera simple J-clip ø16- ø32, 70mm
 Abraçadeira simples J-clip ø16- ø32, 70mm

Article number	Box	Type
JCLIP-1632	200 pc.	Ø16-32, 70 mm

Type: JCLIP L



J-clip pipe clips, single
 Abrazadera simple J-clip ø32, 97mm
 Abraçadeira simples J-clip ø32, 97mm

Article number	Box	Type
JCLIP-1632L	200 pc.	Ø16-32, 97 mm

Type: JCLIP DOUBLE



N-clip pipe clips, double
 Abrazaderas de tubo doble N-clip
 Abraçadeira upla N-clip

Article number	Box	Type
JCLIP-1632D	200 pc.	Ø16-32, 70 mm

Type: JCLIP DOUBLE L



N-clip pipe clips, double
 Abrazaderas de tubo doble N-clip
 Abraçadeira upla N-clip

Article number	Box	Type
JCLIP-1632DL	200 pc.	Ø16-32, 97 mm

Type: PIPEPLUG



Protection cap for pipe
 Tapón protección para tubo
 Tapón protección para tubo

Article number	Bag / Box	Type
PIPEPLUG16	100 pc. / 700 pc.	Ø 16
PIPEPLUG20	100 pc. / 500 pc.	Ø 20
PIPEPLUG26	100 pc. / 500 pc.	Ø 26



1 **Type: PLP-P-PK**



Galvanised bracket for backplate elbow
Abrazadera inoxidable para codo con soporte
Abraçadeira aço inox para Joelho com suporte

Article number	Bag / Box	Type
PLP-P-PK	1 pc. / 30 pc.	

Interaxis 153mm

2 **Type: PLF-P-PK**



Galvanised bracket flat for backplate elbow
Abrazadera inoxidable plana para codo con soporte
Abraçadeira aço inox plana para Joelho com suporte

Article number	Bag / Box	Type
PLF-P-PK	1 pc. / 80 pc.	

Interaxis 120mm and 153mm

3 **Type: TESTPLUG**



Test cap for pipe
Tapón de prueba de presión para tubo Henco
Tampão de teste para tubo Henco

Article number	Bag / Box	Type
TESTPLUG16	20 pc. / 4000 pc.	
TESTPLUG20	20 pc. / 2000 pc.	
TESTPLUG26	20 pc. / 1000 pc.	

4 **Type: AK-EK**



Adapter from EK 3/4" to flat sealing
Adaptador eurocono 3/4" para junta plana
Adaptador Eurocone 3/4" para junta plana

Article number	Bag / Box	Type
AK-EK05VD	50 pc. / 1000 pc.	

5 **Type: REPAIR TAPE**



Mounting/Repair tape for insulated pipes
Cinta de montaje/reparación para tuberías aisladas
Montagem/Reparação de fita adesiva para tubos isolados

Article number	Bag / Box	Type
BDB33M	1 pc.	33 x 50mm
BDR33M	1 pc.	33 x 50mm

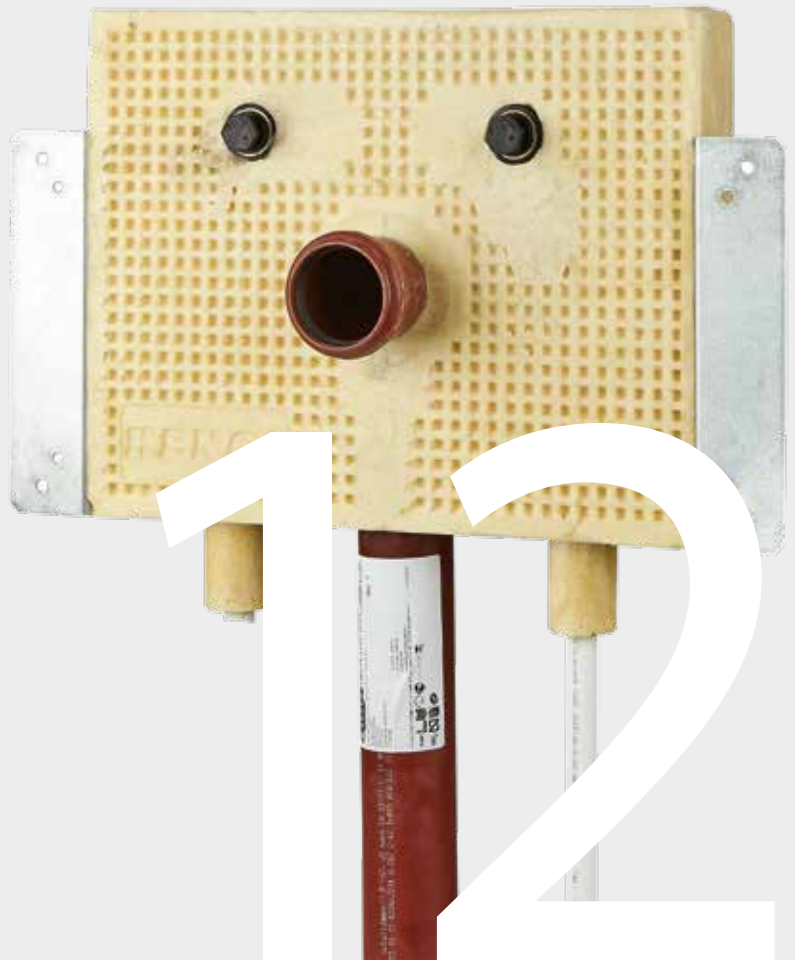

1 2

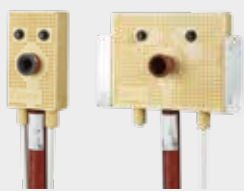

1 **Type: HBOX-GBD**

Bath- and Shower connection, Synthetic - Drywall
 Conexión para bañera y ducha, Sintético - Drywall
 Conexión para bañera y ducha, Sintético - Drywall

Article number	Type
HBOX-GBD1604	16 X 1/2"
HBOX-GBD2004	20 X 1/2"

2
3
4
5 **Type: HBOX-GBD-3P (CW617)**

Bath- and Shower connection, double backplate - Drywall
 Conexión para bañera y ducha, con doble placa de fondo - Drywall
 Ligaçao para banho e duche, placa traseira dupla - Drywall

Article number	Type
HBOX-GBD3P16	16 X 1/2"
HBOX-GBD3P20	20 X 1/2"

6
7
8 **Type: HBOX-GWM**

Washing machine connection, Synthetic - Drywall
 Conexión para lavadora, Sintético - Drywall
 Ligaçao para máquina de lavar roupa, Sintético - Drywall

Article number	Type
HBOX-GWM1604	16 X 1/2"

9
10
11
12 **Type: HBOX-GWM-3P (CW617)**

Washing machine connection, double backplate - Drywall
 Conexión para lavadora, doble placa de fondo - Drywall
 Ligaçao da máquina de lavar roupa, placa traseira dupla - Drywall

Article number	Type
HBOX-GWM3P20	20 X 1/2"

Type: HBOX-GSP

Sink connection, Synthetic - Drywall
 Conexión para fregadero, Sintético - Drywall
 Ligaçao de afundamento, Sintético - Drywall

Article number	Type
HBOX-GSP1604	16 X 1/2"

Type: HBOX-GSP-3P (CW617)

Sink connection, double backplate - Drywall
 Conexión para fregadero, placa trasera doble - Drywall
 Sink connection, double backplate - Drywall

Article number	Type
HBOX-GSP3P16	16 X 1/2"

Type: HBOX-GWT

Washbasin connection, Synthetic - Drywall
 Conexión para lavabo, Sintético - Drywall
 Ligaçao de lavatório, Sintético - Drywall

Article number	Type
HBOX-GWT16	16 X 1/2"

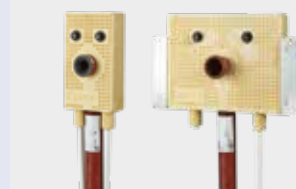

Type: HBOX-GWT-3P (CW617)

Washbasin connection, double backplate - Drywall
Conexión para lavabo, doble placa de fondo - Drywall
Ligação de lavatório, placa traseira dupla - Drywall

Article number	Type
HBOX-GWT3P16	16 X 1/2"

Type: HBOX-GR

Radiator connection - Drywall
Conexión para radiador - Drywall
Ligação do radiador - Drywall

Article number	Type
HBOX-GR1616	16 X 16

Type: HBOX-MSP

Sink connection, Synthetic - Masonry
Conexión para fregadero, Sintético - Albañilería
Ligação para banho e duche, Sintético - Alvenaria

Article number	Type
HBOX-MSP1604	16 X 1/2"

Type: HBOX-MBD

Bath- and Shower connection, Synthetic- Masonry
Conexión para baño y ducha, Sintético - Albañilería
Ligação para banho e duche, Sintético - Alvenaria

Article number	Type
HBOX-MBD1604	16 X 1/2"
HBOX-MBD2004	20 X 1/2"

Type: HBOX-MWM

Washing machine connection, Synthetic - Masonry
Conexión para lavadora, Sintético - Albañilería
Conexión para lavadora, Sintético - Mampostería

Article number	Type
HBOX-MWM1604	16 X 1/2"

Type: HBOX-MWT-3P (CW617)

Washbasin connection, double backplate - Masonry
Conexión para lavabo, doble placa trasera - Albañilería
Ligação de lavatório, placa traseira dupla - Alvenaria

Article number	Type
HBOX-MWT3P16	16 X 1/2"

1

2

3

4

5

6

7

8

9

10

11

12

CERTIFICATES - CERTIFICADOS - CERTIFICADOS





GERMANY



AUSTRIA



FRANCE



THE NETHERLANDS

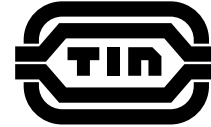

POLAND



DENMARK



ITALY



RUSSIA



SLOVAKIA



ATG SYSTEM CERTIFICATE BELGIUM



NORWAY



FINLAND



HUNGARY



ENGLAND



SWEDEN



USA



ESTONIA



SPAIN



CZECH REPUBLIC



SOUTH AFRICA

INDEX

Article number	Page	Article number	Page	Article number	Page	Article number	Page
03-160212	8	100-014MBLACK	10	10PK-322032	27	11PG-201616	85
03-180214	8	100-014MR	10	10PK-322632	27	11PK-161414	28
03-200216	8	100-016MB	10	10PK-401640	27	11PK-181616	28
03-260320	8	100-016MBLACK	10	10PK-402040	27	11PK-201616	28
03-320326	8	100-016MR	10	10PK-402640	27	11PK-201818	28
03-403533	8	100-018MB	10	10PK-403240	27	11PK-202016	28
03-504042	8	100-018MR	10	10PK-502050	27	11PK-261616	28
03-634554	8	100-020MB	10	10PK-502650	27	11PK-261620	28
03-R160212	13	100-020MR	10	10PK-503250	27	11PK-262016	28
03-R200216	13	100-121688	7	10PK-504050	27	11PK-262020	28
03-R260320	13	100-140210	7	10PK-632663	27	11PK-262616	28
04-160212	8	100-160212	7	10PK-633263	27	11PK-262620	28
04-200216	8	100-180214	7	10PK-634063	27	11PK-322026	28
04-260320	8	100-200216	7	10PK-635063	27	11PK-322626	28
04-320326	8	100-F16R-WZ	16	10PK-753275	27	11PK-402032	28
04-403533	8	100-F20R-WZ	16	10PK-754075	27	11PK-402632	28
04-504042	8	100-ISO4-14-BL	8	10PK-755075	27	11PK-403232	28
04-634554	8	100-ISO4-14-RO	8	10PK-756375	27	11PK-404026	28
04-R160212	13	100-ISO4-16-BL	8	10PK-903290	27	11PK-404032	28
04-R200216	13	100-ISO4-16-RO	8	10PK-904090	27	11PK-502040	28
04-R260320	13	100-ISO4-20-BL	8	10PK-905090	27	11PK-502640	28
05-160212	8	100-ISO4-20-RO	8	10PK-906390	27	11PK-503240	28
05-160212-GAS	20	100-ISO4-R16-BL	14	10PK-907590	27	11PK-504040	28
05-180214	8	100-ISO4-R16-RO	14	10PKG-201620	47	11PK-753232	28
05-200216	8	100-MB	19	10PKG-261626	47	11PK-753240	28
05-200216-GAS	20	100-MBLACK	19	10PKG-262026	47	11PK-753250	28
05-260320	8	100-MG16	19	10PKG-321632	47	11PK-753263	28
05-260320-GAS	20	100-MR	19	10PKG-322032	47	11PK-753275	28
05-320326	8	100-R160212	13	10PKG-322632	47	11PK-754040	28
05-320326-GAS	20	100-R16MB	16	10PKG-401640	47	11PK-754050	28
05-320326-SPR	21	100-R16MBLACK	16	10PKG-402040	47	11PK-754063	28
05-403533	8	100-R16MR	16	10PKG-402640	47	11PK-755050	28
05-403533-GAS	20	100-R180214	13	10PKG-403240	47	11PK-755063	28
05-403533-SPR	21	100-R200216	13	10PKS-402640	51	11PK-756363	28
05-504042	8	100-R20MB	16	10PKS-403240	51	11PK-903232	28
05-504042-SPR	21	100-R20MR	16	10PKS-503250	51	11PK-903240	28
05-634554	8	10P-181618	74	10PKS-504050	51	11PK-903250	28
05-634554-SPR	21	10P-201620	74	10PKS-633263	51	11PK-903263	28
05-756063	8	10P-261626	74	10PKS-634063	51	11PK-903275	28
05-907076	8	10P-262026	74	10PKS-635063	51	11PK-903290	28
05-R160212	13	10P-321632	74	10PKW-201620	40	11PK-904040	28
05-R200216	13	10P-322032	74	10PKW-261626	40	11PK-904050	28
05-R260320	13	10P-322632	74	10PKW-262026	40	11PK-904063	28
1-1604-S	89	10PG-262026	85	10PKW-321632	40	11PK-904075	28
1-1604ZA	89	10PK-161416	27	10PKW-322032	40	11PK-905050	28
1-1605-S	89	10PK-16JG1016	27	10PKW-322632	40	11PK-905063	28
1-1804-S	89	10PK-181418	27	10SK-201620	65	11PK-905075	28
1-1805	89	10PK-181618	27	10SK-261626	65	11PK-906363	28
1-2004-S	89	10PK-201420	27	10SK-262026	65	11PK-906375	28
1-2004-ZS	89	10PK-201620	27	11P-201616	74	11PK-907575	28
1-2005-S	89	10PK-201820	27	11P-202016	74	11PKG-201616	47
1-2605-S	89	10PK-20JG1020	27	11P-261620	74	11PKG-202016	47
1-2606-S	89	10PK-261626	27	11P-262020	74	11PKG-261620	47
1-3206-S	89	10PK-261826	27	11P-262616	74	11PKG-262016	47
10-160212-KB	7	10PK-262026	27	11P-262620	74	11PKG-262020	47
10-1604SN	91	10PK-321632	27	11P-322026	74	11PKG-262616	47
10-R160212-KB	13	10PK-321832	27	11P-322626	74	11PKG-262620	47

Article number	Page	Article number	Page	Article number	Page	Article number	Page
11PKG-322026	47	12SK-202620	66	13PK-901490	29	13PKW-320632	41
11PKG-322626	47	13-1415-2	91	13PKG-160416BP	48	13PKW-320632-N	41
11PKG-402032	47	13-1615A-2	91	13PKG-200420BP	48	13PKW-320632-X	41
11PKG-402632	47	13-1615HA-2	91	13PKG-200520	48	13SK-160416BP	66
11PKG-403232	47	13-2022HA-2	91	13PKG-260420BP	48	13SK-200420BP	66
11PKG-404026	47	13-2628H-2	91	13PKG-260426BP	48	13SK-200520	66
11PKG-404032	47	13-V2622H-2	91	13PKG-260526	48	13SK-260420BP	66
11PKS-403232	51	13P-160416	75	13PKG-320532	48	13SK-260426BP	66
11PKS-404032	51	13P-200420	75	13PKG-320632	48	13SK-260526	66
11PKS-503240	51	13P-200520	75	13PKG-320732	48	14P-160416	75
11PKS-504040	51	13P-260426	75	13PKG-400640	48	14P-200420	75
11PKW-201616	40	13P-260526	75	13PKG-400740	48	14P-200520	75
11PKW-202016	40	13P-320532	75	13PKS-260426	52	14P-260426	75
11PKW-261616	40	13PG-200420	85	13PKS-260426-N	52	14PK-160416	30
11PKW-261620	40	13PG-260426	85	13PKS-320432	52	14PK-180418	30
11PKW-262016	40	13PG-260526	85	13PKS-320432-N	52	14PK-200420	30
11PKW-262020	40	13PK-160416-X	30	13PKS-320532	52	14PK-200520	30
11PKW-262616	40	13PK-160416BP	29	13PKS-320532-N	52	14PK-260426	30
11PKW-262620	40	13PK-180418-X	30	13PKS-320632	52	14PK-260526	30
11PKW-322026	40	13PK-180418BP	29	13PKS-320632-N	52	14PK-260626	30
11PKW-322626	40	13PK-200420-X	30	13PKS-320732	52	14PK-320532	30
11SK-201616	66	13PK-200420BP	29	13PKS-320732-N	52	14PK-400640	30
11SK-202016	66	13PK-200520	29	13PKS-400440	52	14PK-400640-N	31
11SK-261620	66	13PK-200520-X	30	13PKS-400440-N	52	14PK-400740	30
11SK-262016	66	13PK-260420-X	30	13PKS-400640	52	14PK-400740-N	31
11SK-262020	66	13PK-260420BP	29	13PKS-400640-N	52	14PK-500850	30
11SK-262616	66	13PK-260426-X	30	13PKS-400740	52	14PK-500850-N	31
11SK-262620	66	13PK-260426BP	29	13PKS-400740-N	52	14PK-631063	30
120-PRT1620	18	13PK-260526	29	13PKS-500450	52	14PK-631063-N	31
12P-162016	75	13PK-260526-X	30	13PKS-500450-N	52	14PK-751075	30
12P-202620	75	13PK-320532	29	13PKS-500550	52	14PK-751275	30
12P-263226	75	13PK-320532-X	30	13PKS-500550-N	52	14PKG-160416	48
12PK-161816	29	13PK-320632	29	13PKS-500850	52	14PKG-200420	48
12PK-162016	29	13PK-320632-X	30	13PKS-500850-N	52	14PKG-260426	48
12PK-202620	29	13PK-320732	29	13PKS-630463	52	14PKG-260626	48
12PK-263226	29	13PK-320732-X	30	13PKS-630463-N	52	14PKS-320532	53
12PK-324032	29	13PK-400540	29	13PKS-631063	52	14PKS-320532-N	53
12PK-327532	29	13PK-400540-N	30	13PKS-631063-N	52	14PKS-400640	53
12PK-329032	29	13PK-400540-X	30	13PKW-160416	41	14PKS-400640-N	53
12PK-405040	29	13PK-400640	29	13PKW-160416-N	41	14PKS-400740	53
12PK-407540	29	13PK-400640-N	30	13PKW-160416-X	41	14PKS-400740-N	53
12PK-409040	29	13PK-400640-X	30	13PKW-200420	41	14PKS-500850	53
12PK-507550	29	13PK-400740	29	13PKW-200420-N	41	14PKS-500850-N	53
12PK-509050	29	13PK-400740-N	30	13PKW-200420-X	41	14PKS-631063	53
12PK-637563	29	13PK-400740-X	30	13PKW-200520	41	14PKS-631063-N	53
12PK-639063	29	13PK-500550	29	13PKW-200520-N	41	14PKW-160416-N	42
12PK-759075	29	13PK-500550-N	30	13PKW-200520-X	41	14PKW-200420-N	42
12PKG-162016	47	13PK-500550-X	30	13PKW-260426	41	14PKW-200520-N	42
12PKG-202620	47	13PK-500850	29	13PKW-260426-N	41	14SK-160416	66
12PKG-263226	47	13PK-500850-N	30	13PKW-260426-X	41	14SK-200420	66
12PKG-324032	47	13PK-500850-X	30	13PKW-260526	41	14SK-260426	66
12PKS-324032	52	13PK-631063	29	13PKW-260526-N	41	15-160212-KB	7
12PKS-405040	52	13PK-631063-N	30	13PKW-260526-X	41	15-R160212-KB	13
12PKW-162016	41	13PK-631063-X	30	13PKW-260526-X	41	15P-1414	75
12PKW-202620	41	13PK-750675	29	13PKW-320532	41	15P-1616	75
12PKW-263226	41	13PK-751075	29	13PKW-320532-N	41	15P-1818	75
12SK-162016	66	13PK-751275	29	13PKW-320532-X	41	15P-2020	75

INDEX

Article number	Page	Article number	Page	Article number	Page	Article number	Page
15P-2626	75	16PK-3226	32	17PG-2005	86	17PKW-3207	43
15P-3232	75	16PK-4026	32	17PG-2605	86	17PKW-3207-N	43
15PG-1616	86	16PK-4032	32	17PG-2606	86	17SK-1603	67
15PG-2020	86	16PK-5032	32	17PG-3206	86	17SK-1604	67
15PG-2626	86	16PK-5040	32	17PK-1404	33	17SK-2004	67
15PG-3232	86	16PK-6340	32	17PK-1604	33	17SK-2005	67
15PK-1414	31	16PK-6350	32	17PK-1804	33	17SK-2605	67
15PK-1616	31	16PK-7532	32	17PK-1805	33	17SK-2606	67
15PK-1818	31	16PK-7540	32	17PK-2004	33	17SKS-2004	68
15PK-2020	31	16PK-7550	32	17PK-2005	33	17SKS-2004	97
15PK-2626	31	16PK-7563	32	17PK-2605	33	17SKS-2005	68
15PK-3232	31	16PK-9032	32	17PK-2606	33	17SKS-2005	97
15PK-4040	31	16PK-9040	32	17PK-3206	33	17SKS-2604	68
15PK-5050	31	16PK-9050	32	17PK-3207	33	17SKS-2604	97
15PK-6363	31	16PK-9063	32	17PK-4006	33	17SKS-2605	68
15PK-7575	31	16PK-9075	32	17PK-4006-N	33	17SKS-2605	97
15PK-9090	31	16PKG-2016	49	17PK-4007	33	17VBS-2005	104
15PKG-1616	48	16PKG-2616	49	17PK-4007-N	33	17VBS-2605	104
15PKG-2020	48	16PKG-2620	49	17PK-5008	33	17VBS-2606	104
15PKG-2626	48	16PKG-3216	49	17PK-5008-N	33	18EK05-03	98
15PKG-3232	48	16PKG-3220	49	17PK-6310	33	18HNA-06	60
15PKG-4040	48	16PKG-3226	49	17PK-6310-N	33	18HNA-06-N	61
15PKS-3232	53	16PKG-4026	49	17PK-7510	33	18HNA-10	60
15PKS-4040	53	16PKG-4032	49	17PK-7512	33	18HNA-10-N	61
15PKS-5050	53	16PKS-4032	53	17PKG-1604	49	18HNA-12	60
15PKS-6363	53	16PKS-5032	53	17PKG-2004	49	18HNA-12-N	61
15PKW-1616	42	16PKS-5040	53	17PKG-2005	49	18HNB-14	60
15PKW-2020	42	16PKS-6340	53	17PKG-2605	49	18HNB-14-N	61
15PKW-2626	42	16PKS-6350	53	17PKG-2606	49	18P-1604	76
15PKW-3232	42	16PKW-2016	42	17PKG-3206	49	18P-1804	76
15SK-1616	67	16PKW-2616	42	17PKG-3207	49	18P-2004	76
15SK-2020	67	16PKW-2620	42	17PKG-4006	49	18P-2005	76
15SK-2626	67	16PKW-3216	42	17PKG-4007	49	18P-2605	76
16HNBA	59	16PKW-3220	42	17PKS-3206	54	18P-2606	76
16P-1614	76	16PKW-3226	42	17PKS-3206-N	54	18P-3206	76
16P-1816	76	16SK-2016	67	17PKS-3207	54	18P-3207	76
16P-2016	76	16SK-2616	67	17PKS-3207-N	54	18PG-1604	87
16P-2018	76	16SK-2620	67	17PKS-4006	54	18PG-2004	87
16P-2616	76	17HNA-10	60	17PKS-4006-N	54	18PG-2005	87
16P-2620	76	17HNA-10-N	60	17PKS-4007	54	18PG-2605	87
16P-3216	76	17HNA-12	60	17PKS-4007-N	54	18PG-2606	87
16P-3220	76	17HNA-12-N	60	17PKS-5008	54	18PG-3206	87
16P-3226	76	17P-1603	76	17PKS-5008-N	54	18PK-1404	34
16PG-2016	86	17P-1603DZR	76	17PKS-6310	54	18PK-1604	34
16PG-2620	86	17P-1604	76	17PKS-6310-N	54	18PK-1604-X	34
16PG-3226	86	17P-1604DZR	76	17PKW-1604	43	18PK-1804	34
16PK-1614	32	17P-1605	76	17PKW-1604-N	43	18PK-1804-X	34
16PK-1814	32	17P-1804	76	17PKW-2004	43	18PK-1805	34
16PK-1816	32	17P-1805	76	17PKW-2004-N	43	18PK-1805-X	34
16PK-2014	32	17P-2004	76	17PKW-2005	43	18PK-2004	34
16PK-2016	32	17P-2005	76	17PKW-2005-N	43	18PK-2004-X	34
16PK-2018	32	17P-2605	76	17PKW-2605	43	18PK-2005	34
16PK-2616	32	17P-2606	76	17PKW-2605-N	43	18PK-2005-X	34
16PK-2618	32	17P-3206	76	17PKW-2606	43	18PK-2605	34
16PK-2620	32	17P-3207	76	17PKW-2606-N	43	18PK-2605-X	34
16PK-3216	32	17PG-1604	86	17PKW-3206	43	18PK-2606	34
16PK-3220	32	17PG-2004	86	17PKW-3206-N	43	18PK-2606-X	34

Article number	Page	Article number	Page	Article number	Page	Article number	Page
18PK-3206	34	18PKW-2606-X	43	1PK-2626	23	25-032GASMG	20
18PK-3206-X	34	18PKW-3206	43	1PK-3232	23	25-032MB	10
18PK-3207	34	18PKW-3206-N	44	1PK-4040	23	25-032MR	10
18PK-3207-X	34	18PKW-3206-X	43	1PK-5050	23	25-160212-GAS	20
18PK-4006	34	18PKW-3207	43	1PK-6363	23	25-160212-KB	7
18PK-4006-N	34	18PKW-3207-N	44	1PK-7575	23	25-200216	7
18PK-4006-X	34	18PKW-3207-X	43	1PK-9090	23	25-200216-GAS	20
18PK-4007	34	18SK-1604	67	1PKG-1616	45	25-200216-KB	7
18PK-4007-N	34	18SK-2004	67	1PKG-2020	45	25-ISO13-32-BL	9
18PK-4007-X	34	18SK-2005	67	1PKG-2626	45	25-ISO13-32-RO	9
18PK-5008	34	18SK-2605	67	1PKG-3232	45	25-ISO20-R26-BL	15
18PK-5008-N	34	18SK-2606	67	1PKG-4040	45	25-ISO20-R26-RO	15
18PK-5008-X	34	18SKS-2004	68	1PKS-3232	50	25-ISO4-26-BL	8
18PK-6310	34	18SKS-2004	97	1PKS-4040	50	25-ISO4-26-RO	8
18PK-6310-N	34	18SKS-2005	68	1PKS-5050	50	25-ISO4-32-BL	8
18PK-6310-X	34	18SKS-2005	97	1PKS-6363	50	25-ISO4-32-RO	8
18PK-7506	34	18SKS-2604	68	1PKW-1616	37	25-ISO4-R16-BL	14
18PK-7510	34	18SKS-2604	97	1PKW-2020	37	25-ISO4-R16-RO	14
18PK-7512	34	18SKS-2605	68	1PKW-2626	37	25-ISO4-R26-BL	14
18PK-9014	34	18SKS-2605	97	1PKW-3232	37	25-ISO4-R26-RO	14
18PKG-1604	49	19P-1405	77	1SK-1616	64	25-ISO9-26-BL	9
18PKG-2004	49	19P-1605	62	1SK-2020	64	25-ISO9-26-RO	9
18PKG-2005	49	19P-1605	77	1SK-2626	64	25-ISO9-32-BL	9
18PKG-2605	49	19P-1805	77	2-1616-S	89	25-ISO9-32-RO	9
18PKG-2606	49	19P-2005	62	2-2020-S	89	25-ISO9-R26-BL	14
18PKG-3206	49	19P-2005	77	200-121688	7	25-ISO9-R26-RO	14
18PKG-3207	49	19PK-1605	35	200-140210	7	25-MB32	19
18PKG-4006	49	19PK-1605	62	200-160212	7	25-MG32	19
18PKG-4007	49	19PK-2005	35	200-180214	7	25-MR32	19
18PKS-3204	54	19PK-2005	62	200-F16R-WZ	16	25-R160212-KB	13
18PKS-3204-N	54	19PKW-1605	44	200-PRT1620	18	25-R16MB	16
18PKS-3206	54	19PKW-2005	44	200-PXC1620	17	25-R16MR	16
18PKS-3206-N	54	19SK-1505	68	200-PXC1720	17	25-R20MB	16
18PKS-3207	54	19SK-1505	96	200-PXC2020	17	25-R20MBLACK	16
18PKS-3207-N	54	19SK-1605	62	200-R160212	13	25-R20MR	16
18PKS-4006	54	19SK-1605	68	200-R180214	13	25P-1604	77
18PKS-4006-N	54	19SK-1605	96	24-1615-S	91	26P-1604	77
18PKS-4007	54	19SK-2005	62	24-2022	91	26P-1605	77
18PKS-4007-N	54	19SK-2005	68	24-2622	91	26P-16Z03	77
18PKS-5008	54	19SK-2005	96	240-PRT1820	18	26P-16Z04	77
18PKS-5008-N	54	1HNA	59	240-PXC1820	17	26P-16Z05	77
18PKS-6310	54	1HNB	59	24P-1604	77	26P-2004	77
18PKS-6310-N	54	1P-1616	72	24P-2004	77	26P-2005	77
18PKW-1604	43	1P-1818	72	25-014MB	10	26P-20Z04	77
18PKW-1604-N	44	1P-2020	72	25-014MR	10	26P-20Z05	77
18PKW-1604-X	43	1P-2626	72	25-016GASMG	20	26P-2605	77
18PKW-2004	43	1P-3232	72	25-016MB	10	26P-2606	77
18PKW-2004-N	44	1PG-1616	84	25-016MB-KB	11	26P-26Z05	77
18PKW-2004-X	43	1PG-2020	84	25-016MR	10	26P-26Z06	77
18PKW-2005	43	1PG-2626	84	25-016MR-KB	11	26P-3206	77
18PKW-2005-N	44	1PG-3232	84	25-020GASMG	20	26P-32Z06	77
18PKW-2005-X	43	1PK-1414	23	25-020MB	10	26P-32Z07	77
18PKW-2605	43	1PK-1616	23	25-020MBLACK	10	26PK-4008	35
18PKW-2605-N	44	1PK-16JG10	23	25-020MR	10	26PK-5010	35
18PKW-2605-X	43	1PK-1818	23	25-026GASMG	20	26PK-6312	35
18PKW-2606	43	1PK-2020	23	25-026MB	10	26PKW-1605	44
18PKW-2606-N	44	1PK-20JG10	23	25-026MR	10	26PKW-2005	44

INDEX

Article number	Page	Article number	Page	Article number	Page	Article number	Page
26SK-1605	68	2PK-2004BP	23	35P-2022P	80	44P-1604	82
26SK-1605	96	2PK-2005	23	35P-3228P	80	45P-1604	82
26SK-2005	68	2PK-2005-X	23	36P-1612P	80	4P-1604	73
26SK-2005	96	2PK-2605	23	36P-1614P	80	4P-2004	73
27HNA	59	2PK-2605-X	23	36P-1615P	80	5-1604-S	90
27HNB	59	2PKG-1603	45	36P-1616P	80	5-1804	90
27P-2626	78	2PKG-1604BP	45	36P-2015P	80	5-2005-S	90
27P-3232	78	2PKG-1604KBP	45	36P-2018P	80	5-2606-S	90
27PK-2626	35	2PKG-2004BP	45	36P-2022P	80	50-014MB	10
27PK-3232	35	2PKG-2005	45	36P-2620P	80	50-014MR	10
27PK-4040	35	2PKG-2605	45	36P-2622P	80	50-016GASMG	20
27PK-5050	35	2PKW-1604	37	36P-2628P	80	50-016MB	10
27PK-6363	35	2PKW-1604-N	37	36P-3228P	80	50-016MBLACK	10
27PK-7575	35	2PKW-1604-X	38	36PG-1615P	87	50-016MR	10
27PK-9090	35	2PKW-1604K	37	36PG-2015P	87	50-018MB	10
27PKG-4040	49	2PKW-1604K-N	38	36PG-2022P	87	50-018MR	10
27PKS-3232	55	2PKW-1604K-X	37	36PG-2615P	87	50-020GASMG	20
27PKS-4040	55	2PKW-2004	37	36PG-2622P	87	50-020MB	10
27PKS-5050	55	2PKW-2004-N	37	37P-1412L	81	50-020MBLACK	10
27PKS-6363	55	2PKW-2004-X	37	37P-1612L	81	50-020MR	10
27PKW-2626	44	2PKW-2005	37	37P-1615L	81	50-026GASMG	20
27PKW-3232	44	2PKW-2005-N	37	39P-160450	81	50-026MB	10
28-201620	91	2PKW-2005-X	37	3EK-050405	94	50-026MBLACK	10
28P-14041604-1	78	2PKW-2605	37	3P-160416	72	50-026MR	10
28P-16041604-1	78	2PKW-2605-N	37	3P-160416VK	72	50-160212	7
28PF-16041604	78	2PKW-2605-X	37	3P-200420	72	50-160212-GAS	20
28PF-20042004	78	2S-1604K	64	3P-200420VK	72	50-200216	7
28PK-04	36	2SK-1604BP	64	3P-260426VK	72	50-200216-GAS	20
28PV-16031603-1	78	2SK-2004BP	64	3PK-160416-X	24	50-260320	7
28PV-16041604-1	78	2SK-2005	64	3PK-160416BP	24	50-260320-GAS	20
29P-1612-CS	79	2SK-2605	64	3PK-200420-X	24	50-260320-SPR	21
29P-1615-CS	79	3-1604-S	89	3PK-200420BP	24	50-320326	7
29P-2018-CS	79	3-1804-S	89	3PKW-160416	38	50-320326-GAS	20
29P-2022-CS	79	3-2004-S	89	3PKW-160416-N	38	50-320326-SPR	21
29P-2622-CS	79	3-2005-S	89	3PKW-160416-X	38	50-COMBI16	10
2C-0404	94	3-2605-S	89	3PKW-200420	38	50-COMBI16R	16
2P-1404K	72	3-2606-S	89	3PKW-200420-N	38	50-ISO13-16-BL	9
2P-1604	72	30P-1614S	79	3PKW-200420-X	38	50-ISO13-16-RO	9
2P-1604K	72	30P-1615S-2	79	3SK-160416BP	64	50-ISO13-18-BL	9
2P-1804	72	30P-2022S	79	3SK-200420BP	64	50-ISO13-20-BL	9
2P-2004	72	30P-2622S	79	4-1616-S	89	50-ISO13-20-RO	9
2P-2005	72	30PG-1615S-2	87	4-2020-S	89	50-ISO13-26-BL	9
2P-2605	72	30PG-2022S	87	4-2626-S	89	50-ISO13-26-RO	9
2PG-1604	84	30PG-2622S	87	400-F20R-WZ	16	50-ISO13-R16-BL	14
2PG-1604K	84	31P-161616	79	40P-1615S	81	50-ISO13-R16-RO	14
2PG-2004	84	31P-201616	79	40P-2022S	81	50-ISO13-R20-BL	14
2PG-2005	84	31P-201620	79	40P-2622S	81	50-ISO13-R20-RO	14
2PG-2605	84	31P-202020	79	41P-16	81	50-ISO13-R26-BL	14
2PK-1404-X	23	33P-1605	62	41P-20	81	50-ISO13-R26-RO	14
2PK-1404BP	23	33P-1605	79	41P-26	81	50-ISO20-R16-BL	15
2PK-1603	23	34P-1604	80	41S-20	109	50-ISO20-R16-RO	15
2PK-1604-X	23	34P-1605-CS	80	41S-26	109	50-ISO20-R20-BL	15
2PK-1604BP	23	34P-2004-CS	80	41SKS-20	109	50-ISO20-R20-RO	15
2PK-1604KBP	24	34P-2005-CS	80	41SKS-26	109	50-ISO4-16-BL	8
2PK-1804-X	23	34P-2605-CS	80	42P-161615	82	50-ISO4-16-RO	8
2PK-1804BP	23	34P-3206	80	42P-202019	82	50-ISO4-18-BL	8
2PK-2004-X	23	35P-1615P	80	43P-161516	82	50-ISO4-18-RO	8

Article number	Page	Article number	Page	Article number	Page	Article number	Page
50-ISO4-20-BL	8	500-F16R-WZ	16	5PKS-5007	50	6PK-5007	25
50-ISO4-20-RO	8	500-R160212D	13	5PKS-5007-N	50	6PK-5007-N	26
50-ISO4-26-BL	8	50P-3206	55	5PKS-5008	50	6PK-5007-X	26
50-ISO4-26-RO	8	50P-320604	55	5PKS-5008-N	50	6PK-5008	25
50-ISO4-32-BL	8	50P-320605	55	5PKS-6310	50	6PK-5008-N	26
50-ISO4-32-RO	8	50P43-320604	55	5PKS-6310-N	50	6PK-5008-X	26
50-ISO4-COMBI16	9	52P16	82	5PKW-1604	39	6PK-6310	25
50-ISO4-COMBI16R	15	52P20	82	5PKW-1604-N	39	6PK-6310-N	26
50-ISO4-R16-BL	14	52P26	82	5PKW-2004	39	6PK-6310-X	26
50-ISO4-R16-RO	14	52P32	82	5PKW-2004-N	39	6PK-7506	25
50-ISO4-R18-BL	14	52PS32	55	5PKW-2005	39	6PK-7510	25
50-ISO4-R18-RO	14	53PK40	36	5PKW-2005-N	39	6PK-7512	25
50-ISO4-R20-BL	14	53PK50	36	5PKW-2605	39	6PK-9014	25
50-ISO4-R20-RO	14	53PK63	36	5PKW-2605-N	39	6PKG-1604BP	46
50-ISO4-R26-BL	14	53PKS40	55	5PKW-3206	39	6PKG-2004BP	46
50-ISO4-R26-RO	14	53PKS50	55	5PKW-3206-N	39	6PKG-2005	46
50-ISO9-14-BL	9	53PKS63	55	5SK-1604	65	6PKG-2605	46
50-ISO9-14-RO	9	5P-1603	73	5SK-2004	65	6PKG-3206	46
50-ISO9-16-BL	9	5P-1603DZR	73	5SK-2005	65	6PKG-4007	46
50-ISO9-16-RO	9	5P-1604	73	5SK-2605	65	6PKS-3204	50
50-ISO9-18-BL	9	5P-1604DZR	73	6-1604-S	90	6PKS-3204-N	51
50-ISO9-18-RO	9	5P-1804	73	6-1804	90	6PKS-3206	50
50-ISO9-20-BL	9	5P-2004	73	6-2005-S	90	6PKS-3206-N	51
50-ISO9-20-RO	9	5P-2005	73	600-PRT1620	18	6PKS-4004	50
50-ISO9-26-BL	9	5P-2605	73	600-PRT1720	18	6PKS-4004-N	51
50-ISO9-26-RO	9	5P-3206	73	600-PRT1820	18	6PKS-4007	50
50-ISO9-32-BL	9	5PG-1604	84	600-PRT2020	18	6PKS-4007-N	51
50-ISO9-32-RO	9	5PG-2004	84	600-PXC1620	17	6PKS-5004	50
50-ISO9-R16-BL	14	5PG-2005	84	600-PXC1720	17	6PKS-5004-N	51
50-ISO9-R16-RO	14	5PG-2605	84	600-PXC2020	17	6PKS-5007	50
50-ISO9-R18-BL	14	5PK-1404	25	6P-1604	73	6PKS-5007-N	51
50-ISO9-R20-BL	14	5PK-1604	25	6P-1804	73	6PKS-5008	50
50-ISO9-R20-RO	14	5PK-1804	25	6P-2004	73	6PKS-5008-N	51
50-ISO9-R26-BL	14	5PK-2004	25	6P-2005	73	6PKS-6304	50
50-ISO9-R26-RO	14	5PK-2005	25	6P-2605	73	6PKS-6304-N	51
50-MB20	19	5PK-2605	25	6PG-1604	85	6PKS-6310	50
50-MB26	19	5PK-3206	25	6PG-2004	85	6PKS-6310-N	51
50-MBLACK20	19	5PK-4007	25	6PG-2005	85	6PKW-1603	39
50-MBLACK26	19	5PK-4007-N	25	6PG-2605	85	6PKW-1603-N	40
50-MG16	19	5PK-5007	25	6PK-1404-X	26	6PKW-1604	39
50-MG20	19	5PK-5007-N	25	6PK-1404BP	25	6PKW-1604-N	40
50-MG26	19	5PK-5008	25	6PK-1603	25	6PKW-1604-X	39
50-MR20	19	5PK-5008-N	25	6PK-1604-X	26	6PKW-2004	39
50-MR26	19	5PK-6310	25	6PK-1604BP	25	6PKW-2004-N	40
50-MXC1620	62	5PK-6310-N	25	6PK-1804-X	26	6PKW-2004-X	39
50-R160212	13	5PK-7510	25	6PK-1804BP	25	6PKW-2005	39
50-R16MB	16	5PK-7512	25	6PK-2004-X	26	6PKW-2005-N	40
50-R16MBLACK	16	5PKG-1604	46	6PK-2004BP	25	6PKW-2005-X	39
50-R16MR	16	5PKG-2004	46	6PK-2005	25	6PKW-2605	39
50-R18MB	16	5PKG-2005	46	6PK-2005-X	26	6PKW-2605-N	40
50-R18MR	16	5PKG-2605	46	6PK-2605	25	6PKW-2605-X	39
50-R20MB	16	5PKG-3206	46	6PK-2605-X	26	6PKW-3206	39
50-R20MR	16	5PKG-4007	46	6PK-3206	25	6PKW-3206-N	40
50-R260320	13	5PKS-3206	50	6PK-3206-X	26	6PKW-3206-X	39
50-R26MB	16	5PKS-3206-N	50	6PK-4007	25	6SK-1604BP	65
50-R26MR	16	5PKS-4007	50	6PK-4007-N	26	6SK-2004BP	65
500-160212D	7	5PKS-4007-N	50	6PK-4007-X	26	6SK-2005	65

INDEX

Article number	Page	Article number	Page	Article number	Page	Article number	Page
6SK-2605	65	AB1420	92	BE14	144	BE22M-MINI3	150
6VBS-2005	104	ABEK04	93	BE14H	146	BE22MMINI	151
6VBS-2605	104	AD-EKEK	93	BE14H	152	BE22V-MINI3	150
7-1604-S	90	AK-EK05VD	160	BE14H	153	BE26	144
7-2004-S	90	AN1420	93	BE14HC	146	BE26H	146
7P-1605	73	AT1420	93	BE14HC	152	BE26H	152
7P-1605K	73	BA-1288	138	BE14HC	153	BE26H	153
7P-1605L	73	BA-1410	138	BE14M	154	BE26MINI	150
8-161616-S	90	BA-1612	138	BE14MINI3	149	BE26MINI3	149
8-202020-S	90	BA-1814	138	BE15C	151	BE28C	151
8HNA-PK...	62	BA-2016	138	BE15HC	146	BE28HC	146
8HNA-PK32	59	BA-F41	109	BE15HC	152	BE28HC	152
8HNA-PK40	59	BAP-FFV1604	107	BE15HC	153	BE28HC	153
8HNA-PK50	59	BAP-FFV1605EK	107	BE15HM	147	BE28M-MINI3	150
8HNA-PK63	59	BAP-FFV1616	107	BE15HM	152	BE28V-MINI3	150
8HNA-PK75	59	BAP-FFV16Z05	107	BE15HM	154	BE32	144
8HNB-PK90	59	BAP-FFV1805	107	BE15M-MINI3	150	BE32H	146
8P-1604	74	BAP-FFV2005	107	BE15MMINI	151	BE32H	152
9-160416	90	BAP-FFV2005EK	107	BE15V-MINI3	150	BE32H	153
9-200520A	90	BAP-FFV2020	107	BE16	144	BE32MINI	150
9HNA	59	BAP-FFV20Z05	107	BE16H	146	BE32MINI3	149
9HNB	59	BAP-FFV2605	107	BE16H	152	BE40	144
9P-161616	74	BAP-FFV2605EK	107	BE16H	153	BE50	144
9P-181818	74	BAP-FFV2606	107	BE16HC	146	BE63	144
9P-202020	74	BAP-FFV2626	107	BE16HC	152	BI-1410	138
9P-262626	74	BAP-FFV26Z05	107	BE16HC	153	BI-1612	138
9P-323232	74	BAP-FFV26Z06	107	BE16M	154	BI-1612L	138
9PG-161616	85	BAP-FFV3207	107	BE16MINI	150	BI-1814	138
9PG-202020	85	BAP-FFV3232	107	BE16MINI3	149	BI-2016	138
9PG-323232	85	BAP-FFV32Z06	107	BE18	144	BI-2016L	138
9PK-141414	26	BAP-H1616	108	BE18C	151	BI-2620	138
9PK-161616	26	BAP-H2020	108	BE18H	146	BM-16	138
9PK-181818	26	BAP-H2626	108	BE18H	152	BM-16F	138
9PK-202020	26	BAP-H3232	108	BE18H	153	BM-18	138
9PK-262626	26	BAP-SV1610S	108	BE18HC	146	BM-20	138
9PK-323232	26	BCLIP-16	159	BE18HC	152	BM-20F	138
9PK-404040	26	BCLIP-1820	159	BE18HC	153	BM-26	138
9PK-505050	26	BCLIP-26	159	BE18HM	147	BP04	24
9PK-636363	26	BCLIP-32	159	BE18HM	152	CU-10ZONEK-230V	128
9PK-757575	26	BCLIP-40	159	BE18HM	154	CU-10ZONEK-24V	128
9PK-909090	26	BCLIP-50	159	BE18M	154	CU-12ZONE-RF	132
9PKG-161616	46	BDB33M	160	BE18M-MINI3	150	CU-6ZONE-230V	128
9PKG-202020	46	BDR33M	160	BE18V-MINI3	150	CU-6ZONE-24V	128
9PKG-262626	46	BE-BOX	147	BE20	144	CU-6ZONEK-230V	128
9PKG-323232	46	BE-MINI	151	BE20H	146	CU-6ZONEK-24V	128
9PKG-404040	46	BE-MINI3	149	BE20H	152	CU-6ZONEP-230V	128
9PKS-323232	51	BE-UNI	146	BE20H	153	CU-6ZONEP-24V	128
9PKS-404040	51	BE-UNISSET1	144	BE20M	154	CU-8ZONE-RF	132
9PKS-505050	51	BE-UNISSET2	145	BE20MINI	150	CU-8ZONEB-RF	132
9PKS-636363	51	BE-UNISSETMINI3	145	BE20MINI3	149	CU-ACT-230V	129
9PKW-161616	40	BE12HC	146	BE22C	151	CU-ACT-230V-PLUG	129
9PKW-202020	40	BE12HC	152	BE22HC	146	CU-ACT-230V-PLUG	134
9PKW-262626	40	BE12HC	153	BE22HC	152	CU-ACT-24V	129
9PKW-323232	40	BE12HM	147	BE22HC	153	CU-ACT-24V-PLUG	129
9SK-161616	65	BE12HM	152	BE22HM	147	CU-ACT-B230V	129
9SK-202020	65	BE12HM	154	BE22HM	152	CU-ANT	133
9SK-262626	65	BE12M-MINI3	150	BE22HM	154	CU-DINRAIL	128

Article number	Page	Article number	Page	Article number	Page	Article number	Page
CU-MONO-RF	132	HNA-STOP	61	N04	78	UFH-0405SLT01	125
CU-PLUGCABLE-15M	130	HNA-STOP	61	N05	78	UFH-0405SLT02	125
CU-PLUGCABLE-15M	134	HNA-STOP-E	61	N06	78	UFH-0405SLT03	125
CU-PLUGCABLE-2M	130	HNA-U	60	P-PIPESTOP16	83	UFH-0405SLT04	125
CU-PLUGCABLE-2M	134	HNAFL-DN50	61	P-PIPESTOP20	83	UFH-0405SLT05	125
CU-PLUGCABLE-5M	130	HNB	60	P-PIPESTOP26	83	UFH-0405SLT06	125
CU-PLUGCABLE-5M	134	HNB-U	60	P-PIPESTOP32	83	UFH-0405SLT07	125
CU-REGB-230V	129	HNTOOLSET	156	PH-1632	142	UFH-0405SLT08	125
CU-REGB-24V	129	IM1426PRESS	139	PIPEPLUG16	159	UFH-0405SLT09	125
CU-REGB-HC230V	129	IM1426PRESS-N	138	PIPEPLUG20	159	UFH-0405SLT10	125
CU-REGB-HC24V	129	IM63	139	PIPEPLUG26	159	UFH-0405SLT11	125
CU-REGB-RF	132	IMEM1426-PRESS	139	PK-TOOL04	157	UFH-0405SLT12	125
CU-REGC-230V	129	IMEM63	139	PK-TOOL05	157	UFH-0405SLT13	125
CU-REGC-24V	129	ISO-BLOCK-S	12	PK-TOOL06	157	UFH-0405SLT14	125
CU-REGC-RF	133	ISO-BOX	79	PK-TOOLBOX	157	UFH-0405SLT15	125
CU-REGK-230V	129	JCLIP-1632	159	PK-TOOLBOX040506	157	UFH-0405SLT16	125
CU-REGK-24V	129	JCLIP-1632D	159	PLF-P-PK	160	UFH-0405SSTE01-PN6	125
CU-REGS-RF	133	JCLIP-1632DL	159	PLP-P-PK	160	UFH-0405SSTE02-PN6	125
CU-REPEAT	133	JCLIP-1632L	159	PLUG04-B80	155	UFH-0405SSTE03-PN6	125
CU-SENS	133	KS-K	141	PLUG04-R80	155	UFH-0405SSTE04-PN6	125
DRILLY14	155	KS-MSET1	140	PLUG05-B80	155	UFH-0405SSTE06-PN6	125
DRILLY16	155	KS-MSET4	140	PLUG05-R80	155	UFH-0405SSTN01-PN6	125
DRILLY20	155	KS-P162026	141	PRESSCHECK1432	154	UFH-0405SSTN02-PN6	125
DRILLY26	155	KS12M	141	PS-16	140	UFH-0405SSTN03-PN6	125
DRILLY32	155	KS14M	141	PS-20	140	UFH-0405SSTN04-PN6	125
EK12-2	92	KS16M	141	RAD04-100V	106	UFH-0405SSTN05-PN6	125
EK14-2	92	KS18M	141	RADNI-0504	108	UFH-0405SSTN06-PN6	125
EK15	106	KS20M	141	RADTH-VL	106	UFH-0505CDP07	124
EK15	92	KS26M	141	RS32	139	UFH-0505CDP08	124
EK16-2	92	KS32M	141	RSEM1420-PERS	139	UFH-0505CDP09	124
EK17-2	92	KS40M	141	RSEM2640-PERS	139	UFH-0505CDP10	124
EK18-2	92	KS50	141	SAFECUT	140	UFH-0505CDP11	124
EK20-2	92	KS63	141	SK-B05	104	UFH-0505CDP12	124
EKH16-2	92	LB50	12	SK-B05	70	UFH-0505CDP13	124
ENDCAP-EK05	99	M-BA03	142	SK-B05	99	UFH-0505CDP14	124
H-0212	102	M-BAT03	142	SK-PIPESTOP16	69	UFH-0505CDP15	124
H-0212-S	102	M-BATMINI2	150	SK-PIPESTOP20	69	UFH-0505CDP16	124
HBOX-GBD1604	162	M-BATMINI3-1.5AH	148	SK-PIPESTOP26	69	UFH-0505SSTE07-PN6	125
HBOX-GBD2004	162	M-BATMINI3-2.0AH	148	SK-STOPCLIP16	69	UFH-0505SSTE08-PN6	125
HBOX-GBD3P16	162	M-BATMINI3-3.0AH	148	SK-STOPCLIP16	99	UFH-0505SSTE09-PN6	125
HBOX-GBD3P20	162	M-BATMINI3-5.0AH	148	SK-STOPCLIP20	69	UFH-0505SSTE10-PN6	125
HBOX-GR1616	163	M-BH162026	153	SK-STOPCLIP20	99	UFH-0505SSTE11-PN6	125
HBOX-GSP1604	162	M-BHY	144	SK-STOPCLIP26	69	UFH-0505SSTE12-PN6	125
HBOX-GSP3P16	162	M-BHY162026	143	SK-STOPCLIP26	99	UFH-0505SSTN07-PN6	125
HBOX-GWM1604	162	M-BM1620	154	SPLIT-S16	92	UFH-0505SSTN08-PN6	125
HBOX-GWM3P20	162	M-BMINI3	147	SPLIT-S20	92	UFH-0505SSTN09-PN6	125
HBOX-GWT16	162	M-BMINI3-F	147	TESTPLUG16	160	UFH-0505SSTN10-PN6	125
HBOX-GWT3P16	163	M-BMINI3-S	148	TESTPLUG20	160	UFH-0505SSTN11-PN6	125
HBOX-MBD1604	163	M-BOXBA03	143	TESTPLUG26	160	UFH-0505SSTN12-PN6	125
HBOX-MBD2004	163	M-BOXBHY	144	TOOLBOX16202632	145	UFH-060502-MD	121
HBOX-MSP1604	163	M-BOXMINI3	149	TOOLBOX405063	145	UFH-060503-MD	121
HBOX-MWM1604	163	M-BOXMINI3-F	149	UFH-0405CDP01	124	UFH-060504-MD	121
HBOX-MWT3P16	163	M-HP32	153	UFH-0405CDP02	124	UFH-060505-MD	121
HN-PEN	60	M-LAD03	142	UFH-0405CDP03	124	UFH-060506-MD	121
HNA	60	M-LADMINI3	148	UFH-0405CDP04	124	UFH-060507-MD	121
HNA-COMP	61	M-TRANS03	143	UFH-0405CDP05	124	UFH-060508-MD	121
HNA-EK05	61	M-TRANSMINI3	148	UFH-0405CDP06	124	UFH-060509-MD	121

INDEX

Article number	Page	Article number	Page	Article number	Page	Article number	Page
UFH-060510-MD	121	UFH-BEND1218	118	UFH-P18-GP18V	114	VBS-05F	104
UFH-060511-MD	121	UFH-BEND20	118	UFH-P18-WN	114	VBS-06	104
UFH-060512-MD	121	UFH-BM0606-VN	120	UFH-PGKTA	121	VBS-06F	104
UFH-0605CD01	124	UFH-BMH0606-VN	120	UFH-PGKTA-TH	121	VBS050502-BL	103
UFH-0605CD02	124	UFH-BMH0606T-VN	120	UFH-PLUG80	117	VBS050502-RO	103
UFH-0605CD03	124	UFH-BS05-M	123	UFH-PRO	111	VBS050503-BL	103
UFH-0605CD04	124	UFH-BTM0606-M	122	UFH-RAS-BIND15A	112	VBS050503-RO	103
UFH-0605CD05	124	UFH-C191800	126	UFH-RAS-BIND15B	112	VBS050504-BL	103
UFH-0605CD06	124	UFH-C191974	126	UFH-RAS-CLIP16	112	VBS050504-RO	103
UFH-0605CD07	124	UFH-C191976	126	UFH-RAS-CLIP18	112	VBS060502-BL	103
UFH-0605CD08	124	UFH-C192071	126	UFH-RAS-CLIP20	112	VBS060502-RO	103
UFH-0605CD09	124	UFH-C260003001	123	UFH-RAS-CUT	156	VBS060503-BL	103
UFH-0605CD10	124	UFH-CAB-I1000	136	UFH-RAS-RB3	112	VBS060503-RO	103
UFH-0605CD11	124	UFH-CAB-I400	136	UFH-RAS-VLE	156	VBS060504-BL	103
UFH-0605CD12	124	UFH-CAB-I600	136	UFH-RAS10	111	VBS060504-RO	103
UFH-0605CD13	124	UFH-CAB-I800	136	UFH-RAS15	111	VDEK-T05	98
UFH-0605CD14	124	UFH-CAB-O1000	136	UFH-RAS20	111	VDSK-20	99
UFH-0605CD15	124	UFH-CAB-O400	136	UFH-SCOTCH-66	113	VDSK-26	99
UFH-0605CD16	124	UFH-CAB-O600	136	UFH-TACK	156	VEK-060502	101
UFH-0605CD17	124	UFH-CAB-O800	136	UFH-TACK-38K	112	VEK-060503	101
UFH-0605CD18	124	UFH-CMDK03	119	UFH-TACK-40	113	VEK-060503-Z	101
UFH-0605CD19	124	UFH-CMDK10	119	UFH-TACK-60	113	VEK-060504	101
UFH-0605CD20	124	UFH-CMDSS	120	UFH-TACK-KLS20	112	VEK-060504-Z	101
UFH-0605MDK02-03L	119	UFH-CP	124	UFH-TACK-KLS25	112	VEK-060505	101
UFH-0605MDK03-03L	119	UFH-DH40	118	UFH-TACK-KLS30	112	VEK-060505-Z	101
UFH-0605MDK04-03L	119	UFH-DP200	118	UFH-TM050-M	122	VEK-060506-Z	101
UFH-0605MDK05-03L	119	UFH-DRY-1617-150F	113	UFH-UP-12	116	VEK-060507	101
UFH-0605MDK06-03L	119	UFH-DRY-1617-200F	113	UFH-UP-14M1	115	VEK-060507-Z	101
UFH-0605MDK07-03L	119	UFH-DRY-1625-100F	113	UFH-UP-16	116	VEK-060508	101
UFH-0605MDK08-03L	119	UFH-DRY-1625-150F	113	UFH-UP-16M1	115	VEK-060508-Z	101
UFH-0605MDK09-03L	119	UFH-DRY-1625-200F	113	UFH-UP-CUP50	116	VEK-060509-Z	101
UFH-0605MDK10-03L	119	UFH-DRY-1630-150F	113	UFH-VLA	155	VEK-060510-Z	101
UFH-0605MDK11-03L	119	UFH-DRY-B	115	UFH-VLA-STR	155	VISION SET 16	69
UFH-0605MDK12-03L	119	UFH-DRY-FTAPE	113	UFH-VLA-STRHO	155	VISION SET 20	69
UFH-0605MDSS02	120	UFH-DRY-GLUEF	114	V-050404-Z	101	VISION SET 26	69
UFH-0605MDSS03	120	UFH-DRY-GP100-2	115	V-060402	101	VISION-KEY16	69
UFH-0605MDSS04	120	UFH-DRY-VD100	115	V-060404	101	VISION-KEY20	69
UFH-0605MDSS05	120	UFH-ESK060303-M	122	V-060405	101	VISION-KEY26	69
UFH-0605MDSS06	120	UFH-ESK060303-VN	122	V-060406	101	VS-05	102
UFH-0605MDSS07	120	UFH-FOIL-ALU	116	V-060408	101	VS-0504	102
UFH-0605MDSS08	120	UFH-FOIL-CLIP25	116	VB-EK05	102	VS-06	102
UFH-0605MDSS09	120	UFH-FOIL-N	116	VB-EK05	70	VS-0604	102
UFH-0605MDSS10	120	UFH-FOIL50	116	VB-HANDLE-BLUE	102	VS-0605	102
UFH-0605MDSS11	120	UFH-FOIL90	116	VB-HANDLE-RED	102	VS-07	102
UFH-0605MDSS12	120	UFH-GKT	121	VB050502-BLAUW	103	VS-ENDCAP	98
UFH-0605MDSS13	120	UFH-H5004	134	VB050502-ROOD	103	VS-ENDCAP-M	98
UFH-0605MDSS14	120	UFH-ISOBOARD-GV	117	VB050503-BLAUW	103	VSK-1616	70
UFH-0605MDSS15	120	UFH-ISOBOARD-GVNL	117	VB050503-ROOD	103	VSK-161616	70
UFH-ADN10	118	UFH-ISOBOARD-S	117	VB050504-BLAUW	103	VSKEK-0502	96
UFH-ANC-05	130	UFH-ISODRY-25	115	VB050504-ROOD	103	VSKEK-0503	96
UFH-ANC-05	134	UFH-ISOPRO11	111	VB060502-BLAUW	103	VVPK-20	99
UFH-ANC-06	130	UFH-ISOPRO30	111	VB060502-ROOD	103	VVPK-26	99
UFH-ANC-06	134	UFH-M-D	121	VB060503-BLAUW	103	VVPK90-20-D	100
UFH-AO03-MZ	122	UFH-MDK-AO	119	VB060503-ROOD	103	VVPK90-20-U	100
UFH-B0605-VN	120	UFH-MDK-CON	119	VB060504-BLAUW	103	VVPK90-26-D	100
UFH-B0606-M	122	UFH-P18-GP10	114	VB060504-ROOD	103	VVPK90-26-U	100
UFH-B0606-VN	123	UFH-P18-GP18	114	VBS-05	104	VVSK-20	96

Article number	Page
VVSK-20-90	97
VVSK-26	96
VVSK-26-90	97
VVSK-T202020	98
VVSK-T20M20	97
VVSK-T262626	98
VVSK-T26M26	97
WBP-1604-BL	83
WBP-1604-RO	83
WBP-2004-BL	83
WBP-2004-RO	83
WBPL-X	83
WBPL-X	94
WBS-1604-BL	94
WBS-1604-RO	94

WE CARE TO CONNECT



Henco Industries NV | Toekomstlaan 27, 2200 Herentals | Tel. +32 14 28 56 60 | www.henco.be

Publication 06/2022

Technical amendments and printing errors reserved

Reservado el derecho a realizar modificaciones técnicas y errores de impresión

Alterações técnicas e erros de impressão reservados