

# PRODUCT OVERVIEW 2022/02

HENCO **PRODUCT OVERVIEW** 2022

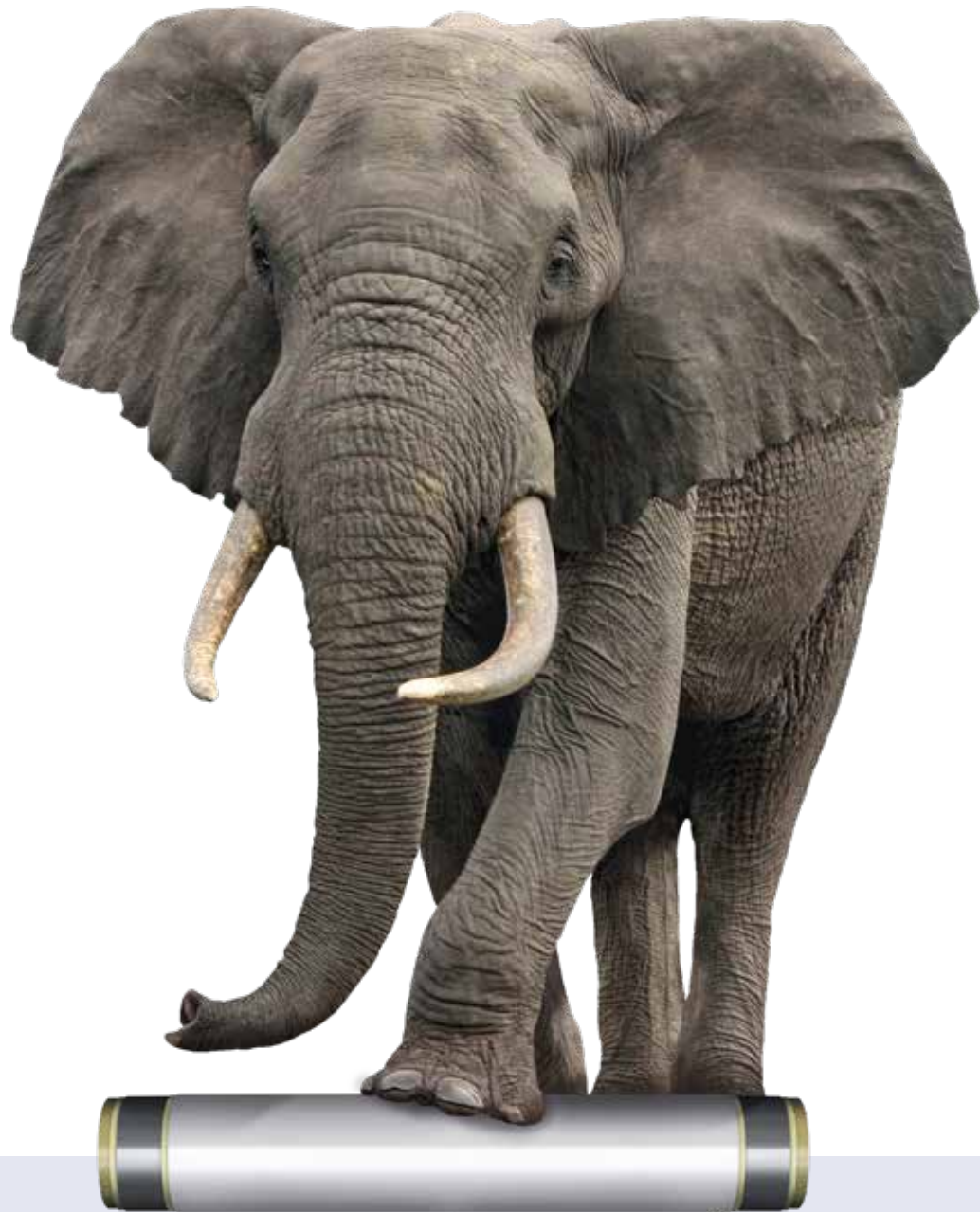

EN / NL / FR / DE



SANITARY



RADIATOR



FLOOR  
HEATING



GAS



SPRINKLER



COMPRESSED  
AIR

# PRODUCT OVERVIEW 2022/02



## WE CARE TO CONNECT

### 1. Pipes

A. STANDARD (PE-Xc/AL/PE-Xc)	6
B. RIXc (PE-Xc/AL/PE-Xc)	7
C. FLOOR-RIXc (PE-Xc/AL/PE-Xc)	12
D. PE-Xc	16
E. PE-RT	17
F. PROTECTION HOSE	18
G. GAS STANDARD (PE-Xc/AL/PE-Xc)	19
H. SPRINKLER	20
	21

<b>2. Henco Press</b>	<b>22</b>
A. PK	23
B. PKW	37
C. PKG	45
D. PKS (SPRINKLER)	50
E. SUPER SIZE	56
F. HENCO ECOLINE	62
<b>3. Henco Vision</b>	<b>63</b>
A. SK	64
B. MANIFOLDS	70
<b>4. Brass press fittings</b>	<b>71</b>
A. P	72
B. PG	84
<b>5. Brass compression fittings</b>	<b>88</b>
<b>6. Manifolds</b>	<b>95</b>
A. FULL FLOW MANIFOLD	96
B. BRASS	101
<b>7. Valves</b>	<b>105</b>
<b>8. Underfloor heating</b>	<b>110</b>
A. SYSTEMS	111
B. MANIFOLDS	119
C. CONTROL UNITS	127
<b>9. Cabinets</b>	<b>135</b>
<b>10. Tools</b>	<b>137</b>
<b>11. Accessories</b>	<b>158</b>
<b>12. Prefab</b>	<b>161</b>
<b>Certificates</b>	<b>164</b>
<b>Index</b>	<b>166</b>



### Sustainability, also our concern

Sustainability is an important concept at Henco. Apart from offering sustainable solutions, such as underfloor heating, we also want to operate sustainably as a company. This implies taking the 3 P's into account: planet, people and profit.

To us, corporate sustainability means paying attention to these three pillars by taking a variety of actions internally. For instance, it is important to deal sustainably with internal employees, to conduct a correct environmental policy and to use our profits wisely.

Recently, we mapped our total CO<sup>2</sup>-footprint, including scope 1, 2 & 3 emissions and developed an action plan to reduce significantly during coming year.



### ISO14001 certified

All the effort we put into environmental matters resulted in Henco getting through the certification audits for ISO14001. After 3 days of audits on various business processes, we achieved a very positive audit result without any recorded remarks. The auditor praised, among other things, the enthusiasm of our employees and the broad demonstration of sustainability throughout our processes.





### **Aalberts Sustainability Award 2021**

Aalberts also saw that we at Henco value sustainability and that we show this through all our actions. In 2022 we were very pleased to accept the Aalberts sustainability awards 2021.

### **The VOKA sustainability charter: SDG pioneers**

The VOKA sustainability charter was achieved by Henco for the 3rd year in a row. With this, we have officially been appointed as SDG pioneers. Sustainability is held in high esteem at Henco, this certificate proves it and we are proud of it.



### **Environmental and health statement Cochebat**

The French HVAC association Cochebat has tested and approved our Henco multilayer pipes and we were rewarded with inclusion in their Environmental and Health Statement.

### **Interseroh Certificate Resources Saved**

In 2020 and 2021 Henco received the Interseroh Certificate for Resources Saved in Germany. By recycling materials in 2021, a calculated 42,269 kilograms of resources and, in addition to this, 5,521 kilograms of greenhouse gases were saved.



	<b>Page</b>
<b>A. STANDARD (PE-Xc/AL/PE-Xc)</b>	<b>7</b>
<b>B. RIXc (PE-Xc/AL/PE-Xc)</b>	<b>12</b>
<b>C. FLOOR-RIXc (PE-Xc/AL/PE-Xc)</b>	<b>16</b>
<b>D. PE-Xc</b>	<b>17</b>
<b>E. PE-RT</b>	<b>18</b>
<b>F. PROTECTION HOSE</b>	<b>19</b>
<b>G. GAS STANDARD (PE-Xc/AL/PE-Xc)</b>	<b>20</b>
<b>H. SPRINKLER</b>	<b>21</b>

## A. STANDARD (PE-Xc/AL/PE-Xc)



### Type: COIL



Henco multilayer pipe (Coil)  
 Henco meerlagenbuis (Rol)  
 Henco tube multicouche (Rouleau)  
 Henco Mehrschichtverbundrohr (Ring)

Article number	m / Pallet	Type	Pallet dimension
100-121688 *	100 m / 2200 m	12x1,6	75x75 cm
200-121688 *	200 m / 3000 m	12x1,6	75x75 cm
100-140210	100 m / 2200 m	14x2	75x75 cm
200-140210	200 m / 3000 m	14x2	80x80 cm
50-160212	50 m / 1500 m	16x2	120x80 cm
100-160212	100 m / 2200 m	16x2	75x75 cm
200-160212	200 m / 2600 m	16x2	75x75 cm
500-160212D	500 m / 2500 m	16x2	80x80 cm
100-180214	100 m / 1700 m	18x2	75x75 cm
200-180214	200 m / 2000 m	18x2	75x75 cm
25-200216	25 m / 800 m	20x2	120x80 cm
50-200216	50 m / 1000 m	20x2	120x80 cm
100-200216	100 m / 1500 m	20x2	75x75 cm
50-260320	50 m / 800 m	26x3	75x75 cm
50-320326	50 m / 650 m	32x3	90x90 cm

\* 6 bar - 60°C

### Type: COIL CSC



Henco multilayer pipe (Coil Small Core)  
 Henco meerlagenbuis (Rol Kleine Kern)  
 Henco tube multicouche (Petit Rouleau Noyau intérieure)  
 Henco Mehrschichtverbundrohr (Ring kleinen Kern)

Article number	m / Pallet	Type	Pallet dimension
10-160212-KB	10 m / 800 m	16x2	120x80 cm
15-160212-KB	15 m / 900 m	16x2	120x80 cm
25-160212-KB	25 m / 1125 m	16x2	120x80 cm
25-200216-KB	25 m / 900 m	20x2	120x80 cm

ID Coil: 28cm



## A. STANDARD (PE-Xc/AL/PE-Xc)

### 1 Type: STRAIGHT LENGTH



Henco multilayer pipe (Straight length)

Henco meerlagenbuis (Stang)

Henco tube multicouche (Barre)

Henco Mehrschichtverbundrohr (Stange)

Article number	Cylinder / Pallet	Type	Pallet dimension
03-160212	75 m / 3600 m	16x2	310x70,5cm
04-160212	100 m / 4800 m	16x2	410x70,5 cm
05-160212	125 m / 6000 m	16x2	510x70,5 cm
03-180214	60 m / 2880 m	18x2	310x70,5 cm
05-180214	100 m / 4800 m	18x2	510x70,5 cm
03-200216	54 m / 2592 m	20x2	310x70,5 cm
04-200216	72 m / 3456 m	20x2	410x70,5 cm
05-200216	90 m / 4320 m	20x2	510x70,5 cm
03-260320	30 m / 1440 m	26x3	310x70,5 cm
04-260320	40 m / 1920 m	26x3	410x70,5 cm
05-260320	50 m / 2400 m	26x3	510x70,5 cm
03-320326	21 m / 1008 m	32x3	310x70,5 cm
04-320326	28 m / 1344 m	32x3	410x70,5 cm
05-320326	35 m / 1680 m	32x3	510x70,5cm
03-403533	27 m / 648 m	40x3,5	310x70,5 cm
04-403533	36 m / 864 m	40x3,5	410x70,5 cm
05-403533	45 m / 1080 m	40x3,5	510x70,5 cm
03-504042	21 m / 504 m	50x4	310x70,5 cm
04-504042	28 m / 672 m	50x4	410x70,5 cm
05-504042	35 m / 840 m	50x4	510x70,5 cm
03-634554	12 m / 288 m	63x4,5	310x70,5 cm
04-634554	16 m / 384 m	63x4,5	410x70,5 cm
05-634554	20 m / 480 m	63x4,5	510x70,5 cm
05-756063	10 m / 240 m	75x6	510x70,5 cm
05-907076	5 m / 240 m	90x7	510x70,5 cm

### Type: ISO4 (6 mm)



REPAIR TAPE p 160

Pre-insulated (Coil)

Voorgeïsoleerd (Rol)

Pré-isolé (Rouleau)

Isoliert (Ring)

Article number	m / Pallet	Type	Pallet dimension
100-ISO4-14-RO	100 m / 1000 m	14x2 red	75x75 cm
100-ISO4-14-BL	100 m / 1000 m	14x2 blue	75x75 cm
50-ISO4-16-RO	50 m / 700 m	16x2 red	75x75 cm
50-ISO4-16-BL	50 m / 700 m	16x2 blue	75x75 cm
100-ISO4-16-RO	100 m / 1300 m	16x2 red	75x75 cm
100-ISO4-16-BL	100 m / 1300 m	16x2 blue	75x75 cm
50-ISO4-18-RO	50 m / 650 m	18x2 red	75x75 cm
50-ISO4-18-BL	50 m / 650 m	18x2 blue	75x75 cm
50-ISO4-20-RO	50 m / 700 m	20x2 red	75x75 cm
50-ISO4-20-BL	50 m / 700 m	20x2 blue	75x75 cm
100-ISO4-20-RO	100 m / 700 m	20x2 red	75x75 cm
100-ISO4-20-BL	100 m / 700 m	20x2 blue	75x75 cm
25-ISO4-26-RO	25 m / 300 m	26x3 red	75x75 cm
25-ISO4-26-BL	25 m / 300 m	26x3 blue	75x75 cm
50-ISO4-26-RO	50 m / 500 m	26x3 red	75x75 cm
50-ISO4-26-BL	50 m / 500 m	26x3 blue	75x75 cm
25-ISO4-32-RO	25 m / 300 m	32x3 red	75x75 cm
25-ISO4-32-BL	25 m / 300 m	32x3 blue	75x75 cm
50-ISO4-32-RO	50 m / 300 m	32x3 red	75x75 cm
50-ISO4-32-BL	50 m / 300 m	32x3 blue	75x75 cm



## A. STANDARD (PE-Xc/AL/PE-Xc)



### Type: ISO9 (10 mm)



REPAIR TAPE p 160

Pre-insulated (Coil)  
Voorgeïsoleerd (Rol)  
Pré-isolé (Rouleau)  
Isoliert (Ring)

Article number	m / Pallet	Type	Pallet dimension
50-ISO9-14-RO	50 m / 550 m	14x2 red	75x75 cm
50-ISO9-14-BL	50 m / 550 m	14x2 blue	75x75 cm
50-ISO9-16-RO	50 m / 550 m	16x2 red	75x75 cm
50-ISO9-16-BL	50 m / 550 m	16x2 blue	75x75 cm
50-ISO9-18-RO	50 m / 500 m	18x2 red	75x75 cm
50-ISO9-18-BL	50 m / 500 m	18x2 blue	75x75 cm
50-ISO9-20-RO	50 m / 500 m	20x2 red	75x75 cm
50-ISO9-20-BL	50 m / 500 m	20x2 blue	75x75 cm
25-ISO9-26-RO	25 m / 275 m	26x3 red	75x75 cm
25-ISO9-26-BL	25 m / 275 m	26x3 blue	75x75 cm
50-ISO9-26-RO	50 m / 450 m	26x3 red	75x75 cm
50-ISO9-26-BL	50 m / 450 m	26x3 blue	75x75 cm
25-ISO9-32-RO	25 m / 250 m	32x3 red	75x75 cm
25-ISO9-32-BL	25 m / 250 m	32x3 blue	75x75 cm
50-ISO9-32-RO	50 m / 350 m	32x3 red	75x75 cm
50-ISO9-32-BL	50 m / 350 m	32x3 blue	75x75 cm

### Type: ISO13 (13 mm)



REPAIR TAPE p 160

Pre-insulated (Coil)  
Voorgeïsoleerd (Rol)  
Pré-isolé (Rouleau)  
Isoliert (Ring)

Article number	m / Pallet	Type	Pallet dimension
50-ISO13-16-RO	50 m / 400 m	16x2 blue	75x75 cm
50-ISO13-16-BL	50 m / 400 m	16x2 blue	75x75 cm
50-ISO13-18-BL	50 m / 400 m	18x2 blue	75x75 cm
50-ISO13-20-RO	50 m / 400 m	20x2 blue	75x75 cm
50-ISO13-20-BL	50 m / 400 m	20x2 blue	75x75 cm
50-ISO13-26-RO	50 m / 400 m	26x3 blue	75x75 cm
50-ISO13-26-BL	50 m / 400 m	26x3 blue	75x75 cm
25-ISO13-32-RO	25 m / 250 m	32x3 blue	75x75 cm
25-ISO13-32-BL	25 m / 200 m	32x3 blue	75x75 cm

### Type: COMBI ISO4 (6 mm)



Henco Combi iso 6 mm (Coil)  
Henco Combi iso 6mm (Rol)  
Henco Combi iso 6mm (Rouleau)  
Henco Combi iso 6mm (Ring)

Article number	m / Pallet	Type	Pallet dimension
50-ISO4-COMBI16	50 m / 400 m	16x2	80x80 cm



## A. STANDARD (PE-Xc/AL/PE-Xc)

### 1 Type: STANDARD PIPE IN PIPE



With colour coded conduit (Coil)

Met mantel (Rol)

Avec gaine (Rouleau)

Mit Mantel (Ring)

Article number	m / Pallet	Type	Pallet dimension
25-014MR	25 m / 500 m	14x2 red	120x80 cm
25-014MB	25 m / 500 m	14x2 blue	120x80 cm
50-014MR	50 m / 800 m	14x2 red	120x80 cm
50-014MB	50 m / 800 m	14x2 blue	120x80 cm
100-014MR	100 m / 1000 m	14x2 red	120x80 cm
100-014MBLACK	100 m / 1000 m	14x2 black	120x80 cm
25-016MR	25 m / 500 m	16x2 red	120x80 cm
25-016MB	25 m / 500 m	16x2 blue	120x80 cm
50-016MR	50 m / 800 m	16x2 red	120x80 cm
50-016MB	50 m / 800 m	16x2 blue	120x80 cm
50-016MBLACK	50 m / 800 m	16x2 black	120x80 cm
100-016MR	100 m / 1000 m	16x2 red	120x80 cm
100-016MB	100 m / 1000 m	16x2 blue	120x80 cm
100-016MBLACK	100 m / 1000 m	16x2 black	120x80 cm
50-018MR	50 m / 800 m	18x2 red	120x80 cm
50-018MB	50 m / 800 m	18x2 blue	120x80 cm
100-018MR	100 m / 1000 m	18x2 red	120x80 cm
100-018MB	100 m / 1000 m	18x2 blue	120x80 cm
25-020MR	25 m / 500 m	20x2 red	120x80 cm
25-020MB	25 m / 500 m	20x2 blue	120x80 cm
25-020MBLACK	25 m / 500 m	20x2 black	120x80 cm
50-020MR	50 m / 800 m	20x2 red	120x80 cm
50-020MB	50 m / 800 m	20x2 blue	120x80 cm
50-020MBLACK	50 m / 800 m	20x2 black	120x80 cm
100-020MB	100 m / 1000 m	20x2 blue	120x80 cm
100-020MR	100 m / 1000 m	20x2 red	120x80 cm
25-026MR	25 m / 500 m	26x3 red	120x80 cm
25-026MB	25 m / 500 m	26x3 blue	120x80 cm
50-026MR	50 m / 500 m	26x3 red	120x80 cm
50-026MB	50 m / 500 m	26x3 blue	120x80 cm
50-026MBLACK	50 m / 500 m	26x3 black	120x80 cm
25-032MR	25 m / 300 m	32x3 red	120x80 cm
25-032MB	25 m / 300 m	32x3 blue	120x80 cm

### Type: COMBI STANDARD



Henco Combi (Coil)

Henco Combi (Rol)

Henco Combi (Rouleau)

Henco Combi (Ring)

Article number	m / Pallet	Type	Pallet dimension
50-COMBI16	50 m / 800 m	16x2	120x80 cm

## A. STANDARD (PE-Xc/AL/PE-Xc)



### Type: FLEX STANDARD



Henco Flex (Coil)  
Henco Flex (Rol)  
Henco Flex (Rouleau)  
Henco Flex (Ring)

Article number	Packing	Type
100-FLEX26	100 m	2 - 26x3 (OD90)
100-FLEX32	100 m	2 - 32x3 (OD125)

TILL EXHAUSTION OF STOCK

### Type: STANDARD PIPE IN PIPE CSC



With colour coded conduit (Coil Small Core)  
Met mantel (Rol Kleine Kern)  
Avec gaine (Petit Rouleau Noyau intérieure)  
Mit Mantel (Ring kleinen Kern)

Article number	Pallet	Type	Pallet dimension
25-016MB-KB	25 m / 600 m	16x2	120x80 cm
25-016MR-KB	25 m / 600 m	16x2	120x80 cm

ID Coil: 28cm

### Type: LB



Henco carcassing pipe Ø 16  
Dubbele radiatorbocht Henco buis Ø 16, doorverbonden einde  
Double courbe radiateur, tube Henco Ø 16, embout fermé  
Heizkörperwinkel doppelt, Henco Rohr Ø 16, durchgestellt Ende

Article number	m	Type
LB50	1 m	50 mm

### Type: ISO-BLOCK-S

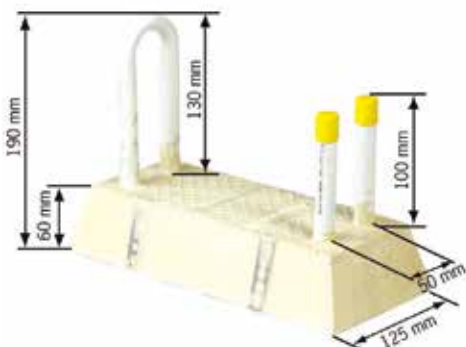

Henco carcassing pipe Ø 16 with insulation  
Dubbele radiatoraansluitbocht met isolatie, Ø 16, doorverbonden einde  
Double courbe radiateur, Ø 16, avec isolation, embout fermé  
Heizkörperwinkel doppelt mit Isolation, Ø 16, durchgestellt Ende

Article number	m	Type
ISO-BLOCK-S	1 m	ISO-BLOCK-S



## B. RIXc (PE-Xc/AL/PE-Xc)

### 1 Type: COIL



Henco multilayer pipe RIXc (Coil)  
 Henco meerlagenbuis RIXc (Rol)  
 Henco tube multicouche RIXc (Rouleau)  
 Henco Merschichtverbundrohr RIXc (Ring)

Article number	m / Pallet	Type	Pallet dimension
50-R160212	50 m / 1500 m	16x2	160x80 cm
100-R160212	100 m / 2200 m	16x2	75x75 cm
200-R160212	200 m / 2600 m	16x2	75x75 cm
500-R160212D	500 m / 2500 m	16x2	75x75 cm
100-R180214	100 m / 1700 m	18x2	75x75 cm
200-R180214	200 m / 2000 m	18x2	75x75 cm
100-R200216	100 m / 1500 m	20x2	75x75 cm
50-R260320	50 m / 800 m	26x3	75x75 cm

### 2 Type: COIL CSC



Henco multilayer pipe RIXc (Coil Small Core)  
 Henco meerlagenbuis RIXc (Rol Kleine Kern)  
 Henco tube multicouche RIXc (Rouleau Petit Noyau)  
 Henco Merschichtverbundrohr RIXc (Ring kleinen Kern)

Article number	Pallet	Type	Pallet dimension
10-R160212-KB	10 m / 800 m	16x2	120x80 cm
15-R160212-KB	15 m / 900 m	16x2	120x80 cm
25-R160212-KB	25 m / 1125 m	16x2	120x80 cm

*ID Coil: 28cm*

### 3 Type: STRAIGHT LENGTH



Henco multilayer pipe RIXc (Straight length)  
 Henco meerlagenbuis RIXc (Stang)  
 Henco tube multicouche RIXc (Barre)  
 Henco Merschichtverbundrohr RIXc (Stange)

Article number	Cylinder / Pallet	Type	Pallet dimension
03-R160212	75 m / 3600 m	16x2	310x75 cm
04-R160212	100 m / 4800 m	16x2	410x75 cm
05-R160212	125 m / 6000 m	16x2	510x75 cm
03-R200216	54 m / 2592 m	20x2	310x75 cm
04-R200216	72 m / 3456 m	20x2	410x75 cm
05-R200216	90 m / 4320 m	20x2	510x75 cm
03-R260320	30 m / 1440 m	26x3	310x75 cm
04-R260320	40 m / 1920 m	26x3	410x75 cm
05-R260320	50 m / 2400 m	26x3	510x75 cm





### Type: ISO4 (6 mm)



REPAIR TAPE p 160

RIXc Pre-insulated (Coil)  
 RIXc Voorgeïsoleerd (Rol)  
 RIXc Pré-isolé (Rouleau)  
 RIXc Isoliert (Ring)

Article number	m / Pallet	Type	Pallet dimension
100-ISO4-R16-RO	100 m / 1300 m	16x2 red	75x75 cm
100-ISO4-R16-BL	100 m / 1300 m	16x2 blue	75x75 cm
50-ISO4-R16-RO	50 m / 700 m	16x2 red	75x75 cm
50-ISO4-R16-BL	50 m / 700 m	16x2 blue	75x75 cm
25-ISO4-R16-RO	25 m / 250 m	16x2 red	75x75 cm
25-ISO4-R16-BL	25 m / 250 m	16x2 blue	75x75 cm
50-ISO4-R18-RO	50 m / 650 m	18x2 red	75x75 cm
50-ISO4-R18-BL	50 m / 650 m	18x2 blue	75x75 cm
50-ISO4-R20-RO	50 m / 700 m	20x2 red	75x75 cm
50-ISO4-R20-BL	50 m / 700 m	20x2 blue	75x75 cm
25-ISO4-R26-RO	25 m / 300 m	26x3 red	75x75 cm
25-ISO4-R26-BL	25 m / 300 m	26x3 blue	75x75 cm
50-ISO4-R26-RO	50 m / 500 m	26x3 red	75x75 cm
50-ISO4-R26-BL	50 m / 500 m	26x3 blue	75x75 cm

### Type: ISO9 (10 mm)



REPAIR TAPE p 160

RIXc Pre-insulated (Coil)  
 RIXc Voorgeïsoleerd (Rol)  
 RIXc Pré-isolé (Rouleau)  
 RIXc Isoliert (Ring)

Article number	m / Pallet	Type	Pallet dimension
50-ISO9-R16-RO	50 m / 550 m	16x2 red	75x75 cm
50-ISO9-R16-BL	50 m / 550 m	16x2 blue	75x75 cm
50-ISO9-R18-BL	50 m / 650 m	18x2 blue	75x75 cm
50-ISO9-R20-RO	50 m / 500 m	20x2 red	75x75 cm
50-ISO9-R20-BL	50 m / 500 m	20x2 blue	75x75 cm
25-ISO9-R26-RO	25 m / 275 m	26x3 red	75x75 cm
25-ISO9-R26-BL	25 m / 275 m	26x3 blue	75x75 cm
50-ISO9-R26-RO	50 m / 450 m	26x3 red	75x75 cm
50-ISO9-R26-BL	50 m / 450 m	26x3 blue	75x75 cm

### Type: ISO13 (13 mm)



REPAIR TAPE p 160

RIXc Pre-insulated (Coil)  
 RIXc Voorgeïsoleerd (Rol)  
 RIXc Pré-isolé (Rouleau)  
 RIXc Isoliert (Ring)

Article number	m / Pallet	Type	Pallet dimension
50-ISO13-R16-RO	50 m / 500 m	16x2 red	75x75 cm
50-ISO13-R16-BL	50 m / 500 m	16x2 blue	75x75 cm
50-ISO13-R20-RO	50 m / 400 m	20x2 red	75x75 cm
50-ISO13-R20-BL	50 m / 400 m	20x2 blue	75x75 cm
50-ISO13-R26-RO	50 m / 350 m	26x3 red	75x75 cm
50-ISO13-R26-BL	50 m / 400 m	26x3 blue	75x75 cm

Type: ISO16 (16 mm)



## B. RIXc (PE-Xc/AL/PE-Xc)

1



RIXc Pre-insulated (Coil)  
 RIXc Voorgeïsoleerd (Rol)  
 RIXc Pré-isolé (Rouleau)  
 RIXc Isoliert (Ring)

Article number	m / Pallet	Type	Pallet dimension
50-ISO20-R16-RO	50 m / 400 m	16x2 red	75x75 cm
50-ISO20-R16-BL	50 m / 400 m	16x2 blue	75x75 cm



REPAIR TAPE p 160

Type: ISO20 (20 mm)

2

3

4

5

6

7

8

9

10

11

12



RIXc Pre-insulated (Coil)  
 RIXc Voorgeïsoleerd (Rol)  
 RIXc Pré-isolé (Rouleau)  
 RIXc Isoliert (Ring)

Article number	m / Pallet	Type	Pallet dimension
50-ISO20-R20-RO	50 m / 400 m	20x2 red	75x75 cm
50-ISO20-R20-BL	50 m / 400 m	20x2 blue	75x75 cm



REPAIR TAPE p 160

Type: ISO26 (26 mm)

RIXc Pre-insulated (Coil)  
 RIXc Voorgeïsoleerd (Rol)  
 RIXc Pré-isolé (Rouleau)  
 RIXc Isoliert (Ring)

Article number	m / Pallet	Type	Pallet dimension
25-ISO20-R26-RO	25 m / 250 m	26x3 red	75x75 cm
25-ISO20-R26-BL	25 m / 250 m	26x3 blue	75x75 cm



REPAIR TAPE p 160

Type: COMBI ISO4 RIXc (6 mm)



Henco Combi iso 6 mm (Coil)  
 Henco Combi iso 6mm (Rol)  
 Henco Combi iso 6mm (Rouleau)  
 Henco Combi iso 6mm (Ring)

Article number	m / Pallet	Type	Pallet dimension
50-ISO4-COMBI16R	50 m / 400 m	16x2	75x75 cm

## B. RIXc (PE-Xc/AL/PE-Xc)



### Type: RIXc PIPE IN PIPE



RIXc With colour coded conduit (Coil)

RIXc Met mantel (Rol)

RIXc Avec gaine (Rouleau)

RIXc Mit Mantel (Ring)

Article number	m / Pallet	Type	Pallet dimension
25-R16MR	25 m / 500 m	16x2 red	120x80 cm
25-R16MB	25 m / 500 m	16x2 blue	120x80 cm
50-R16MR	50 m / 1000 m	16x2 red	120x80 cm
50-R16MB	50 m / 1000 m	16x2 blue	120x80 cm
50-R16MBLACK	50 m / 1000 m	16x2 black	120x80 cm
100-R16MR	100 m / 1000 m	16x2 red	120x80 cm
100-R16MB	100 m / 1000 m	16x2 blue	120x80 cm
100-R16MBLACK	100 m / 1000 m	16x2 black	120x80 cm
50-R18MR	50 m / 800 m	18x2 red	120x80 cm
50-R18MB	50 m / 800 m	18x2 blue	120x80 cm
25-R20MR	25 m / 500 m	20x2 red	120x80 cm
25-R20MB	25 m / 500 m	20x2 blue	120x80 cm
25-R20MBLACK	25 m / 500 m	20x2 black	120x80 cm
50-R20MR	50 m / 800 m	20x2 red	120x80 cm
50-R20MB	50 m / 800 m	20x2 blue	120x80 cm
100-R20MR	100 m / 1000 m	20x2 red	120x80 cm
100-R20MB	100 m / 1000 m	20x2 blue	120x80 cm
50-R26MR	50 m / 500 m	26x3 red	120x80 cm
50-R26MB	50 m / 500 m	26x3 blue	120x80 cm

### Type: COMBI RIXc



Henco Combi (Coil)

Henco Combi (Rol)

Henco Combi (Rouleau)

Henco Combi (Ring)

Article number	m / Pallet	Type	Pallet dimension
50-COMBI16R	50 m / 800 m	16x2	120x80 cm



## C. FLOOR-RIXc (PE-Xc/AL/PE-Xc)

### 1 Type: FLOOR-RIXc



Henco multilayer pipe (Coil)  
Henco meerlagenbuis (Rol)  
Henco tube multicouche (Rouleau)  
Henco Mehrschichtverbundrohr (Ring)

Article number	m / Pallet	Type	Pallet dimension
100-F16R-WZ	100 m / 2200 m	16x2	75x75 cm
200-F16R-WZ	200 m / 2600 m	16x2	80x80 cm
500-F16R-WZ	500 m / 2500 m	16x2	75x75 cm
100-F20R-WZ	100 m / 1000 m	20x2	75x75 cm
400-F20R-WZ	400 m / 1200 m	20x2	75x75 cm

6 bar - 60°C





Type: 5L PE-Xc



- Henco 5L PE-Xc pipe PE-Xc/EVOH/PE-Xc (Coil)
- Henco 5L PE-Xc buis PE-Xc/EVOH/PE-Xc (Rol)
- Henco 5L PE-Xc tube PE-Xc/EVOH/PE-Xc (Rouleau)
- Henco 5L PE-Xc Rohr PE-Xc/EVOH/PE-Xc (Ring)

Article number	m / Pallet	Type	Pallet dimension
200-PXC1620	200 m / 1600 m	16x2	80x80 cm
600-PXC1620	600 m / 2400 m	16x2	80x80 cm
200-PXC1720	200 m / 2000 m	17x2	80x80 cm
600-PXC1720	600 m / 2400 m	17x2	80x80 cm
240-PXC1820	240 m / 2160 m	18x2	80x80 cm
200-PXC2020	200 m / 1000 m	20x2	80x80 cm
600-PXC2020	600 m / 1200 m	20x2	80x80 cm

1

2

3

4

5

6

7

8

9

10

11

12



## E. PE-RT

### 1 Type: 5L PE-RT

2

3

4

5

6

7

8

9

10

11

12



Henco 5L PE-RT pipe PE-RT/EVOH/PE-RT (Coil)

Henco 5L PE-RT buis PE-RT/EVOH/PE-RT (Rol)

Henco 5L PE-RT tube PE-RT/EVOH/PE-RT (Rouleau)

Henco 5L PE-RT Rohr PE-RT/EVOH/PE-RT (Ring)

Article number	m / Pallet	Type	Pallet dimension
120-PRT1620	120 m / 1440 m	16x2	80x80 cm
200-PRT1620	200 m / 1600 m	16x2	80x80 cm
240-PRT1820	240 m / 1440 m	18x2	80x80 cm
600-PRT1620	600 m / 2400 m	16x2	80x80 cm
600-PRT1720	600 m / 2400 m	17x2	80x80 cm
600-PRT1820	600 m / 1200 m	18x2	80x80 cm
600-PRT2020	600 m / 1800 m	20x2	80x80 cm

## F. PROTECTION HOSE



### Type: PROTECTION HOSE



Colour coded conduit (Coil)

Mantel (Rol)

Gaine (Rouleau)

Mantel (Ring)

Article number	m / Pallet	Type	Pallet dimension
100-MR	100 m / 2400 m	Ø14/Ø16/Ø18	120x80 cm
100-MB	100 m / 2400 m	Ø14/Ø16/Ø18 blue	120x80 cm
50-MR20	50 m / 1800 m	Ø20 red	120x80 cm
50-MB20	50 m / 1800 m	Ø20 blue	120x80 cm
50-MR26	50 m / 1200 m	Ø26 red	120x80 cm
50-MB26	50 m / 1200 m	Ø26 blue	120x80 cm
25-MR32	25 m / 1000 m	Ø32 red	120x80 cm
25-MB32	25 m / 1000 m	Ø32 blue	120x80 cm
100-MBLACK	100 m / 2400 m	Ø14/Ø16/Ø18 black	120x80 cm
50-MBLACK20	50 m / 1800 m	Ø20 black	120x80 cm
50-MBLACK26	50 m / 1200 m	Ø26 black	120x80 cm

### Type: PROTECTION HOSE GAS



Colour coded conduit (Coil)

Mantel (Rol)

Gaine (Rouleau)

Mantel (Ring)

Article number	m / Pallet	Type	Pallet dimension
50-MG16	50 m / 2400 m	Ø16 yellow	120x80 cm
100-MG16	100 m / 2400 m	Ø16 yellow	120x80 cm
50-MG20	50 m / 1800 m	Ø20 yellow	120x80 cm
50-MG26	50 m / 1200 m	Ø26 yellow	120x80 cm
25-MG32	25 m / 1000 m	Ø32 yellow	120x80 cm



## G. GAS STANDARD (PE-Xc/AL/PE-Xc)

1

*Gas: only allowed in countries where has been a HENCO GAS testing + certificate is available! (see [www.henco.be](http://www.henco.be))*  
*Gas: enkel toegelaten in landen waar er een HENCO GAS keur is + een certificaat voorhanden is! (zie [www.henco.be](http://www.henco.be))*  
*Gaz: seulement permis dans des pays où le contrôle a eu lieu + certificat est disponible! (Consultez [www.henco.be](http://www.henco.be))*  
*Gas: nur zugelassen in Länder wo HENCO GAS Prüfung geschehen ist + Zertifikat vorhanden ist! (Siehe [www.henco.be](http://www.henco.be))*

2

3

4

### Type: COIL

5

6

7

8

9

10

11

12



**Henco multilayer pipe (Coil)**

**Henco Meerlagenbuis (Rol)**

**Henco tube multicouche (Rouleau)**

**Henco Mehrschichtverbundrohr (Ring)**

Article number	m / Pallet	Type	Pallet dimension
25-160212-GAS	25 m / 800 m	16x2	75x75 cm
50-160212-GAS	50 m / 1500 m	16x2	120x80 cm
25-200216-GAS	25 m / 800 m	20x2	75x75 cm
50-200216-GAS	50 m / 1000 m	20x2	120x80 cm
50-260320-GAS	50 m / 800 m	26x3	75x75 cm
50-320326-GAS	50 m / 650 m	32x3	90x90 cm

### Type: STRAIGHT LENGTH



**Henco multilayer pipe (Straight length)**

**Henco Meerlagenbuis (Stang)**

**Henco tube multicouche (Barre)**

**Henco Mehrschichtverbundrohr (Stange)**

Article number	Cylinder / Pallet	Type	Pallet dimension
05-160212-GAS	125 m / 6000 m	16x2	510x70,5 cm
05-200216-GAS	90 m / 4300 m	20x2	510x70,5 cm
05-260320-GAS	50 m / 2400 m	26x3	510x70,5 cm
05-320326-GAS	35 m / 1680 m	32x3	510x70,5 cm
05-403533-GAS	45 m / 1080 m	40x3,5	510x70,5 cm

### Type: GAS PIPE IN PIPE



**With colour coded conduit (Coil)**

**Met mantel (Rol)**

**Avec gaine (Rouleau)**

**Mit Mantel (Ring)**

Article number	m / Pallet	Typ	Pallet dimension
25-016GASMG	25 m / 500 m	16x2	120x80 cm
50-016GASMG	50 m / 500 m	16x2	120x80 cm
25-020GASMG	25 m / 500 m	20x2	120x80 cm
50-020GASMG	50 m / 800 m	20x2	120x80 cm
25-026GASMG	25 m / 500 m	26x3	120x80 cm
50-026GASMG	50 m / 500 m	26x3	120x80 cm
25-032GASMG	25 m / 300 m	32x3	120x80 cm

*Gastec: Standard pipe gas in combination with Henco press fittings synthetic for gas, see page 40*

*DVGW and Kiwa Uni: Standard pipe gas in combination with Henco brass press fittings for gas, see page 85*







*Sprinkler: only allowed in countries where a HENCO Sprinkler certificate is available! (see [www.henco.be](http://www.henco.be))*  
*Sprinkler: enkel toegelaten in landen waar een HENCO Sprinkler certificaat voorhanden is! (zie [www.henco.be](http://www.henco.be))*  
*Sprinkler: seulement permis dans des pays où le HENCO Sprinkler certificat est disponible! (consultez [www.henco.be](http://www.henco.be))*  
*Sprinkler: nur zugelassen in Länder wo HENCO Sprinkler Zertifikat vorhanden ist! (siehe [www.henco.be](http://www.henco.be))*

## Type: COIL



**Henco multilayer pipe (Coil)**  
**Henco Meerlagenbuis (Rol)**  
**Henco tube multicouche (Rouleau)**  
**Henco Mehrschichtverbundrohr (Ring)**

Article number	m / Pallet	Type	Pallet dimension
50-260320-SPR	50 m / 1440 m	26 x 3	310x70,5 cm
50-320326-SPR	50 m / 1920 m	32 x 3	410x70,5 cm

## Type: Straight length



**Henco multilayer pipe (Straight length)**  
**Henco meerlagenbuis (stang)**  
**Henco tube multicouche (Barre)**  
**Henco Merhschichtverbundrohr (Stange)**

Article number	Cylinder / Pallet	Type	Pallet dimension
05-320326-SPR	35 m / 1680 m	32 x 3	510x70,5 cm
05-403533-SPR	45 m / 1080 m	40 x 3,5	510x70,5 cm
05-504042-SPR	35 m / 840 m	50 x 4	510x70,5 cm
05-634554-SPR	20 m / 480 m	63 x 4,5	510x70,5 cm

Standard pipe Sprinkler in combination with Henco press fittings synthetic for Sprinkler, see page 50

Sprinkler Cup: see page 55



# HENCO PRESS - HENCO PERS RACCORDS À SERTIR HENCO - HENCO PRESS



	<i>Page</i>
<b>A. PK</b>	<b>23</b>
<b>B. PKW</b>	<b>37</b>
<b>C. PKG</b>	<b>45</b>
<b>D. PKS</b>	<b>50</b>
<b>E. SUPER SIZES</b>	<b>56</b>
<b>F. ECOLINE</b>	<b>62</b>



**Type: 1PK**



Elbow 90°  
Knie 90°  
Coude 90°  
Winkel 90°

Article number	Bag / Box	Type
1PK-1414	10 pc. / 150 pc.	14x14
1PK-1616	10 pc. / 120 pc.	16x16
1PK-1818	10 pc. / 100 pc.	18x18
1PK-2020	10 pc. / 80 pc.	20x20
1PK-2626	5 pc. / 50 pc.	26x26
1PK-3232	5 pc. / 30 pc.	32x32
1PK-4040	5 pc. / 20 pc.	40x40
1PK-5050	1 pc. / 8 pc.	50x50
1PK-6363	1 pc. / 6 pc.	63x63

Article number	Box	Type
1PK-7575	1 pc.	75x75
1PK-9090	1 pc.	90x90

For the composition of Super Sizes, see p. 56

**Type: 1PK-JG**



Elbow 90° 16x10JG (ceiling cooling)  
Knie 90° 16x10JG (koelplafond)  
Coude 90° 16x10JG (plafond climatisé)  
Winkel 90° 16x10JG (Klimaatplafond)

Article number	Bag / Box	Type
1PK-16JG10	10 pc. / 120 pc.	16x10JG
1PK-20JG10	10 pc. / 100 pc.	20x10JG

**Type: 2PK**



Backplate elbow female  
Sanitair muurplaat binnendraad  
Culasse pour sanitaire  
Sanitär Wandscheibe IG

Article number	Bag / Box	Type
2PK-1404BP*	10 pc. / 50 pc.	14x1/2" (56 mm)
2PK-1603	10 pc. / 50 pc.	16x3/8" (56 mm)
2PK-1604BP*	10 pc. / 50 pc.	16x1/2" (56 mm)
2PK-1804BP*	10 pc. / 50 pc.	18x1/2" (56 mm)
2PK-2004BP*	10 pc. / 50 pc.	20x1/2" (56 mm)
2PK-2005	5 pc. / 30 pc.	20x3/4" (56 mm)
2PK-2605	5 pc. / 30 pc.	26x3/4" (56 mm)

\* With black plug BP04 1/2

**Type: 2PK-X (INOX)**



Backplate elbow female  
Sanitair muurplaat binnendraad  
Culasse pour sanitaire  
Sanitär Wandscheibe IG

Article number	Bag / Box	Type
2PK-1404-X	10 pc. / 50 pc.	14x1/2" (56 mm)
2PK-1604-X	10 pc. / 50 pc.	16x1/2" (56 mm)
2PK-1804-X	10 pc. / 50 pc.	18x1/2" (56 mm)
2PK-2004-X	10 pc. / 50 pc.	20x1/2" (56 mm)
2PK-2005-X	5 pc. / 30 pc.	20x3/4" (56 mm)
2PK-2605-X	5 pc. / 30 pc.	26x3/4" (56 mm)



## A. PK

### Type: 2PK-K

56 mm



**Backplate elbow female, short model**  
**Sanitair muurplaat binnendraad, laag**  
**Culasse pour sanitaire, modèle court**  
**Sanitär Wandscheibe IG, kurzes Modell**

Article number	Bag / Box	Type
2PK-1604KBP*	10 pc. / 50 pc.	16x1/2" (40 mm)

\* With black plug BP04 1/2"

Accessory 2PK & 2PK-K: galvanised bracket plate - see page 154

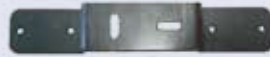

PLP-P-PK



PLF-P-PK

### Type: 3PK

40 mm



**Double backplate elbow female, short model**  
**Sanitair muurplaat binnendraad dubbel, laag**  
**Culasse double pour sanitaire, modèle court**  
**Sanitär Wandscheibe doppelt IG, kurzes Modell**

Article number	Bag / Box	Type
3PK-160416BP*	10 pc. / 30 pc.	16x1/2"x16 (40 mm)
3PK-200420BP*	10 pc. / 30 pc.	20x1/2"x20 (40 mm)
3PK-200420-X	10 pc. / 30 pc.	20x1/2"x20 (40 mm)

\* With black plug BP04 1/2"

### Type: 3PK-X (INOX)

40 mm



**Double backplate elbow female, short model**  
**Sanitair muurplaat binnendraad dubbel, laag**  
**Culasse double pour sanitaire, modèle court**  
**Sanitär Wandscheibe doppelt IG, kurzes Modell**

Article number	Bag / Box	Type
3PK-160416-X	10 pc. / 30 pc.	16x1/2"x16 (40 mm)

### Type: BP04



**Black plug for 1/2" female nipple**  
**Zwarte stop voor 1/2"**  
**Bouchon noir pour 1/2" nipple femelle**  
**Schwarzen Stopf für 1/2" Nippel**

Article number	Bag / Box	Type
BP04	50 pc. / 500 pc.	1/2"



**Type: 5PK (CW617)**



**Bend 90° male adapter**  
**Knie 90° buitendraad**  
**Coude 90° mâle**  
**Winkel 90° AG**

Article number	Bag / Box	Type
5PK-1404	10 pc. / 60 pc.	14x1/2"
5PK-1604	10 pc. / 60 pc.	16x1/2"
5PK-1804	10 pc. / 60 pc.	18x1/2"
5PK-2004	10 pc. / 60 pc.	20x1/2"
5PK-2005	10 pc. / 50 pc.	20x3/4"
5PK-2605	10 pc. / 40 pc.	26x3/4"
5PK-3206	5 pc. / 20 pc.	32x1"
5PK-4007	3 pc. / 15 pc.	40x1 1/4"
5PK-5007	1 pc. / 10 pc.	50x1 1/4"
5PK-5008	1 pc. / 8 pc.	50x1 1/2"
5PK-6310	1 pc. / 4 pc.	63x2"

Article number	Box	Type
5PK-7510	1 pc.	75x2"
5PK-7512	1 pc.	75x2 1/2"

*For the composition of Super Sizes, see p. 56*

**Type: 5PK-N (CW602)**



**Bend 90° male adapter**  
**Knie 90° buitendraad**  
**Coude 90° mâle**  
**Winkel 90° AG**

Article number	Bag / Box	Type
5PK-4007-N	3 pc. / 15 pc.	40x1 1/4"
5PK-5007-N	1 pc. / 10 pc.	50x1 1/4"
5PK-5008-N	1 pc. / 8 pc.	50x1 1/2"
5PK-6310-N	1 pc. / 4 pc.	63x2"

**Type: 6PK (CW617)**



**Bend 90° female adapter**  
**Knie 90° binnendraad**  
**Coude 90° femelle**  
**Winkel 90° IG**

Article number	Bag / Box	Type
6PK-1404BP*	10 pc. / 60 pc.	14x1/2"
6PK-1603	10 pc. / 60 pc.	16x3/8"
6PK-1604BP*	10 pc. / 60 pc.	16x1/2"
6PK-1804BP*	10 pc. / 60 pc.	18x1/2"
6PK-2004BP*	10 pc. / 60 pc.	20x1/2"
6PK-2005	10 pc. / 50 pc.	20x3/4"
6PK-2605	10 pc. / 50 pc.	26x3/4"
6PK-3206	5 pc. / 20 pc.	32x1"
6PK-4007	5 pc. / 15 pc.	40x1 1/4"
6PK-5007	1 pc. / 8 pc.	50x1 1/4"
6PK-5008	1 pc. / 8 pc.	50x1 1/2"
6PK-6310	1 pc. / 4 pc.	63x2"

Article number	Box	Type
6PK-7506	1 pc.	75x1"
6PK-7510	1 pc.	75x2"
6PK-7512	1 pc.	75x2 1/2"
6PK-9014	1 pc.	90x3"

*For the composition of Super Sizes, see p. 56*





## A. PK

1

2

3

4

5

6

7

8

9

10

11

12

### Type: 6PK-X (INOX)



Bend 90° female adapter

Knie 90° binnendraad

Coude 90° femelle

Winkel 90° IG

Article number	Bag / Box	Type
6PK-1404-X	10 pc. / 60 pc.	14x1/2"
6PK-1604-X	10 pc. / 60 pc.	16x1/2"
6PK-1804-X	10 pc. / 60 pc.	18x1/2"
6PK-2004-X	10 pc. / 60 pc.	20x1/2"
6PK-2005-X	10 pc. / 50 pc.	20x3/4"
6PK-2605-X	10 pc. / 50 pc.	26x3/4"
6PK-3206-X	5 pc. / 20 pc.	32x1"
6PK-4007-X	5 pc. / 15 pc.	40x1 1/4"
6PK-5007-X	1 pc. / 8 pc.	50x1 1/4"
6PK-5008-X	1 pc. / 8 pc.	50x1 1/2"
6PK-6310-X	1 pc. / 4 pc.	63x2"

### Type: 6PK-N (CW602)



Bend 90° female adapter

Knie 90° binnendraad

Coude 90° femelle

Winkel 90° IG

Article number	Bag / Box	Type
6PK-4007-N	5 pc. / 15 pc.	40x1 1/4"
6PK-5007-N	1 pc. / 8 pc.	50x1 1/4"
6PK-5008-N	1 pc. / 8 pc.	50x1 1/2"
6PK-6310-N	1 pc. / 4 pc.	63x2"

### Type: 9PK



T-piece

T-stuk

Pièce en T

T-Stück

Article number	Bag / Box	Type
9PK-141414	10 pc. / 100 pc.	14x14x14
9PK-161616	10 pc. / 60 pc.	16x16x16
9PK-181818	10 pc. / 60 pc.	18x18x18
9PK-202020	10 pc. / 50 pc.	20x20x20
9PK-262626	5 pc. / 30 pc.	26x26x26
9PK-323232	5 pc. / 15 pc.	32x32x32
9PK-404040	5 pc. / 10 pc.	40x40x40
9PK-505050	1 pc. / 6 pc.	50x50x50
9PK-636363	1 pc. / 3 pc.	63x63x63

Article number	Box	Type
9PK-757575	1 pc.	75x75x75
9PK-909090	1 pc.	90x90x90

For the composition of Super Sizes, see p. 56



**Type: 10PK**



T-reduced centre  
T-verlopend  
Pièce en T-réduit  
T-reduziert

Article number	Bag / Box	Type
10PK-161416	10 pc. / 50 pc.	16x14x16
10PK-181418	10 pc. / 50 pc.	18x14x18
10PK-181618	10 pc. / 50 pc.	18x16x18
10PK-201420	10 pc. / 50 pc.	20x14x20
10PK-201620	10 pc. / 50 pc.	20x16x20
10PK-201820	10 pc. / 50 pc.	20x18x20
10PK-261626	5 pc. / 30 pc.	26x16x26
10PK-261826	5 pc. / 30 pc.	26x18x26
10PK-262026	5 pc. / 30 pc.	26x20x26
10PK-321632	5 pc. / 25 pc.	32x16x32
10PK-321832	5 pc. / 25 pc.	32x18x32
10PK-322032	5 pc. / 25 pc.	32x20x32
10PK-322632	5 pc. / 20 pc.	32x26x32
10PK-401640	5 pc. / 15 pc.	40x16x40
10PK-402040	5 pc. / 15 pc.	40x20x40
10PK-402640	5 pc. / 15 pc.	40x26x40
10PK-403240	5 pc. / 10 pc.	40x32x40
10PK-502050	1 pc. / 6 pc.	50x20x50
10PK-502650	1 pc. / 8 pc.	50x26x50
10PK-503250	1 pc. / 8 pc.	50x32x50
10PK-504050	1 pc. / 6 pc.	50x40x50
10PK-632663	1 pc. / 4 pc.	63x26x63
10PK-633263	1 pc. / 3 pc.	63x32x63
10PK-634063	1 pc. / 3 pc.	63x40x63
10PK-635063	1 pc. / 3 pc.	63x50x63



Article number	Box	Type
10PK-753275	1 pc.	75x32x75
10PK-754075	1 pc.	75x40x75
10PK-755075	1 pc.	75x50x75
10PK-756375	1 pc.	75x63x75
10PK-903290	1 pc.	90x32x90
10PK-904090	1 pc.	90x40x90
10PK-905090	1 pc.	90x50x90
10PK-906390	1 pc.	90x63x90
10PK-907590	1 pc.	90x75x90

For the composition of Super Sizes, see p. 56

**Type: 10PK-JG**



T-reduced centre 16x10JGx16 (ceiling cooling)  
T-verlopend 16x10JGx16 (koelplafond)  
Pièce en T-réduit 16x10JGx16 (plafond climatisé)  
T-reduziert 16x10JGx16 (Klimaatplafond)

Article number	Bag / Box	Type
10PK-16JG1016	10 pc. / 50 pc.	16x10JGx16
10PK-20JG1020	10 pc. / 50 pc.	20x10JGx20



## A. PK

### Type: 11PK



#### T-branch and line reduced

#### T-2x verlopend

#### Pièce en T 2x réduit

#### T-2x reduziert

Article number	Bag / Box	Type
11PK-161414	10 pc. / 50 pc.	16x14x14
11PK-181616	10 pc. / 50 pc.	18x16x16
11PK-201616	10 pc. / 50 pc.	20x16x16
11PK-201818	10 pc. / 50 pc.	20x18x18
11PK-202016	10 pc. / 50 pc.	20x20x16
11PK-261616	10 pc. / 50 pc.	26x16x16
11PK-261620	5 pc. / 30 pc.	26x16x20
11PK-262016	5 pc. / 30 pc.	26x20x16
11PK-262020	5 pc. / 30 pc.	26x20x20
11PK-262616	5 pc. / 30 pc.	26x26x16
11PK-262620	5 pc. / 30 pc.	26x26x20
11PK-322026	5 pc. / 20 pc.	32x20x26
11PK-322626	5 pc. / 20 pc.	32x26x26
11PK-402032	5 pc. / 15 pc.	40x20x32
11PK-402632	5 pc. / 15 pc.	40x26x32
11PK-403232	5 pc. / 10 pc.	40x32x32
11PK-404026	5 pc. / 10 pc.	40x40x26
11PK-404032	5 pc. / 10 pc.	40x40x32
11PK-502040	1 pc. / 10 pc.	50x20x40
11PK-502640	1 pc. / 10 pc.	50x26x40
11PK-503240	1 pc. / 10 pc.	50x32x40
11PK-504040	1 pc. / 8 pc.	50x40x40



Article number	Box	Type
11PK-753232	1 pc.	75x32x32
11PK-753240	1 pc.	75x32x40
11PK-753250	1 pc.	75x32x50
11PK-753263	1 pc.	75x32x63
11PK-753275	1 pc.	75x32x75
11PK-754040	1 pc.	75x40x40
11PK-754050	1 pc.	75x40x50
11PK-754063	1 pc.	75x40x63
11PK-755050	1 pc.	75x50x50
11PK-755063	1 pc.	75x50x63
11PK-756363	1 pc.	75x63x63
11PK-903232	1 pc.	90x32x32
11PK-903240	1 pc.	90x32x40
11PK-903250	1 pc.	90x32x50
11PK-903263	1 pc.	90x32x63
11PK-903275	1 pc.	90x32x75
11PK-903290	1 pc.	90x32x90
11PK-904040	1 pc.	90x40x40
11PK-904050	1 pc.	90x40x50
11PK-904063	1 pc.	90x40x63
11PK-904075	1 pc.	90x40x75
11PK-905050	1 pc.	90x50x50
11PK-905063	1 pc.	90x50x63
11PK-905075	1 pc.	90x50x75
11PK-906363	1 pc.	90x63x63
11PK-906375	1 pc.	90x63x75
11PK-907575	1 pc.	90x75x75

For the composition of Super Sizes, see p. 56



**Type: 12PK**



**T-enlarged branch  
T-vergroot  
Pièce en T agrandi  
T-erweitert**

Article number	Bag / Box	Type
12PK-161816	10 pc. / 50 pc.	16x18x16
12PK-162016	10 pc. / 50 pc.	16x20x16
12PK-202620	5 pc. / 30 pc.	20x26x20
12PK-263226	5 pc. / 20 pc.	26x32x26
12PK-324032	5 pc. / 15 pc.	32x40x32
12PK-405040	1 pc. / 8 pc.	40x50x40

Article number	Box	Type
12PK-327532	1 pc.	32x75x32
12PK-329032	1 pc.	32x90x32
12PK-407540	1 pc.	40x75x40
12PK-507550	1 pc.	50x75x50
12PK-637563	1 pc.	63x75x63
12PK-409040	1 pc.	40x90x40
12PK-509050	1 pc.	50x90x50
12PK-639063	1 pc.	63x90x63
12PK-759075	1 pc.	75x90x75

For the composition of Super Sizes, see p. 56

**Type: 13PK (CW617)**



PK-TOOL p 157



**T-female centre  
T-binnendraad  
Pièce en T femelle  
T-IG**

Article number	Bag / Box	Type
13PK-160416BP*	10 pc. / 50 pc.	16x1/2"x16
13PK-180418BP*	10 pc. / 50 pc.	18x1/2"x18
13PK-200420BP*	10 pc. / 50 pc.	20x1/2"x20
13PK-200520	10 pc. / 30 pc.	20x3/4"x20
13PK-260420BP*	5 pc. / 30 pc.	26x1/2"x20
13PK-260426BP*	5 pc. / 30 pc.	26x1/2"x26
13PK-260526	5 pc. / 30 pc.	26x3/4"x26
13PK-320532	5 pc. / 15 pc.	32x3/4"x32
13PK-320632	5 pc. / 10 pc.	32x1"x32
13PK-320732	5 pc. / 10 pc.	32x1 1/4"x32
13PK-400540	5 pc. / 10 pc.	40x3/4"x40
13PK-400640	5 pc. / 10 pc.	40x1"x40
13PK-400740	5 pc. / 10 pc.	40x1 1/4"x40
13PK-500550	1 pc. 6 pc.	50x3/4"x50
13PK-500850	1 pc. / 4 pc.	50x1 1/2"x50
13PK-631063	1 pc. / 2 pc.	63x2"x63

\* With black plug BP04 1/2

Article number	Box	Type
13PK-750675	1 pc.	75x1"x75
13PK-751075	1 pc.	75x2"x75
13PK-751275	1 pc.	75x2 1/2"x75
13PK-901490	1 pc.	90x3"x90

For the composition of Super Sizes, see p. 57



## A. PK

### Type: 13PK-X (INOX)



T-female centre  
T-binnendraad  
Pièce en T femelle  
T-IG

Article number	Bag / Box	Type
13PK-160416-X	10 pc. / 50 pc.	16x1/2"x16
13PK-180418-X	10 pc. / 50 pc.	18x1/2"x18
13PK-200420-X	10 pc. / 50 pc.	20x1/2"x20
13PK-200520-X	10 pc. / 30 pc.	20x3/4"x20
13PK-260420-X	5 pc. / 30 pc.	26x1/2"x20
13PK-260426-X	5 pc. / 30 pc.	26x1/2"x26
13PK-260526-X	5 pc. / 30 pc.	26x3/4"x26
13PK-320532-X	5 pc. / 15 pc.	32x3/4"x32
13PK-320632-X	5 pc. / 10 pc.	32x1"x32
13PK-320732-X	5 pc. / 10 pc.	32x1 1/4"x32
13PK-400540-X	5 pc. / 10 pc.	40x3/4"x40
13PK-400640-X	5 pc. / 10 pc.	40x1"x40
13PK-400740-X	5 pc. / 10 pc.	40x1 1/4"x40
13PK-500550-X	1 pc. / 6 pc.	50x3/4"x50
13PK-500850-X	1 pc. / 4 pc.	50x1 1/2"x50
13PK-631063-X	1 pc. / 2 pc.	63x2"x63

### Type: 13PK-N (CW602)



T-female centre  
T-binnendraad  
Pièce en T femelle  
T-IG

Article number	Bag / Box	Type
13PK-400540-N	5 pc. / 10 pc.	40x1/2"x40
13PK-400640-N	5 pc. / 10 pc.	40x1"x40
13PK-400740-N	5 pc. / 10 pc.	40x1 1/4"x40
13PK-500550-N	1 pc. / 6 pc.	50x3/4"x50
13PK-500850-N	1 pc. / 4 pc.	50x1 1/2"x50
13PK-631063-N	1 pc. / 2 pc.	63x2"x63



PK-TOOL p 157





**Type: 14PK (CW617)**



PK-TOOL p 157



T-male centre  
T-buitendraad  
Pièce en T mâle  
T-AG

Article number	Bag / Box	Type
14PK-160416	10 pc. / 50 pc.	16x1/2"x16
14PK-180418	10 pc. / 50 pc.	18x1/2"x18
14PK-200420	10 pc. / 40 pc.	20x1/2"x20
14PK-200520	10 pc. / 30 pc.	20x3/4"x20
14PK-260426	5 pc. / 30 pc.	26x1/2"x26
14PK-260526	5 pc. / 25 pc.	26x3/4"x26
14PK-260626	5 pc. / 20 pc.	26x1"x26
14PK-320532	5 pc. / 15 pc.	32x3/4"x32
14PK-400640	5 pc. / 10 pc.	40x1"x40
14PK-400740	5 pc. / 10 pc.	40x1 1/4"x40
14PK-500850	1 pc. / 5 pc.	50x1 1/2"x50
14PK-631063	1 pc. / 2 pc.	63x2"x63

Article number	Box	Type
14PK-751075	1 pc.	75x2"x75
14PK-751275	1 pc.	75x2 1/2"x75

*For the composition of Super Sizes, see p. 57*

**Type: 14PK-N (CW602)**



PK-TOOL p 157

T-male centre  
T-buitendraad  
Pièce en T mâle  
T-AG

Article number	Bag / Box	Type
14PK-400640-N	5 pc. / 10 pc.	40x1"x40
14PK-400740-N	5 pc. / 10 pc.	40x1 1/4"x40
14PK-500850-N	1 pc. / 5 pc.	50x1 1/2"x50
14PK-631063-N	1 pc. / 2 pc.	63x2"x63



## A. PK

### 1 Type: 15PK



**Straight coupling**  
**Doorverbinder recht / perssok**  
**Manchon**  
**Kupplung**

Article number	Bag / Box	Type
15PK-1414	10 pc. / 150 pc.	14x14
15PK-1616	10 pc. / 150 pc.	16x16
15PK-1818	10 pc. / 100 pc.	18x18
15PK-2020	10 pc. / 80 pc.	20x20
15PK-2626	5 pc. / 50 pc.	26x26
15PK-3232	5 pc. / 30 pc.	32x32
15PK-4040	5 pc. / 25 pc.	40x40
15PK-5050	1 pc. / 12 pc.	50x50
15PK-6363	1 pc. / 9 pc.	63x63

Article number	Box	Type
15PK-7575	1 pc.	75x75
15PK-9090	1 pc.	90x90

*For the composition of Super Sizes, see p. 57*

### 11 Type: 16PK



**Reducing coupling**  
**Verloopstuk**  
**Réduction**  
**Kupplung-reduziert**

Article number	Bag / Box	Type
16PK-1614	10 pc. / 100 pc.	16x14
16PK-1814	10 pc. / 100 pc.	18x14
16PK-1816	10 pc. / 100 pc.	18x16
16PK-2014	10 pc. / 100 pc.	20x14
16PK-2016	10 pc. / 100 pc.	20x16
16PK-2018	10 pc. / 100 pc.	20x18
16PK-2616	5 pc. / 60 pc.	26x16
16PK-2618	5 pc. / 50 pc.	26x18
16PK-2620	5 pc. / 50 pc.	26x20
16PK-3216	5 pc. / 50 pc.	32x16
16PK-3220	5 pc. / 40 pc.	32x20
16PK-3226	5 pc. / 40 pc.	32x26
16PK-4026	5 pc. / 30 pc.	40x26
16PK-4032	5 pc. / 25 pc.	40x32
16PK-5032	1 pc. / 15 pc.	50x32
16PK-5040	1 pc. / 15 pc.	50x40
16PK-6340	1 pc. / 8 pc.	63x40
16PK-6350	1 pc. / 8 pc.	63x50

Article number	Box	Type
16PK-7532	1 pc.	75x32
16PK-7540	1 pc.	75x40
16PK-7550	1 pc.	75x50
16PK-7563	1 pc.	75x63
16PK-9032	1 pc.	90x32
16PK-9040	1 pc.	90x40
16PK-9050	1 pc.	90x50
16PK-9063	1 pc.	90x63
16PK-9075	1 pc.	90x75

*For the composition of Super Sizes, see p. 57*



**Type: 17PK (CW617)**



PK-TOOL p 157



**Straight male adapter**  
**Recht aansluitstuk buitendraad / Puntstuk**  
**Raccord droit mâle**  
**Übergangsfitting AG**

Article number	Bag / Box	Type
17PK-1404	10 pc. / 80 pc.	14x1/2"
17PK-1604	10 pc. / 80 pc.	16x1/2"
17PK-1804	10 pc. / 80 pc.	18x1/2"
17PK-1805	10 pc. / 50 pc.	18x3/4"
17PK-2004	10 pc. / 80 pc.	20x1/2"
17PK-2005	10 pc. / 50 pc.	20x3/4"
17PK-2605	10 pc. / 50 pc.	26x3/4"
17PK-2606	10 pc. / 40 pc.	26x1"
17PK-3206	10 pc. / 40 pc.	32x1"
17PK-3207	5 pc. / 25 pc.	32x1 1/4"
17PK-4006	5 pc. / 25 pc.	40x1"
17PK-4007	5 pc. / 25 pc.	40x1 1/4"
17PK-5008	1 pc. / 10 pc.	50x1 1/2"
17PK-6310	1 pc. / 6 pc.	63x2"

Article number	Box	Type
17PK-7510	See page 54	75x2"
17PK-7512	See page 54	75x2 1/2"

*For the composition of Super Sizes, see p. 58*

**Type: 17PK-N (CW602)**



PK-TOOL p 157

**Straight male adapter**  
**Recht aansluitstuk buitendraad / Puntstuk**  
**Raccord droit mâle**  
**Übergangsfitting AG**

Article number	Bag / Box	Type
17PK-4006-N	5 pc. / 25 pc.	40x1"
17PK-4007-N	5 pc. / 25 pc.	40x1 1/4"
17PK-5008-N	1 pc. / 10 pc.	50x1 1/2"
17PK-6310-N	1 pc. / 6 pc.	63x2"



## A. PK

### Type: 18PK (CW617)



PK-TOOL p 157



**Straight female adapter**  
**Recht aansluitstuk binnendraad / Schroefbus**  
**Raccord droit femelle**  
**Übergangsfitting IG**

Article number	Bag / Box	Type
18PK-1404	10 pc. / 80 pc.	14x1/2"
18PK-1604	10 pc. / 80 pc.	16x1/2"
18PK-1804	10 pc. / 80 pc.	18x1/2"
18PK-1805	10 pc. / 50 pc.	18x3/4"
18PK-2004	10 pc. / 80 pc.	20x1/2"
18PK-2005	10 pc. / 50 pc.	20x3/4"
18PK-2605	10 pc. / 50 pc.	26x3/4"
18PK-2606	10 pc. / 40 pc.	26x1"
18PK-3206	10 pc. / 40 pc.	32x1"
18PK-3207	5 pc. / 25 pc.	32x1 1/4"
18PK-4006	5 pc. / 25 pc.	40x1"
18PK-4007	5 pc. / 25 pc.	40x1 1/4"
18PK-5008	1 pc. / 10 pc.	50x1 1/2"
18PK-6310	1 pc. / 6 pc.	63x2"

Article number	Box	Type
18PK-7506	1 pc.	75x1"
18PK-7510	1 pc.	75x2"
18PK-7512	1 pc.	75x2 1/2"
18PK-9014	1 pc.	90x3"

*For the composition of Super Sizes, see p. 58*

### Type: 18PK-X (INOX)



**Straight female adapter**  
**Recht aansluitstuk binnendraad / Schroefbus**  
**Raccord droit femelle**  
**Übergangsfitting IG**

Article number	Bag / Box	Type
18PK-1604-X	10 pc. / 80 pc.	16x1/2"
18PK-1804-X	10 pc. / 80 pc.	18x1/2"
18PK-1805-X	10 pc. / 50 pc.	18x3/4"
18PK-2004-X	10 pc. / 80 pc.	20x1/2"
18PK-2005-X	10 pc. / 50 pc.	20x3/4"
18PK-2605-X	10 pc. / 50 pc.	26x3/4"
18PK-2606-X	10 pc. / 40 pc.	26x1"
18PK-3206-X	10 pc. / 40 pc.	32x1"
18PK-3207-X	5 pc. / 25 pc.	32x1 1/4"
18PK-4006-X	5 pc. / 25 pc.	40x1"
18PK-4007-X	5 pc. / 25 pc.	40x1 1/4"
18PK-5008-X	1 pc. / 10 pc.	50x1 1/2"
18PK-6310-X	1 pc. / 6 pc.	63x2"

### Type: 18PK-N (CW602)



PK-TOOL p 157

**Straight female adapter**  
**Recht aansluitstuk binnendraad / Schroefbus**  
**Raccord droit femelle**  
**Übergangsfitting IG**

Article number	Bag / Box	Type
18PK-4006-N	5 pc. / 25 pc.	40x1"
18PK-4007-N	5 pc. / 25 pc.	40x1 1/4"
18PK-5008-N	1 pc. / 10 pc.	50x1 1/2"
18PK-6310-N	1 pc. / 6 pc.	63x2"



**Type: 19PK**



Press fit with swivel to eurocone  
 Perskoppeling met wartel en euroconus aansluiting  
 Raccord à sertir avec écrou à visser eurocone  
 Pressfitting mit Drehbar und Eurokonus

Article number	Bag / Box	Type
19PK-1605	10 pc. / 80 pc.	16x3/4"
19PK-2005	10 pc. / 80 pc.	20x3/4"

**Type: 26PK**



Press fitting with swivel and flat sealing  
 Perskoppeling met wartel en vlakke dichting  
 Raccord avec écrou et joint plat  
 Pressfitting mit Drehbar und flach Versiegelung

Article number	Bag / Box	Type
26PK-1605	10 pc. / 80 pc.	16x3/4"
26PK-2005	10 pc. / 80 pc.	20x3/4"

**Type: 26PK (CW617)**



Press fitting with swivel and flat sealing  
 Perskoppeling met wartel en vlakke dichting  
 Raccord avec écrou et joint plat  
 Pressfitting mit Drehbar und flach Versiegelung

Article number	Bag / Box	Type
26PK-4008	5 pc. / 15 pc.	40x1 1/2"
26PK-5010	1 pc. / 10 pc.	50x2"
26PK-6312	1 pc. / 6 pc.	63x2 1/2"

**Type: 27PK**



45° bend  
 Bocht 45°  
 Coude 45°  
 Winkel 45°

Article number	Bag / Box	Type
27PK-2626	5 pc. / 50 pc	26x26
27PK-3232	5 pc. / 30 pc.	32x32
27PK-4040	5 pc. / 25 pc.	40x40
27PK-5050	1 pc. / 10 pc.	50x50
27PK-6363	1 pc. / 5 pc.	63x63

Article number	Box	Type
27PK-7575	1 pc.	75x75
27PK-9090	1 pc.	90x90

For the composition of Super Sizes, see p. 58

- 1
- 2
- 3
- 4
- 5
- 6
- 7
- 8
- 9
- 10
- 11
- 12





## A. PK

1

### Type: 28PK-04

2



3

4

5

6

7

### Type: 53PK

8

9

10

11

12



Bracket wallplate for 2PK, 6PK and 13PK, interaxis 153mm

Muurplaatbeugel voor 2PK, 6PK en 13PK, asafstand 153mm

Attache culasse pour 2PK, 6PK et 13PK, entraxe 153mm

Bügel Wandscheibe für 28PK-2PK1604 und 28PK-6PK-1604, Mitte-zu-Mitte-Abstand

Article number	Box	Type
28PK-04	50 pc.	1/2"

Easy mounting/repair fitting

Eenvoudige montage/reparatie fitting

Raccord montage / réparation facile

Einfache Montage/Reparatur Fitting

Article number	Bag / Box	Type
53PK40	1 pc. / 20 pc.	40x40
53PK50	1 pc. / 9 pc.	50x50
53PK63	1 pc. / 6 pc.	63x63

*for Ø16, 20, 26 and 32: chapter 4, article 52P*



**Type: 1PKW**



Elbow 90°  
Knie 90°  
Coude 90°  
Winkel 90°

Article number	Bag / Box	Type
1PKW-1616	10 pc. / 120 pc.	16x16
1PKW-2020	10 pc. / 80 pc.	20x20
1PKW-2626	5 pc. / 50 pc.	26x26
1PKW-3232	5 pc. / 30 pc.	32x32

**Type: 2PKW (CW617)**



Backplate elbow female  
Sanitair muurplaat binnendraad  
Culasse pour sanitaire  
Sanitär Wandscheibe IG

Article number	Bag / Box	Type
2PKW-1604	10 pc. / 50 pc.	16x1/2" (56 mm)
2PKW-2004	10 pc. / 50 pc.	20x1/2" (56 mm)
2PKW-2005	5 pc. / 30 pc.	20x3/4" (56 mm)
2PKW-2605	5 pc. / 30 pc.	26x3/4" (56 mm)

**Type: 2PKW-X (INOX)**



Backplate elbow female  
Sanitair muurplaat binnendraad  
Culasse pour sanitaire  
Sanitär Wandscheibe IG

Article number	Bag / Box	Type
2PKW-2004-X	10 pc. / 50 pc.	20x1/2" (56 mm)
2PKW-2005-X	5 pc. / 30 pc.	20x3/4" (56 mm)
2PKW-2605-X	5 pc. / 30 pc.	26x3/4" (56 mm)

**Type: 2PKW-N (CW602)**



Backplate elbow female  
Sanitair muurplaat binnendraad  
Culasse pour sanitaire  
Sanitär Wandscheibe IG

Article number	Bag / Box	Type
2PKW-1604-N	10 pc. / 50 pc.	16x1/2" (56 mm)
2PKW-2004-N	10 pc. / 50 pc.	20x1/2" (56 mm)
2PKW-2005-N	5 pc. / 30 pc.	20x3/4" (56 mm)
2PKW-2605-N	5 pc. / 30 pc.	26x3/4" (56 mm)

**Type: 2PKW-K (CW617)**



Backplate elbow female, short model  
Sanitair muurplaat binnendraad, kort model  
Culasse pour sanitaire, modèle court  
Sanitär Wandscheibe IG, kurzes Modell

Article number	Bag / Box	Type
2PKW-1604K	10 pc. / 50 pc.	16x1/2" (40 mm)

- 1
- 2
- 3
- 4
- 5
- 6
- 7
- 8
- 9
- 10
- 11
- 12



## B. PKW

### Type: 2PKW-K-X (INOX)



Backplate elbow female, short model,  
Sanitair muurplaat binnendraad, kort model  
Culasse pour sanitaire, modèle court  
Sanitär Wandscheibe IG, kurzes Modell

Article number	Bag / Box	Type
2PKW-1604K-X	10 pc. / 50 pc.	16x1/2" (40 mm)

### Type: 2PKW-K-N (CW602)



Backplate elbow female, short model  
Sanitair muurplaat binnendraad, kort model  
Culasse pour sanitaire, modèle court  
Sanitär Wandscheibe IG, kurzes Modell

Article number	Bag / Box	Type
2PKW-1604K-N	10 pc. / 50 pc.	16x1/2" (40 mm)

Accessory 2PK & 2PK-K: galvanised bracket plate - see page 158



PLP-P-PK



PLF-P-PK

### Type: 2PKW-X (INOX)



Backplate elbow female, short model  
Sanitair muurplaat binnendraad, kort model  
Culasse pour sanitaire, modèle court  
Sanitär Wandscheibe IG, kurzes Modell

Article number	Bag / Box	Type
2PKW-1604-X	10 pc. / 50 pc.	16x1/2" (40 mm)

### PKW (CW617)



Double backplate elbow female, short model  
Sanitair muurplaat binnendraad dubbel, laag  
Culasse double pour sanitaire, modèle court  
Sanitär Wandscheibe doppelt IG, kurzes Modell

Article number	Bag / Box	Type
3PKW-160416	10 pc. / 30 pc.	16x1/2"x16 (40 mm)
3PKW-200420	10 pc. / 30 pc.	20x1/2"x20 (40 mm)

### Type: 3PKW-K-X (INOX)



Double backplate elbow female, short model  
Sanitair muurplaat binnendraad dubbel, laag  
Culasse double pour sanitaire, modèle court  
Sanitär Wandscheibe doppelt IG, kurzes Modell

Article number	Bag / Box	Type
3PKW-160416-X	10 pc. / 30 pc.	16x1/2"x16 (40 mm)
3PKW-200420-X	10 pc. / 30 pc.	20x1/2"x20 (40 mm)



**Type: 3PKW-N (CW602)**



Double backplate elbow female, short model  
 Sanitair muurplaat binnendraad dubbel, laag  
 Culasse double pour sanitaire, modèle court  
 Sanitär Wandscheibe doppelt IG, kurzes Modell

Article number	Bag / Box	Type
3PKW-160416-N	10 pc. / 30 pc.	16x1/2"x16 (40 mm)
3PKW-200420-N	10 pc. / 30 pc.	20x1/2"x20 (40 mm)

**Type: 5PKW (CW617)**



Bend 90° male adapter  
 Knie 90° buitendraad  
 Coude 90° mâle  
 Winkel 90° AG

Article number	Bag / Box	Type
5PKW-1604	10 pc. / 60 pc.	16x1/2"
5PKW-2004	10 pc. / 60 pc.	20x1/2"
5PKW-2005	10 pc. / 50 pc.	20x3/4"
5PKW-2605	10 pc. / 40 pc.	26x3/4"
5PKW-3206	5 pc. / 20 pc.	32x1"



PK-TOOL p 157

**Type: 5PKW-N (CW602)**



Bend 90° male adapter  
 Knie 90° buitendraad  
 Coude 90° mâle  
 Winkel 90° AG

Article number	Bag / Box	Type
5PKW-1604-N	10 pc. / 60 pc.	16x1/2"
5PKW-2004-N	10 pc. / 60 pc.	20x1/2"
5PKW-2005-N	10 pc. / 50 pc.	20x3/4"
5PKW-2605-N	10 pc. / 40 pc.	26x3/4"
5PKW-3206-N	5 pc. / 20 pc.	32x1"



PK-TOOL p 157

**Type: 6PKW (CW617)**



Bend 90° female adapter  
 Knie 90° binnendraad  
 Coude 90° femelle  
 Winkel 90° IG

Article number	Bag / Box	Type
6PKW-1603	10 pc. / 60 pc.	16x3/8"
6PKW-1604	10 pc. / 60 pc.	16x1/2"
6PKW-2004	10 pc. / 60 pc.	20x1/2"
6PKW-2005	10 pc. / 50 pc.	20x3/4"
6PKW-2605	10 pc. / 50 pc.	26x3/4"
6PKW-3206	5 pc. / 20 pc.	32x1"



PK-TOOL p 157

- 1
- 2
- 3
- 4
- 5
- 6
- 7
- 8
- 9
- 10
- 11
- 12



## B. PKW

### Type: 6PKW-X (INOX)



Bend 90° female adapter  
Knie 90° binnendraad  
Coude 90° femelle  
Winkel 90° IG

Article number	Bag / Box	Type
6PKW-1604-X	10 pc. / 60 pc.	16x1/2"
6PKW-2004-X	10 pc. / 60 pc.	20x1/2"
6PKW-2005-X	10 pc. / 50 pc.	20x3/4"
6PKW-2605-X	10 pc. / 50 pc.	26x3/4"
6PKW-3206-X	5 pc. / 20 pc.	32x1"

### Type: 6PKW-N (CW602)



PK-TOOL p 157

Bend 90° female adapter  
Knie 90° binnendraad  
Coude 90° femelle  
Winkel 90° IG

Article number	Bag / Box	Type
6PKW-1603-N	10 pc. / 60 pc.	16x3/8"
6PKW-1604-N	10 pc. / 60 pc.	16x1/2"
6PKW-2004-N	10 pc. / 60 pc.	20x1/2"
6PKW-2005-N	10 pc. / 50 pc.	20x3/4"
6PKW-2605-N	10 pc. / 50 pc.	26x3/4"
6PKW-3206-N	5 pc. / 20 pc.	32x1"

Type: 9PKW

### Type: 9PKW



T-piece  
T-stuk  
Pièce en T  
T-Stück

Article number	Bag / Box	Type
9PKW-161616	10 pc. / 60 pc.	16x16x16
9PKW-202020	10 pc. / 50 pc.	20x20x20
9PKW-262626	5 pc. / 30 pc.	26x26x26
9PKW-323232	5 pc. / 15 pc.	32x32x32

### Type: 10PKW



T-reduced centre  
T-verlopend  
T-réduit  
T-reduziert

Article number	Bag / Box	Type
10PKW-201620	10 pc. / 50 pc.	20x16x20
10PKW-261626	5 pc. / 30 pc.	26x16x26
10PKW-262026	5 pc. / 30 pc.	26x20x26
10PKW-321632	5 pc. / 25 pc.	32x16x32
10PKW-322032	5 pc. / 25 pc.	32x20x32
10PKW-322632	5 pc. / 20 pc.	32x26x32





**Type: 11PKW**



T-branch and line reduced  
 T-2x verlopend  
 T-2x réduit  
 T-2x reduziert

Article number	Bag / Box	Type
11PKW-201616	10 pc. / 50 pc.	20x16x16
11PKW-202016	10 pc. / 50 pc.	20x20x16
11PKW-261616	10 pc. / 50 pc.	26x16x16
11PKW-261620	5 pc. / 30 pc.	26x16x20
11PKW-262016	5 pc. / 30 pc.	26x20x16
11PKW-262020	5 pc. / 30 pc.	26x20x20
11PKW-262616	5 pc. / 30 pc.	26x26x16
11PKW-262620	5 pc. / 30 pc.	26x26x20
11PKW-322026	5 pc. / 20 pc.	32x20x26
11PKW-322626	5 pc. / 20 pc.	32x26x26

**Type: 12PKW**



T-enlarged branch  
 T-vergroot  
 T-agrandi  
 T-erweitert

Article number	Bag / Box	Type
12PKW-162016	10 pc. / 50 pc.	16x20x16
12PKW-202620	5 pc. / 30 pc.	20x26x20
12PKW-263226	5 pc. / 20 pc.	26x32x26

**Type: 13PKW (CW617)**



PK-TOOL p 157

T-female centre  
 T-binnendraad  
 T-femelle  
 T-IG

Article number	Bag / Box	Type
13PKW-160416	10 pc. / 50 pc.	16x1/2"x16
13PKW-200420	10 pc. / 50 pc.	20x1/2"x20
13PKW-200520	10 pc. / 30 pc.	20x3/4"x20
13PKW-260426	5 pc. / 30 pc.	26x1/2"x26
13PKW-260526	5 pc. / 30 pc.	26x3/4"x26
13PKW-320532	5 pc. / 15 pc.	32x3/4"x32
13PKW-320632	5 pc. / 10 pc.	32x1"x32

- 1
- 2
- 3
- 4
- 5
- 6
- 7
- 8
- 9
- 10
- 11
- 12



## B. PKW

### Type: 13PKW-X (INOX)



T-female centre  
T-binnendraad  
T-femelle  
T-IG

Article number	Bag / Box	Type
13PKW-160416-X	10 pc. / 50 pc.	16x1/2"x16
13PKW-200420-X	10 pc. / 50 pc.	20x1/2"x20
13PKW-200520-X	10 pc. / 30 pc.	20x3/4"x20
13PKW-260426-X	5 pc. / 30 pc.	26x1/2"x26
13PKW-260526-X	5 pc. / 30 pc.	26x3/4"x26
13PKW-260526-X	5 pc. / 30 pc.	26x3/4"x26
13PKW-320532-X	5 pc. / 15 pc.	32x3/4"x32
13PKW-320632-X	5 pc. / 10 pc.	32x1"x32

### Type: 13PKW-N (CW602)



PK-TOOL p 157

T-female centre  
T-binnendraad  
T-femelle  
T-IG

Article number	Bag / Box	Type
13PKW-160416-N	10 pc. / 50 pc.	16x1/2"x16
13PKW-200420-N	10 pc. / 50 pc.	20x1/2"x20
13PKW-200520-N	10 pc. / 30 pc.	20x3/4"x20
13PKW-260426-N	5 pc. / 30 pc.	26x1/2"x26
13PKW-260526-N	5 pc. / 30 pc.	26x3/4"x26
13PKW-260526-N	5 pc. / 30 pc.	26x3/4"x26
13PKW-320532-N	5 pc. / 15 pc.	32x3/4"x32
13PKW-320632-N	5 pc. / 10 pc.	32x1"x32

### Type: 14PKW (CW617)



PK-TOOL p 157

T-male centre  
T-buitendraad  
T-mâle  
T-AG

Article number	Bag / Box	Type
14PKW-160416	10 pc. / 50 pc.	16x1/2"x16
14PKW-200420	10 pc. / 40 pc.	20x1/2"x20
14PKW-200520	10 pc. / 30 pc.	20x3/4"x20
14PKW-320532	5 pc. / 15 pc.	32x3/4"x32

### Type: 14PKW-N (CW602)



PK-TOOL p 157

T-male centre  
T-buitendraad  
T-mâle  
T-AG

Article number	Bag / Box	Type
14PKW-160416-N	10 pc. / 50 pc.	16x1/2"x16
14PKW-200420-N	10 pc. / 40 pc.	20x1/2"x20
14PKW-200520-N	10 pc. / 30 pc.	20x3/4"x20



**Type: 16PKW**



**Reducing coupling**  
**Verloopstuk**  
**Réduction**  
**Kupplung-reduziert**

Article number	Bag / Box	Type
16PKW-2016	10 pc. / 100 pc.	20x16
16PKW-2616	5 pc. / 60 pc.	26x16
16PKW-2620	5 pc. / 50 pc.	26x20
16PKW-3216	5 pc. / 50 pc.	32x16
16PKW-3220	5 pc. / 40 pc.	32x20
16PKW-3226	5 pc. / 40 pc.	32x26

**Type: 17PKW (CW617)**



PK-TOOL p 157

**Straight male adapter**  
**Recht aansluitstuk buitendraad / Puntstuk**  
**Raccord droit mâle**  
**Übergangsfitting AG**

Article number	Bag / Box	Type
17PKW-1604	10 pc. / 80 pc.	16x1/2"
17PKW-2004	10 pc. / 80 pc.	20x1/2"
17PKW-2005	10 pc. / 50 pc.	20x3/4"
17PKW-2605	10 pc. / 50 pc.	26x3/4"
17PKW-2606	10 pc. / 40 pc.	26x1"
17PKW-3206	10 pc. / 40 pc.	32x1"
17PKW-3207	5 pc. / 25 pc.	32 x 1 1/4"

**Type: 17PKW-N (CW602)**



**Straight male adapter**  
**Recht aansluitstuk buitendraad / Puntstuk**  
**Raccord droit mâle**  
**Übergangsfitting AG**

Article number	Bag / Box	Type
17PKW-1604-N	10 pc. / 80 pc.	16x1/2"
17PKW-2004-N	10 pc. / 80 pc.	20x1/2"
17PKW-2005-N	10 pc. / 50 pc.	20x3/4"
17PKW-2605-N	10 pc. / 50 pc.	26x3/4"
17PKW-2606-N	10 pc. / 40 pc.	26x1"
17PKW-3206-N	10 pc. / 40 pc.	32x1"
17PKW-3207-N	5 pc. / 25 pc.	32 x 1 1/4"

**18PKW (CW617)**



PK-TOOL p 157

**Straight female adapter**  
**Recht aansluitstuk binnendraad / Schroefbus**  
**Raccord droit femelle**  
**Übergangsfitting IG**

Article number	Bag / Box	Type
18PKW-1604	10 pc. / 80 pc.	16x1/2"
18PKW-2004	10 pc. / 80 pc.	20x1/2"
18PKW-2005	10 pc. / 50 pc.	20x3/4"
18PKW-2605	10 pc. / 50 pc.	26x3/4"
18PKW-2606	10 pc. / 40 pc.	26x1"
18PKW-3206	10 pc. / 40 pc.	32x1"
18PKW-3207	5 pc. / 25 pc.	32x1 1/4"



## B. PKW

### Type: 18PKW-X (INOX)



**Straight female adapter**  
**Recht aansluitstuk binnendraad / Schroefbus**  
**Raccord droit femelle**  
**Übergangsfitting IG**

Article number	Bag / Box	Type
18PKW-1604-X	10 pc. / 80 pc.	16x1/2"
18PKW-2004-X	10 pc. / 80 pc.	20x1/2"
18PKW-2005-X	10 pc. / 50 pc.	20x3/4"
18PKW-2605-X	10 pc. / 50 pc.	26x3/4"
18PKW-2606-X	10 pc. / 40 pc.	26x1"
18PKW-3206-X	10 pc. / 40 pc.	32x1"
18PKW-3207-X	5 pc. / 25 pc.	32x1 1/4"

### Type: 18PKW-N (CW602)



PK-TOOL p 157

**Straight female adapter**  
**Recht aansluitstuk binnendraad / Schroefbus**  
**Raccord droit femelle**  
**Übergangsfitting IG**

Article number	Bag / Box	Type
18PKW-1604-N	10 pc. / 80 pc.	16x1/2"
18PKW-2004-N	10 pc. / 80 pc.	20x1/2"
18PKW-2005-N	10 pc. / 50 pc.	20x3/4"
18PKW-2605-N	10 pc. / 50 pc.	26x3/4"
18PKW-2606-N	10 pc. / 40 pc.	26x1"
18PKW-3206-N	10 pc. / 40 pc.	32x1"
18PKW-3207-N	5 pc. / 25 pc.	32x1 1/4"

### Type: 19PKW



**Press fitting to eurocone**  
**Perskoppeling met euroconus aansluiting**  
**Raccord avec raccord à visser eurocone**  
**Pressfitting mit Eurokonus**

Article number	Bag / Box	Type
19PKW-1605	10 pc. / 80 pc.	16x3/4"
19PKW-2005	10 pc. / 80 pc.	20x3/4"

### Type: 26PKW



**Press fitting with flat sealing**  
**Perskoppeling met vlakke dichting**  
**Raccord avec etachéité plate**  
**Pressfitting mit flach Versiegelung**

Article number	Bag / Box	Type
26PKW-1605	10 pc. / 80 pc.	16x3/4"
26PKW-2005	10 pc. / 80 pc.	20x3/4"

### Type: 27PKW



**45° bend**  
**Bocht 45°**  
**Coude 45°**  
**Winkel 45°**

Article number	Bag / Box	Type
27PKW-2626	5 pc. / 50 pc.	26x26
27PKW-3232	5 pc. / 30 pc.	32x32



Gas: only allowed in countries where has been a HENCO GAS testing + certificate is available! (See [www.henco.be](http://www.henco.be))  
 Gas: enkel toegelaten in landen waar er een HENCO GAS keur is + een certificaat voorhanden is! (zie [www.henco.be](http://www.henco.be))  
 Gaz: seulement permis dans des pays où le contrôle a eu lieu + certificat est disponible! (Consultez [www.henco.be](http://www.henco.be))  
 Gas: nur zugelassen in Länder wo HENCO GAS Prüfung geschehen ist + Zertifikat vorhanden ist! (Siehe [www.henco.be](http://www.henco.be))

Henco press fittings synthetic for gas in combination with standard pipe gas, see page 17



**Type: 1PKG**



Elbow 90°  
 Knie 90°  
 Coude 90°  
 Winkel 90°

Article number	Bag / Box	Type
1PKG-1616	10 pc. / 120 pc.	16x16
1PKG-2020	10 pc. / 80 pc.	20x20
1PKG-2626	5 pc. / 50 pc.	26x26
1PKG-3232	5 pc. / 30 pc.	32x32
1PKG-4040	5 pc. / 20 pc.	40x40

**Type: 2PKG**



Backplate elbow female  
 Muurplaat binnendraad  
 Culasse femelle  
 Wandscheibe IG

Article number	Bag / Box	Type
2PKG-1603	10 pc. / 50 pc.	16x3/8" (56 mm)
2PKG-1604BP *	10 pc. / 50 pc.	16x1/2" (56 mm)
2PKG-2004BP *	10 pc. / 50 pc.	20x1/2" (56 mm)
2PKG-2005	5 pc. / 30 pc.	20x3/4" (56 mm)
2PKG-2605	5 pc. / 30 pc.	26x3/4" (56 mm)

\* With black plug BP04 1/2"

**Type: 2PKG-K**



Backplate elbow female, short model  
 Muurplaat binnendraad, laag  
 Culasse femelle, modèle court  
 Wandscheibe IG, kurzes Modell

Article number	Bag / Box	Type
2PKG-1604KBP *	10 pc. / 50 pc.	16x1/2" (40 mm)

\* With black plug BP04 1/2"





## C. PKG

### Type: 5PKG



PK-TOOL p 157

**Bend 90° male adapter**  
**Knie 90° buitendraad**  
**Coude 90° mâle**  
**Winkel 90° AG**

Article number	Bag / Box	Type
5PKG-1604	10 pc. / 60 pc.	16x1/2"
5PKG-2004	10 pc. / 60 pc.	20x1/2"
5PKG-2005	10 pc. / 50 pc.	20x3/4"
5PKG-2605	10 pc. / 40 pc.	26x3/4"
5PKG-3206	5 pc. / 20 pc.	32x1"
5PKG-4007	5 pc. / 15 pc.	40x1 1/4"

### Type: 6PKG



PK-TOOL p 157

**Bend 90° female adapter**  
**Knie 90° binnendraad**  
**Coude 90° femelle**  
**Winkel 90° IG**

Article number	Bag / Box	Type
6PKG-1604BP *	10 pc. / 60 pc.	16x1/2"
6PKG-2004BP *	10 pc. / 60 pc.	20x1/2"
6PKG-2005	10 pc. / 50 pc.	20x3/4"
6PKG-2605	10 pc. / 50 pc.	26x3/4"
6PKG-3206	5 pc. / 20 pc.	32x1"
6PKG-4007	5 pc. / 15 pc.	40x1 1/4"

\* With black plug BP04 1/2"

### Type: 9PKG



**T-piece**  
**T-stuk**  
**Pièce en T**  
**T-Stück**

Article number	Bag / Box	Type
9PKG-161616	10 pc. / 60 pc.	16x16x16
9PKG-202020	10 pc. / 50 pc.	20x20x20
9PKG-262626	5 pc. / 30 pc.	26x26x26
9PKG-323232	5 pc. / 15 pc.	32x32x32
9PKG-404040	5 pc. / 10 pc.	40x40x40



**Type: 10PKG**



T-reduced centre  
T-verlopend  
Pièce en T réduit  
T-reduziert

Article number	Bag / Box	Type
10PKG-201620	10 pc. / 50 pc.	20x16x20
10PKG-261626	5 pc. / 30 pc.	26x16x26
10PKG-262026	5 pc. / 30 pc.	26x20x26
10PKG-321632	5 pc. / 25 pc.	32x16x32
10PKG-322032	5 pc. / 25 pc.	32x20x32
10PKG-322632	5 pc. / 20 pc.	32x26x32
10PKG-401640	5 pc. / 15 pc.	40x16x40
10PKG-402040	5 pc. / 15 pc.	40x20x40
10PKG-402640	5 pc. / 15 pc.	40x26x40
10PKG-403240	5 pc. / 10 pc.	40x32x40

**Type: 11PKG**



T-branch and line reduced  
T-2X verlopend  
Pièce en T 2X réduit  
T-2X reduziert

Article number	Bag / Box	Type
11PKG-201616	10 pc. / 50 pc.	20x16x16
11PKG-202016	10 pc. / 50 pc.	20x20x16
11PKG-261620	5 pc. / 30 pc.	26x16x20
11PKG-262016	5 pc. / 30 pc.	26x20x16
11PKG-262020	5 pc. / 30 pc.	26x20x20
11PKG-262616	5 pc. / 30 pc.	26x26x16
11PKG-262620	5 pc. / 30 pc.	26x26x20
11PKG-322026	5 pc. / 20 pc.	32x20x26
11PKG-322626	5 pc. / 20 pc.	32x26x26
11PKG-402032	5 pc. / 15 pc.	40x20x32
11PKG-402632	5 pc. / 15 pc.	40x26x32
11PKG-403232	5 pc. / 10 pc.	40x32x32
11PKG-404026	5 pc. / 10 pc.	40x40x26
11PKG-404032	5 pc. / 10 pc.	40x40x32

**Type: 12PKG**



T-enlarged branch  
T-vergroot  
Pièce en T agrandi  
T-erweitert

Article number	Bag / Box	Type
12PKG-162016	10 pc. / 50 pc.	16x20x16
12PKG-202620	5 pc. / 30 pc.	20x26x20
12PKG-263226	5 pc. / 20 pc.	26x32x26
12PKG-324032	5 pc. / 15 pc.	32x40x32

- 1
- 2
- 3
- 4
- 5
- 6
- 7
- 8
- 9
- 10
- 11
- 12



## C. PKG

### Type: 13PKG



PK-TOOL p 157

T-female branch  
T-binnendraad  
Pièce en T femelle  
T-IG

Article number	Bag / Box	Type
13PKG-160416BP *	10 pc. / 50 pc.	16x1/2"x16
13PKG-200420BP *	10 pc. / 50 pc.	20x1/2"x20
13PKG-200520	10 pc. / 30 pc.	20x3/4"x20
13PKG-260420BP *	5 pc. / 30 pc.	26x1/2"x20
13PKG-260426BP *	5 pc. / 30 pc.	26x1/2"x26
13PKG-260526	5 pc. / 30 pc.	26x3/4"x26
13PKG-320532	5 pc. / 15 pc.	32x3/4"x32
13PKG-320632	5 pc. / 10 pc.	32x1"x32
13PKG-320732	5 pc. / 10 pc.	32x1 1/4"x32
13PKG-400640	5 pc. / 10 pc.	40x1"x40
13PKG-400740	5 pc. / 10 pc.	40x1 1/4"x40

\* With black plug BP04 1/2"

### Type: 14PKG



PK-TOOL p 157

T-male branch  
T-buitendraad  
Pièce en T mâle  
T-AG

Article number	Bag / Box	Type
14PKG-160416	10 pc. / 50 pc.	16x1/2"x16
14PKG-200420	10 pc. / 40 pc.	20x1/2"x20
14PKG-260426	5 pc. / 30 pc.	26x1/2"x26
14PKG-260626	5 pc. / 20 pc.	26x1"x26

### Type: 15PKG



Straight coupling  
Doorverbinder recht / perssok  
Manchon  
Kupplung

Article number	Bag / Box	Type
15PKG-1616	10 pc. / 150 pc.	16x16
15PKG-2020	10 pc. / 80 pc.	20x20
15PKG-2626	5 pc. / 50 pc.	26x26
15PKG-3232	5 pc. / 30 pc.	32x32
15PKG-4040	5 pc. / 25 pc.	40x40



**Type: 16PKG**



**Reducing coupling**  
**Verloopstuk**  
**Réduction**  
**Kupplung-reduziert**

Article number	Bag / Box	Type
16PKG-2016	10 pc. / 100 pc.	20x16
16PKG-2616	5 pc. / 60 pc.	26x16
16PKG-2620	5 pc. / 50 pc.	26x20
16PKG-3216	5 pc. / 50 pc.	32x16
16PKG-3220	5 pc. / 40 pc.	32x20
16PKG-3226	5 pc. / 40 pc.	32x26
16PKG-4026	5 pc. / 30 pc.	40x26
16PKG-4032	5 pc. / 25 pc.	40x32

**Type: 17PKG**



PK-TOOL p 157

**Straight male adapter**  
**Recht aansluitstuk buitendraad / Puntstuk**  
**Raccord droit mâle**  
**Übergangsfitting AG**

Article number	Bag / Box	Type
17PKG-1604	10 pc. / 80 pc.	16x1/2"
17PKG-2004	10 pc. / 80 pc.	20x1/2"
17PKG-2005	10 pc. / 50 pc.	20x3/4"
17PKG-2605	10 pc. / 50 pc.	26x3/4"
17PKG-2606	10 pc. / 40 pc.	26x1"
17PKG-3206	10 pc. / 40 pc.	32x1"
17PKG-3207	5 pc. / 25 pc.	32x1 1/4"
17PKG-4006	5 pc. / 25 pc.	40x1"
17PKG-4007	5 pc. / 25 pc.	40x1 1/4"

**Type: 18PKG**



PK-TOOL p 157

**Straight female adapter**  
**Recht aansluitstuk binnendraad / Schroefbus**  
**Raccord droit femelle**  
**Übergangsfitting IG**

Article number	Bag / Box	Type
18PKG-1604	10 pc. / 80 pc.	16x1/2"
18PKG-2004	10 pc. / 80 pc.	20x1/2"
18PKG-2005	10 pc. / 50 pc.	20x3/4"
18PKG-2605	10 pc. / 50 pc.	26x3/4"
18PKG-2606	10 pc. / 40 pc.	26x1"
18PKG-3206	10 pc. / 40 pc.	32x1"
18PKG-3207	5 pc. / 25 pc.	32x1 1/4"
18PKG-4006	5 pc. / 25 pc.	40x1"
18PKG-4007	5 pc. / 25 pc.	40x1 1/4"

**Type: 27PKG**



**45° bend**  
**Bocht 45°**  
**Coude 45°**  
**Winkel 45°**

Article number	Bag / Box	Type
27PKG-4040	5 pc. / 25 pc.	40x40

- 1
- 2
- 3
- 4
- 5
- 6
- 7
- 8
- 9
- 10
- 11
- 12



## D. PKS

Henco press fittings synthetic for Sprinkler in combination with standard pipe sprinkler, see page 18



Sprinkler: only allowed in countries where a HENCO Sprinkler certificate is available! (see [www.henco.be](http://www.henco.be))  
 Sprinkler: enkel toegelaten in landen waar een HENCO Sprinkler certificaat voorhanden is! (zie [www.henco.be](http://www.henco.be))  
 Sprinkler: seulement permis dans des pays où le HENCO Sprinkler certificat est disponible! (consultez [www.henco.be](http://www.henco.be))  
 Sprinkler: nur zugelassen in Länder wo HENCO Sprinkler Zertifikat vorhanden ist! (siehe [www.henco.be](http://www.henco.be))

### Type: 1PKS



Elbow 90°

Bocht 90°

Coude 90°

Winkel 90°

Article number	Bag / Box	Type
1PKS-3232	5 pc. / 30 pc.	32 x 32
1PKS-4040	5 pc. / 20 pc.	40 x 40
1PKS-5050	1 pc. / 8 pc.	50x 50
1PKS-6363	1 pc. / 6 pc.	63 x 63

### Type: 5PKS (CW617)



Elbow 90° male adapter

Bocht 90° buitendraad

Coude 90° mâle

Winkel 90° AG

Article number	Bag / Box	Type
5PKS-3206	5 pc. / 20 pc.	32 x 1"
5PKS-4007	3 pc. / 15 pc.	40 x 1,1/4"
5PKS-5007	1 pc. / 10 pc.	50x 1,1/4"
5PKS-5008	1 pc. / 8 pc.	50x 1,1/2"
5PKS-6310	1 pc. / 4 pc.	63 x 2"

### Type: 5PKS-N (CW602)



Elbow 90° male adapter

Bocht 90° buitendraad

Coude 90° mâle

Winkel 90° AG

Article number	Bag / Box	Type
5PKS-3206-N	5 pc. / 20 pc.	32 x 1"
5PKS-4007-N	5 pc. / 15 pc.	40 x 1,1/4"
5PKS-5007-N	1 pc. / 8 pc.	50x 1,1/4"
5PKS-5008-N	1 pc. / 8 pc.	50x 1,1/2"
5PKS-6310-N	1 pc. / 4 pc.	63 x 2"

### Type: 6PKS (CW617)



Elbow 90° female adapter

Bocht 90° binnendraad

Coude 90° femelle

Winkel 90° IG

Article number	Bag / Box	Type
6PKS-3204	5 pc. / 20 pc.	32 x 1/2"
6PKS-3206	5 pc. / 20 pc.	32 x 1"
6PKS-4004	3 pc. / 15 pc.	40 x 1/2"
6PKS-4007	5 pc. / 15 pc.	40 x 1,1/4"
6PKS-5004	1 pc. / 8 pc.	50x 1/2"
6PKS-5007	1 pc. / 8 pc.	50x 1,1/4"
6PKS-5008	1 pc. / 8 pc.	50x 1,1/2"
6PKS-6304	1 pc. / 4 pc.	63 x 1/2"
6PKS-6310	1 pc. / 4 pc.	63 x 2"





**Type: 6PKS-N (CW602)**



Elbow 90° female adapter  
Bocht 90° binnendraad  
Coude 90° femelle  
Winkel 90° IG

Article number	Bag / Box	Type
6PKS-3204-N	5 pc. / 20 pc.	32 x 1/2"
6PKS-3206-N	5 pc. / 20 pc.	32 x 1"
6PKS-4004-N	3 pc. / 15 pc.	40 x 1/2"
6PKS-4007-N	5 pc. / 15 pc.	40 x 1,1/4"
6PKS-5004-N	1 pc. / 8 pc.	50x 1/2"
6PKS-5007-N	1 pc. / 8 pc.	50x 1,1/4"
6PKS-5008-N	1 pc. / 8 pc.	50x 1,1/2"
6PKS-6304-N	1 pc. / 4 pc.	63 x 1/2"
6PKS-6310-N	1 pc. / 4 pc.	63 x 2"

**Type: 9PKS**



T-piece  
T-stuk  
Pièce en T  
T-Stück

Article number	Bag / Box	Type
9PKS-323232	5 pc. / 15 pc.	32 x 32 x 32
9PKS-404040	5 pc. / 10 pc.	40 x 40 x 40
9PKS-505050	1 pc. / 6 pc.	50 x 50 x 50
9PKS-636363	1 pc. / 3 pc.	63 x 63 x 63

**Type: 10PKS**



T-reduced centre  
T-verlopend  
Pièce en T réduit  
T-reduziert

Article number	Bag / Box	Type
10PKS-322632	5 pc. / 20 pc.	32 x 26 x 32
10PKS-402640	5 pc. / 15 pc.	40 x 26 x 40
10PKS-403240	5 pc. / 10 pc.	40 x 32 x 40
10PKS-503250	1 pc. / 8 pc.	50 x 32 x 50
10PKS-504050	1 pc. / 6 pc.	50 x 40 x 50
10PKS-633263	1 pc. / 3 pc.	63 x 32 x 63
10PKS-634063	1 pc. / 3 pc.	63 x 40 x 63
10PKS-635063	1 pc. / 3 pc.	63 x 50 x 63

**Type: 11PKS**



T-branch and line reduced  
T-2x verlopend  
Pièce en T 2x réduit  
T-2x reduziert

Article number	Bag / Box	Type
11PKS-403232	5 pc. / 10 pc.	40 x 32 x 32
11PKS-404032	5 pc. / 10 pc.	40 x 40 x 32
11PKS-503240	1 pc. / 10 pc.	50 x 32 x 40
11PKS-504040	1 pc. / 8 pc.	50 x 40 x 40



## D. PKS

1

### Type: 12PKS

2



T-enlarged branch

T-vergroot

Pièce en T agrandi

T-erwittert

Article number	Bag / Box	Type
12PKS-324032	5 pc. / 15 pc.	32 x 40 x 32
12PKS-405040	1 pc. / 8 pc.	40 x 50 x 40

4

5

6

7

### Type: 13PKS (CW617)

8



T-female branch

T-binnendraad

Pièce en T femelle

T-IG

Article number	Bag / Box	Type
13PKS-320432	5 pc. / 20 pc.	32 x 1/2" x 32
13PKS-320532	5 pc. / 15 pc.	32 x 3/4" x 32
13PKS-320632	5 pc. / 10 pc.	32 x 1" x 32
13PKS-320732	5 pc. / 10 pc.	32 x 1,1/4" x 32
13PKS-400440	5 pc. / 10 pc.	40 x 1/2" x 40
13PKS-400640	5 pc. / 10 pc.	40 x 1" x 40
13PKS-400740	5 pc. / 10 pc.	40 x 1,1/4" x 40
13PKS-500450	1 pc. / 4 pc.	50 x 1/2" x 50
13PKS-500550	1 pc. / 4 pc.	50 x 3/4" x 50
13PKS-500850	1 pc. / 4 pc.	50 x 1,1/2" x 50
13PKS-630463	1 pc. / 2 pc.	63 x 1/2" x 63
13PKS-631063	1 pc. / 2 pc.	63 x 2" x 63

10

11

12

### Type: 13PKS-N (CW602)



T-female branch

T-binnendraad

Pièce en T femelle

T-IG

Article number	Bag / Box	Type
13PKS-320432-N	5 pc. / 20 pc.	32 x 1/2" x 32
13PKS-320532-N	5 pc. / 15 pc.	32 x 3/4" x 32
13PKS-320632-N	5 pc. / 10 pc.	32 x 1" x 32
13PKS-320732-N	5 pc. / 10 pc.	32 x 1,1/4" x 32
13PKS-400440-N	5 pc. / 10 pc.	40 x 1/2" x 40
13PKS-400640-N	5 pc. / 10 pc.	40 x 1" x 40
13PKS-400740-N	5 pc. / 10 pc.	40 x 1,1/4" x 40
13PKS-500450-N	1 pc. / 4 pc.	50 x 1/2" x 50
13PKS-500550-N	1 pc. / 4 pc.	50 x 3/4" x 50
13PKS-500850-N	1 pc. / 4 pc.	50 x 1,1/2" x 50
13PKS-630463-N	1 pc. / 2 pc.	63 x 1/2" x 63
13PKS-631063-N	1 pc. / 2 pc.	63 x 2" x 63



**Type: 14PKS (CW617)**



T-male branch  
T-buitendraad  
Pièce en T male  
T-AG

Article number	Bag / Box	Type
14PKS-320532	5 pc. / 15 pc.	32 x 3/4" x 32
14PKS-400640	5 pc. / 10 pc.	40 x 1" x 40
14PKS-400740	5 pc. / 10 pc.	40 x 1,1/4" x 40
14PKS-500850	1 pc. / 5 pc.	50 x 1,1/2" x 50
14PKS-631063	1 pc. / 2 pc.	63 x 2" x 63

**Type: 14PKS-N (CW602)**



T-male branch  
T-buitendraad  
Pièce en T male  
T-AG

Article number	Bag / Box	Type
14PKS-320532-N	5 pc. / 15 pc.	32 x 3/4" x 32
14PKS-400640-N	5 pc. / 10 pc.	40 x 1" x 40
14PKS-400740-N	5 pc. / 10 pc.	40 x 1,1/4" x 40
14PKS-500850-N	1 pc. / 5 pc.	50 x 1,1/2" x 50
14PKS-631063-N	1 pc. / 2 pc.	63 x 2" x 63

**Type: 15PKS**



Coupling  
Doorverbinder / perssok  
Manchon  
Kupplung

Article number	Bag / Box	Type
15PKS-3232	5 pc. / 30 pc.	32 x 32
15PKS-4040	5 pc. / 25 pc.	40 x 40
15PKS-5050	1 pc. / 12 pc.	50 x 50
15PKS-6363	1 pc. / 9 pc.	63 x 63

**Type: 16PKS**



Reducing coupling  
Verloopstuk  
Réduction  
Kupplung-reduziert

Article number	Bag / Box	Type
16PKS-4032	5 pc. / 25 pc.	40 x 32
16PKS-5032	1 pc. / 15 pc.	50 x 32
16PKS-5040	1 pc. / 15 pc.	50 x 40
16PKS-6340	1 pc. / 8 pc.	63 x 40
16PKS-6350	1 pc. / 8 pc.	63 x 50

- 1
- 2
- 3
- 4
- 5
- 6
- 7
- 8
- 9
- 10
- 11
- 12



## D. PKS

### Type: 17PKS (CW617)



**Straight male adapter**  
**Recht aansluitstuk buitendraad**  
**Raccord droit mâle**  
**Übergangsfitting AG**

Article number	Bag / Box	Type
17PKS-3206	10 pc. / 40 pc.	32 x 1"
17PKS-3207	5 pc. / 25 pc.	32 x 1,1/4"
17PKS-4006	5 pc. / 25 pc.	40 x 1"
17PKS-4007	5 pc. / 25 pc.	40 x 1,1/4"
17PKS-5008	1 pc. / 10 pc.	50 x 1,1/2"
17PKS-6310	1 pc. / 6 pc.	63 x 2"

### Type: 17PKS-N (CW602)



**Straight male adapter**  
**Recht aansluitstuk buitendraad**  
**Raccord droit mâle**  
**Übergangsfitting AG**

Article number	Bag / Box	Type
17PKS-3206-N	10 pc. / 40 pc.	32 x 1"
17PKS-3207-N	5 pc. / 25 pc.	32 x 1,1/4"
17PKS-4006-N	5 pc. / 25 pc.	40 x 1"
17PKS-4007-N	5 pc. / 25 pc.	40 x 1,1/4"
17PKS-5008-N	1 pc. / 10 pc.	50 x 1,1/2"
17PKS-6310-N	1 pc. / 6 pc.	63 x 2"

### Type: 18PKS (CW617)



**Straight female adapter**  
**Recht aansluitstuk binnendraad**  
**Raccord droit femelle**  
**Übergangsfitting IG**

Article number	Bag / Box	Type
18PKS-3204	10 pc. / 40 pc.	32 x 1/2"
18PKS-3206	10 pc. / 40 pc.	32 x 1"
18PKS-3207	5 pc. / 25 pc.	32 x 1,1/4"
18PKS-4006	5 pc. / 25 pc.	40 x 1"
18PKS-4007	5 pc. / 25 pc.	40 x 1,1/4"
18PKS-5008	1 pc. / 10 pc.	50 x 1,1/2"
18PKS-6310	1 pc. / 6 pc.	63 x 2"

### Type: 18PKS-N (CW602)



**Straight coupling**  
**Recht aansluitstuk binnendraad**  
**Raccord droit femelle**  
**Übergangsfitting IG**

Article number	Bag / Box	Type
18PKS-3204-N	10 pc. / 40 pc.	32 x 1/2"
18PKS-3206-N	10 pc. / 40 pc.	32 x 1"
18PKS-3207-N	5 pc. / 25 pc.	32 x 1,1/4"
18PKS-4006-N	5 pc. / 25 pc.	40 x 1"
18PKS-4007-N	5 pc. / 25 pc.	40 x 1,1/4"
18PKS-5008-N	1 pc. / 10 pc.	50 x 1,1/2"
18PKS-6310-N	1 pc. / 6 pc.	63 x 2"



**Type: 27PKS**



45° bend  
Bocht 45°  
Coude 45°  
Winkel 45°

Article number	Bag / Box	Type
27PKS-3232	5 pc. / 30 pc.	32 x 32
27PKS-4040	2 pc. / 25 pc.	40 x 40
27PKS-5050	1 pc. / 10 pc.	50 x 50
27PKS-6363	1 pc. / 5 pc.	63 x 63

**Type: 50P**



Stainless steel sprinkler connection with stainless steel cup  
RVS instort sprinkler-aansluiting met RVS cup  
Raccord sprinkler en acier inoxydable avec coupelle en acier inoxydable  
Sprinkler-Anschluss aus Edelstahl mit Edelstahltasse

Article number	Bag / Box	Type
50P-3206	1 pc. / 15 pc.	32 x 1" (23 mm)
50P-320604	1 pc. / 15 pc.	32 x 1/2" (23 mm)
50P-320605	1 pc. / 15 pc.	32 x 3/4" (23 mm)
50P43-320604	1 pc. / 15 pc.	32 x 1/2" (43 mm)

**Type: 52PS**



Easy mounting/repair  
Eenvoudige montage/reparatie  
Montage / réparation facile  
Einfache Montage/Reparatur

Article number	Bag / Box	Type
52PS32	1 pc. / 20 pc.	32x32

**Type: 53PS**



Easy mounting/repair  
Eenvoudige montage/reparatie  
Montage / réparation facile  
Einfache Montage/Reparatur

Article number	Bag / Box	Type
53PKS40	1 pc. / 20 pc.	40x40
53PKS50	1 pc. / 9 pc.	50x50
53PKS63	1 pc. / 6 pc.	63x63

- 1
- 2
- 3
- 4
- 5
- 6
- 7
- 8
- 9
- 10
- 11
- 12





## E. SUPER SIZES - Systematic solution for big sizes

A = 75mm | B = 90mm

1 Detailed overview of Super Sizes possibilities

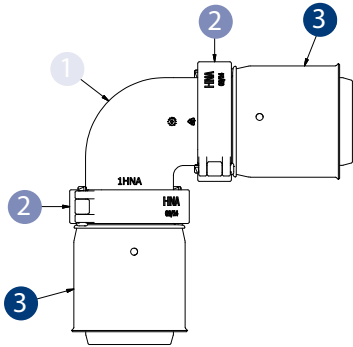

### 1PK

- 1 1HNA or 1HNB
- 2 HNA or HNB
- 3 8HNA-PK40 or 8HNA-PK50 or 8HNA-PK63 or 8HNA-PK75 or 8HNB-PK90

### Example / Voorbeeld / Exemple / Beispiel

1PK-7575 = 1x 1HNA + 2xHNA + 2x 8HNA-PK75

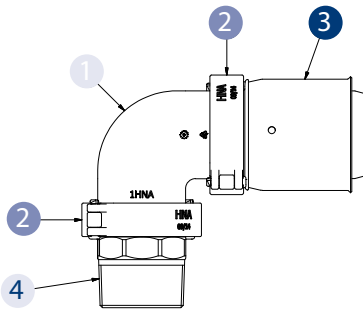

### 5PK / 6PK

- 1 1HNA or 1HNB
- 2 HNA or HNB
- 3 8HNA-PK75 or 8HNB-PK90
- 4 17HNA-10 or 17HNA-12 or 18HNA-06 or 18HNA-10 or 18HNA-12 or 18HNB-14

### Example / Voorbeeld / Exemple / Beispiel

5PK-7510 = 1x 1HNA + 2xHNA + 1x 8HNA-PK75 + 1x17HNA-10

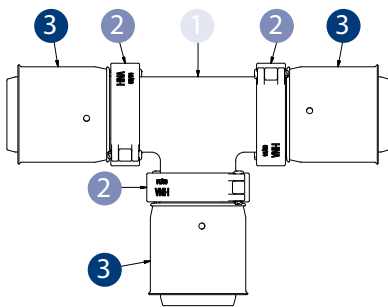

### 9PK / 10PK / 11PK / 12PK (75mm)

- 1 9HNA
- 2 HNA
- 3 8HNA-PK32 or 8HNA-PK40 or 8HNA-PK50 or 8HNA-PK63 or 8HNA-PK75

### Example / Voorbeeld / Exemple / Beispiel

9PK-757575 = 1x 9HNA + 3xHNA + 3x 8HNA-PK75

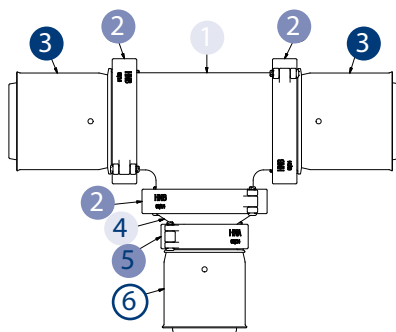

### 10PK / 11PK / 12PK (90mm)

- 1 9HNB
- 2 HNB
- 3 8HNB-PK90
- 4 16HNB
- 5 HNA
- 6 8HNA-PK32 or 8HNA-PK40 or 8HNA-PK50 or 8HNA-PK63 or 8HNA-PK75

### Example / Voorbeeld / Exemple / Beispiel

10PK-905090 = 1x 9HNB + 3x HNB + 2x 8HNB-PK90 + 1x 16HNB + 1xHNA + 8HNA-PK50

## E. SUPER SIZES - Systematic solution for big sizes

A = 75mm | B = 90 mm

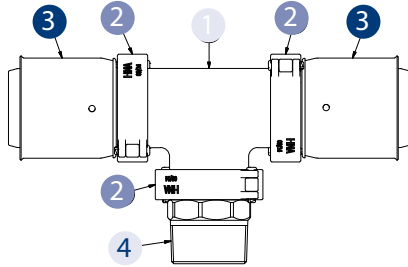

### 13PK / 14PK

- 1 9HNA or 9HNB
- 2 HNA or HNB
- 3 8HNA-PK75 or 8HNB-PK90
- 4 17HNA-10 or 17HNA-12 or 18HNA-06 or 18HNA-10 or 18HNA-12 or 18HNB-14

#### Example / Voorbeeld / Exemple / Beispiel

13PK-750675 = 1x 9HNA + 3x HNA + 8HNA-PK75 + 18HNA-06

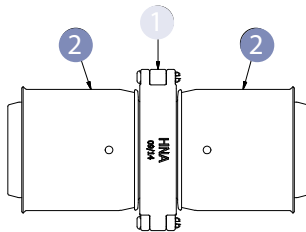

### 15PK / 16PK

- 1 HNA or HNB
- 2 8HNA-PK75 or 8HNB-PK90

#### Example / Voorbeeld / Exemple / Beispiel

15PK-7575 = 1x HNA + 2x 8HNA-PK75

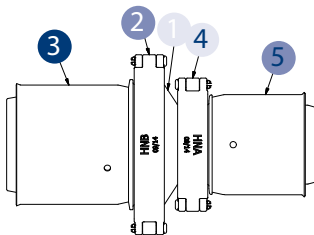

### 16PK

- 1 16HNBA
- 2 HNB
- 3 8HNB-PK90
- 4 HNA
- 5 8HNA-PK32 or 8HNA-PK40 or 8HNA-PK50 or 8HNA-PK63 or 8HNA-PK75

#### Example / Voorbeeld / Exemple / Beispiel

16PK-9063 = 1x 16HNBA + 1x HNB + 1x 8HNB-PK90 + 1x HNA + 1x 8HNA-PK63

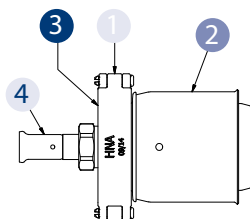

### 16PK-7516

- 1 HNA
- 2 8HNA-PK75
- 3 HNA-05
- 4 19P-1605 or 19P-1805 or 19P-2005 or 33P-1605 or 19SK-1605 or 19SK-2005

1

2

3

4

5

6

7

8

9

10

11

12



## E. SUPER SIZES - Systematic solution for big sizes

A = 75mm | B = 90 mm

1

2

3

4

5

6

7

8

9

10

11

12

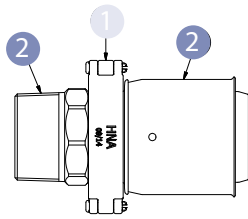

### 17PK / 18PK

- 1 HNA or HNB
- 2 8HNA-PK75 or 8HNB-PK90

### Example / Voorbeeld / Exemple / Beispiel

18PK-7512 = 1x HNA + 1x 8HNA-PK75 + 1x 18HNA-12

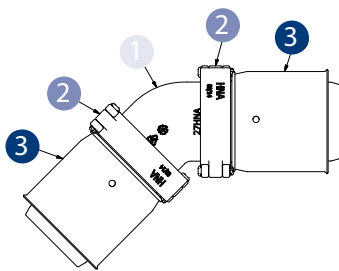

### 27PK

- 1 27HNA or 27HNB
- 2 HNA or HNB
- 3 8HNA-PK75 or 8HNB-PK90

### Example / Voorbeeld / Exemple / Beispiel

27PK-9090 = 1x 27HNB + 2xHNB + 2x 8HNB-PK90

### SUPER SIZE MONTAGE

\*HN connection = "click and lock"  
\*PK connection = press connection

### Possibilities

HNA: PK32 / PK40 / PK50 / PK63 / PK75  
HNB: PK90

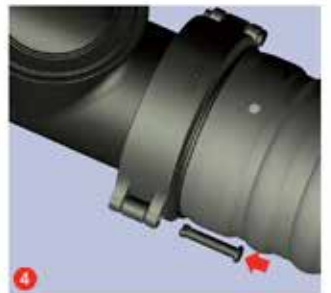
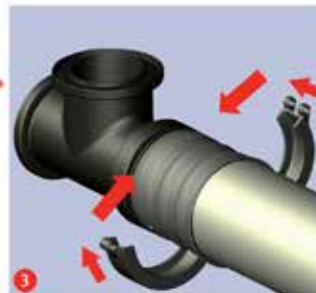
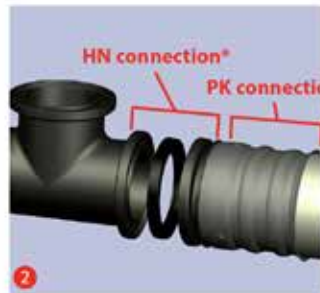



A = 75mm | B = 90 mm

## Type: 1HN



Elbow 90°  
Knie 90°  
Coude 90°  
Winkel 90°

Article number	Bag / Box	Type
1HNA	1 pc. / 10 pc.	HNAXHNA
1HNB	1 pc. / 1 pc.	HNBxHNB

## Type: 9HN



T-piece  
T-stuk  
Pièce en T  
T-Stuck

Article number	Bag / Box	Type
9HNA	1 pc. / 7 pc.	HNAXHNAXHNA
9HNB	1 pc. / 1 pc.	HNBxHNBxHNB

## Type: 16HN



Reducing coupling  
Verloopstuk  
Réduction  
Kupplung-reduziert

Article number	Bag / Box	Type
16HNBA	1 pc. / 15 pc.	HNBxHNA

## Type: 27HN



Elbow 45°  
Bocht 45°  
Coude 45°  
Winkel 45°

Article number	Bag / Box	Type
27HNA	1 pc. / 15 pc.	HNAXHNA
27HNB	1 pc. / 1 pc.	HNBxHNB

## Type: 8HN



Pressfitting  
Persfitting  
Raccord à sertir  
Pressfitting

Article number	Bag / Box	Type
8HNA-PK32	1 pc. / 20 pc.	HNAX32
8HNA-PK40	1 pc. / 20 pc.	HNAX40
8HNA-PK50	1 pc. / 15 pc.	HNAX50
8HNA-PK63	1 pc. / 12 pc.	HNAX63
8HNA-PK75	1 pc. / 12 pc.	HNAX75
8HNB-PK90	1 pc. / 4 pc.	HNBx90



## E. SUPER SIZES

A = 75mm | B = 90 mm

### 1 Type: HN



Bracket set  
Beugel set  
Support  
Bügel Set

Article number	Bag / Box	Type
HNA	1 pc. / 1 pc.	
HNB	1 pc. / 1 pc.	

### 2 Type: HN-PEN



Locking pin  
Beugelpin  
Goupille de verrouillage  
Sicherungsstift

Article number	Bag / Box	Type
HN-PEN	50 pc. / 50 pc.	HNA / HNB

### 3 Type: HN-U



Sealing ring  
Dichtingsring  
Anneau d'étanchéité  
Dichtungsring

Article number	Bag / Box	Type
HNA-U	10 pc. / 10 pc.	HNA
HNB-U	10 pc. / 10 pc.	HNB

### 4 Type: 17HN (CW617)



Brass adapter male  
Messing adapter buitendraad  
Raccord en laiton mâle  
Anschluss Bügel AG

Article number	Bag / Box	Type
17HNA-10	1 pc. / 22 pc.	HNAx2"
17HNA-12	1 pc. / 18 pc.	HNAx2 1/2"

### 5 Type: 17HN-N (CW602)



Brass adapter male  
Messing adapter buitendraad  
Raccord en laiton mâle  
Anschluss Bügel AG

Article number	Bag / Box	Type
17HNA-10-N	1 pc. / 22 pc.	HNAx2"
17HNA-12-N	1 pc. / 18 pc.	HNAx2 1/2"

### 6 Type: 18HN (CW617)



Brass adapter female  
Messing adapter binnendraad  
Raccord en laiton femelle  
Anschluss Bügel IG

Article number	Bag / Box	Type
18HNA-06	1 pc. / 40 pc.	HNAx1"
18HNA-10	1 pc. / 27 pc.	HNAx2"
18HNA-12	1 pc. / 16 pc.	HNAx2 1/2"
18HNB-14	1 pc. / 12 pc.	HNBx3"





A = 75mm | B = 90 mm

## Type: 18HN-N (CW602)



Brass adapter female  
Messing adapter binnendraad  
Raccord en laiton femelle  
Anschluss Bügel IG

Article number	Bag / Box	Type
18HNA-06-N	1 pc. / 40 pc.	HNAx1"
18HNA-10-N	1 pc. / 27 pc.	HNAx2"
18HNA-12-N	1 pc. / 16 pc.	HNAx2 1/2"
18HNB-14-N	1 pc. / 12 pc.	HNBx3"

## Type: HN-STOP



Stop end for Super Size range  
Eindstop voor Super Size gamma  
Bouchon d'arrêt Super Size  
Endkappe für das Sortiment Super Size

Article number	Bag / Box	Type
HNA-STOP	1 pc. / 90 pc.	HNA
HNB-STOP	1 pc. / 40 pc.	HNB

## Type: HN-STOP-E



Stop end for Super Size range  
Eindstop voor Super Size gamma  
Bouchon d'arrêt Super Size  
Endkappe für das Sortiment Super Size

Article number	Bag / Box	Type
HNA-STOP-E	1 pc. / 90 pc.	HNA

## Type: HNA-EK05 (CW625N)



Adapter HNA x EK 3/4"  
Overgang HNA x EK 3/4"  
Réduction HNA x EK 3/4"  
Übergang HNA x EK 3/4"

Article number	Bag / Box	Type
HNA-EK05	1 pc. / 50 pc.	HNA x 3/4" EK

## Type: HNA-COMP



Expansion bellow  
HNA Compensator  
Compensateur HNA  
Kompensator

Article number	Packing	Type
HNA-COMP	1 pc.	HNA

## Type: HNAFL



Flange connection  
Flensaansluiting  
Raccordement bride  
Flanschverbindung

Article number	Packing	Type
HNAFL-DN50	1 pc.	75xDN50

1

2

3

4

5

6

7

8

9

10

11

12



## F. HENCO ECOLINE

### Type: HNA-ECOLINE-SET



Basic set for Inliner  
 Basisset voor Inliner  
 Set de base pour Inliner  
 Grundsatz für Inliner

Article number	Bag / Box	Type
HNA-ECOLINE-SET	1 pc. / -	

Compostion:  
 1x 9HNA (T-piece)  
 4x HNA (Bracket set)  
 1x HNA-EK05 (Adapter HNA-EK)  
 1x HNA-INLB (Base plate for inliner)

The Henco ECO-line is an energy saving solution for recirculation loops, which limits heat loss between supply and return pipe.

A separate pipe for the circulation water is no longer required.

Designed on the Henco Super Size concept, it also combines modularity and easy installation.

#### ONE CONCEPT FOR ALL DIMENSIONS FROM 40 UP TO 75MM

- Cost effective
- Easy installation
- Less space consumption
- Anti legionellosis

#### Necessary items to complete the ECOLINE installation \*

Article number	Description	Page
8HNA-PK...	Press fitting 40, 50, 63 or 75	54
50-MXC1620	Henco 1L PE-Xc 16x2 - 100m	-
19P-1605	Nickel plated press-fit adapter to eurocone 16x3/4"	77
19P-2005	Nickel plated press-fit adapter to eurocone 20x3/4"	77
33P-1605	Nickel plated press-fit adapter to eurocone 90°	81
19PK-1605	Press fit swivel to eurocone 16x3/4"	30
19PK-2005	Press fit swivel to eurocone 20x3/4"	30
19SK-1605	Push fitting with eurocone connection 16x3/4"	63
19SK-2005	Push fitting with eurocone connection 20x3/4"	63



\* To complete the Ecoline installation you need to have a circulator and thermostatic balancing valve (not in Henco range)



	<i>Page</i>
<b>A. SK</b>	<b>64</b>
<b>B. MANIFOLDS</b>	<b>70</b>



## A. SK

### Type: 1SK



Elbow 90°  
Knie 90°  
Coude 90°  
Winkel 90°

Article number	Bag / Box	Type
1SK-1616	10 pc. / 70 pc.	16x16
1SK-2020	10 pc. / 50 pc.	20x20
1SK-2626	5 pc. / 40 pc.	26x26

### Type: 2SK



Backplate elbow female  
Sanitair muurplaat binnendraad  
Culasse pour sanitaire femelle  
Sanitär Wandscheibe IG

Article number	Bag / Box	Type
2SK-1604BP*	10 pc. / 40 pc.	16x1/2" (56 mm)
2SK-2004BP*	10 pc. / 40 pc.	20X1/2" (56 mm)
2SK-2005	10 pc. / 30 pc.	20X3/4" (56 mm)
2SK-2605	5 pc. / 20 pc.	26X3/4" (56 mm)

\* With black plug BP04 1/2"

### Type: 2S



Backplate elbow female, short model  
Sanitair muurplaat binnendraad kort  
Culasse pour sanitaire femelle, modèle court  
Sanitär Wandscheibe IG, kurzes Model

Article number	Bag / Box	Type
2S-1604K	10 pc. / 50 pc.	16x1/2" (43 mm)

Accessory 2PK & 2PK-K: galvanised bracket plate - see page 154



PLP-P-PK



PLF-P-PK

### Type: 3SK



Double backplate elbow female, short model  
Dubbel sanitair muurplaat binnendraad, laag  
Culasse double pour sanitaire, modèle court  
Sanitär Wandscheibe doppelt IG, kurzes Modell

Article number	Bag / Box	Type
3SK-160416BP *	10 pc. / 30 pc.	16X1/2" (40 mm)
3SK-200420BP *	10 pc. / 30 pc.	20X1/2" (40 mm)

\* With black plug BP04 1/2"



**Type: 5SK**



PK-TOOL p 157

**Bend 90° male adapter**  
**Knie 90° buitendraad**  
**Coude 90° mâle**  
**Winkel 90° AG**

Article number	Bag / Box	Type
5SK-1604	10 pc. / 60 pc.	16X1/2"
5SK-2004	10 pc. / 50 pc.	20X1/2"
5SK-2005	10 pc. / 40 pc.	20X3/4"
5SK-2605	5 pc. / 30 pc.	26X3/4"

**Type: 6SK**



PK-TOOL p 157

**Bend 90° female adapter**  
**Knie 90° binnendraad**  
**Coude 90° femelle**  
**Winkel 90° IG**

Article number	Bag / Box	Type
6SK-1604BP *	10 pc. / 60 pc.	16X1/2"
6SK-2004BP *	10 pc. / 60 pc.	20X1/2"
6SK-2005	10 pc. / 30 pc.	20X3/4"
6SK-2605	10 pc. / 30 pc.	26X3/4"

\* With black plug BP04 1/2"

**Type: 9SK**



**T-piece**  
**T-stuk**  
**Pièce en T**  
**T-Stuck**

Article number	Bag / Box	Type
9SK-161616	10 pc. / 40 pc.	16x16x16
9SK-202020	10 pc. / 30 pc.	20x20x20
9SK-262626	5 pc. / 20 pc.	26x26x26

**Type: 10SK**



**T-reduced centre**  
**T-verlopend**  
**Pièce en T réduit**  
**T-reduziert**

Article number	Bag / Box	Type
10SK-201620	10 pc. / 40 pc.	20x16x20
10SK-261626	5 pc. / 25 pc.	26x16x26
10SK-262026	5 pc. / 20 pc.	26x20x26





## A. SK

### 1 Type: 11SK



T-branch and line reduced

T-2X verlopend

Pièce en T 2X réduit

T-2X reduziert

Article number	Bag / Box	Type
11SK-201616	10 pc. / 40 pc.	20x16x16
11SK-202016	10 pc. / 30 pc.	20x20x16
11SK-261620	5 pc. / 25 pc.	26x16x20
11SK-262016	5 pc. / 25 pc.	26x20x16
11SK-262020	5 pc. / 25 pc.	26x20x20
11SK-262616	5 pc. / 25 pc.	26x26x16
11SK-262620	5 pc. / 20 pc.	26x26x20

### 2 Type: 12SK



T-enlarged branch

T-vergroot

Pièce en T agrandi

T-erweitert

Article number	Bag / Box	Type
12SK-162016	10 pc. / 40 pc.	16x20x16
12SK-202620	5 pc. / 30 pc.	20x26x20

### 3 Type: 13SK



PK-TOOL p 157

T-female centre

T-binnendraad

Pièce en T femelle

T-IG

Article number	Bag / Box	Type
13SK-160416BP *	10 pc. / 40 pc.	16x1/2"x16
13SK-200420BP *	10 pc. / 30 pc.	20x1/2"x20
13SK-200520	10 pc. / 30 pc.	20x3/4"x20
13SK-260420BP *	5 pc. / 20 pc.	26x1/2"x20
13SK-260426BP *	5 pc. / 20 pc.	26x1/2"x26
13SK-260526	5 pc. / 20 pc.	26x3/4"x26

\* With black plug BP04 1/2"

### 4 Type: 14SK



PK-TOOL p 157

T-male centre

T-buitendraad

Pièce en T mâle

T-AG

Article number	Bag / Box	Type
14SK-160416	10 pc. / 40 pc.	16x1/2"x16
14SK-200420	10 pc. / 30 pc.	20x1/2"x20
14SK-260426	5 pc. / 20 pc.	26x1/2"x26



**Type: 15SK**



**Straight coupling**  
**Doorverbinder recht**  
**Manchon**  
**Kupplung**

Article number	Bag / Box	Type
15SK-1616	10 pc. / 70 pc.	16x16
15SK-2020	10 pc. / 60 pc.	20x20
15SK-2626	5 pc. / 30 pc.	26x26

**Type: 16SK**



**Reducing coupling**  
**Verloopstuk**  
**Réduction**  
**Kupplung-reduziert**

Article number	Bag / Box	Type
16SK-2016	10 pc. / 80 pc.	20x16
16SK-2616	10 pc. / 50 pc.	26x16
16SK-2620	10 pc. / 40 pc.	26x20

**Type: 17SK**



**Straight male adapter**  
**Recht aansluitstuk buitendraad / Puntstuk**  
**Raccord droit mâle**  
**Übergangsfitting AG**

Article number	Bag / Box	Type
17SK-1603	10 pc. / 80 pc.	16x3/8"
17SK-1604	10 pc. / 80 pc.	16x1/2"
17SK-2004	10 pc. / 60 pc.	20x1/2"
17SK-2005	10 pc. / 60 pc.	20x3/4"
17SK-2605	10 pc. / 40 pc.	26x3/4"
17SK-2606	10 pc. / 40 pc.	26x1"



PK-TOOL p 157

**Type: 18SK**



**Straight female adapter**  
**Recht aansluitstuk binnendraad / Schroefbus**  
**Raccord droit femelle**  
**Übergangsfitting IG**

Article number	Bag / Box	Type
18SK-1604	10 pc. / 80 pc.	16x1/2"
18SK-2004	10 pc. / 80 pc.	20x1/2"
18SK-2005	10 pc. / 60 pc.	20x3/4"
18SK-2605	10 pc. / 50 pc.	26x3/4"
18SK-2606	10 pc. / 40 pc.	26x1"



PK-TOOL p 157

- 1
- 2
- 3
- 4
- 5
- 6
- 7
- 8
- 9
- 10
- 11
- 12



## A. SK

### 1 Type: 17SKS

2

3

4

5

6

7



Straight nipple male (brass)  
 Recht aansluitstuk buitendraad (messing)  
 Raccord droit mâle (laiton)  
 Übergangsfitting AG (Messing)

Article number	Bag / Box	Type
17SKS-2004	5 pc. / 150 pc.	20x1/2"
17SKS-2005	5 pc. / 150 pc.	20x3/4"
17SKS-2604	5 pc. / 100 pc.	26x1/2"
17SKS-2605	5 pc. / 100 pc.	26x3/4"

*Applicable with HENCO Vision fittings & Full Flow Manifold*

### 8 Type: 18SKS

9

10

11

12



Straight nipple female (brass)  
 Recht aansluitstuk binnendraad (messing)  
 Raccord droit femelle (laiton)  
 Übergangsfitting IG (Messing)

Article number	Bag / Box	Type
18SKS-2004	5 pc. / 150 pc.	20x1/2"
18SKS-2005	5 pc. / 100 pc.	20x3/4"
18SKS-2604	5 pc. / 100 pc.	26x1/2"
18SKS-2605	5 pc. / 80 pc.	26x3/4"

*Applicable with HENCO Vision fittings & Full Flow Manifold*

### Type: 19SK



Push fitting with eurocone connection  
 Steekkoppeling met euroconus-aansluiting  
 Raccord push fit avec eurocone  
 Steckkupplung mit Eurokonus

Article number	Bag / Box	Type
19SK-1505	10 pc. / 80 pc.	15x3/4"
19SK-1605	10 pc. / 80 pc.	16x3/4"
19SK-2005	10 pc. / 80 pc.	20x3/4"

### Type: 26SK



Push fitting with swivel and flat sealing  
 Steekkoppeling met wartel en vlakke dichting  
 Raccord push fit avec raccord ecrou etanchéité plate  
 Steckkupplung mit Drehbar und flach Versiegelung

Article number	Bag / Box	Type
26SK-1605	10 pc. / 80 pc.	16x3/4"
26SK-2005	10 pc. / 80 pc.	20x3/4"



### Type: SK-PIPESTOP



Stop end for pipe  
Eindstop voor buis  
Bouchon pour tube  
Endkappe für Rohre

Article number	Bag / Box	Type
SK-PIPESTOP16	10 pc. / 120 pc.	16
SK-PIPESTOP20	10 pc. / 80 pc.	20
SK-PIPESTOP26	10 pc. / 80 pc.	26

### Type: SK-STOPCLIP



Reusable stop and clip for push fit connection  
Herbruikbare stop en clip passend in een steekkoppeling  
Bouchon et clip réutilisables pour connection push fit  
Stopfen und clip für Steckanschluss, wieder verwendbar

Article number	Bag / Box	Type
SK-STOPCLIP16	10 pc. / 120 pc.	16
SK-STOPCLIP20	10 pc. / 100 pc.	20
SK-STOPCLIP26	10 pc. / 80 pc.	26

### Type: VISION SET



Vision revision set  
Vision revisie set  
Set de révision Vision  
Vision set

Article number	Bag / Box	Type
VISION SET 16	1 pc. / 100 pc.	16
VISION SET 20	1 pc. / 90 pc.	20
VISION SET 26	1 pc. / 80 pc.	26

### Type: VISION KEY



Vision disassembly key  
Vision demontage sleutel  
Clé de démontage Vision  
Vision Entriegelungsschlüssel

Article number	Bag / Box	Type
VISION-KEY16	1 pc. / 200 pc.	16
VISION-KEY20	1 pc. / 200 pc.	20
VISION-KEY26	1 pc. / 200 pc.	26



## B. MANIFOLDS

### Type: VSK-1616



Extension or body for manifold, two SK connections Ø16  
 Verlengstuk of basis voor verdeler, twee SK-aansluitingen Ø16  
 Complément ou base collecteur, deux sorties SK Ø16  
 Erweiterung oder Basiskörper für Verteiler, zwei SK-Anschlüssen Ø16

Article number	Bag / Box	Type
VSK-1616	1 pc. / 14 pc.	1616

### Type: VSK-161616



Extension or body for manifold, three SK connections Ø16  
 Verlengstuk of basis voor verdeler, drie SK-aansluitingen Ø16  
 Complément ou base collecteur, trois sorties SK Ø16  
 Erweiterung oder Basiskörper für Verteiler, drei SK-Anschlüssen Ø16

Article number	Bag / Box	Type
VSK-161616	1 pc. / 14 pc.	161616

### Type: SK-B05



Bracket for manifolds and VBS manifolds  
 Montagebeugel voor verdelers en VBS verdelers  
 Double support pour collecteurs et VBS  
 Halter für Verteiler und VBS Verteiler

Article number	Bag / Box	Typ
SK-B05	1 pc. / 200 pc.	B05

### Type: VB-EK05



Ball valve, 2 x eurocone connection  
 Bolkraan, 2 x euroconus aansluiting  
 Vanne d'arrêt, 2 x raccordement eurocone  
 Kugelhahn, 2 x Eurokonus

Article number	Box / Big Box	Type
VB-EK05	25 pc. / 200 pc.	3/4" EK x 3/4" EK

*See chapter 6A for more options for the Full Flow Manifold*



**BRASS PRESS FITTINGS - MESSING PERSFITTINGEN  
RACCORDS À SERTIR EN LAITON - PRESSFITTINGS AUS MESSING**



	<i>Page</i>
<b>A. P</b>	<b>72</b>
<b>B. PG</b>	<b>84</b>



## A. P

### Type: 1P



Elbow 90°  
Knie 90°  
Coude 90°  
Winkel 90°

Article number	Bag / Box	Type
1P-1616	10 pc. / 150 pc.	16x16
1P-1818	10 pc. / 100 pc.	18x18
1P-2020	10 pc. / 80 pc.	20x20
1P-2626	5 pc. / 50 pc.	26x26
1P-3232	5 pc. / 50 pc.	32x32

### Type: 2P



Backplate elbow female  
Sanitair muurplaat binnendraad  
Culasse pour sanitaire femelle  
Sanitär Wandscheibe IG

Article number	Bag / Box	Type
2P-1604	10 pc. / 50 pc.	16x1/2" (52 mm)
2P-1804	10 pc. / 50 pc.	18x1/2" (52 mm)
2P-2004	10 pc. / 50 pc.	20x1/2" (52 mm)
2P-2005	10 pc. / 50 pc.	20x3/4" (52 mm)
2P-2605	5 pc. / 50 pc.	26x3/4" (52 mm)

### Type: 2P-K



Backplate elbow female, short model  
Sanitair muurplaat binnendraad, laag  
Culasse pour sanitaire femelle, modèle court  
Sanitär Wandscheibe IG, kurzes Modell

Article number	Bag / Box	Type
2P-1404K	10 pc. / 50 pc.	14x1/2" (35 mm)
2P-1604K	10 pc. / 50 pc.	16x1/2" (35 mm)

### Type: 3P



Double backplate elbow female  
Sanitaire muurplaat binnendraad, dubbel  
Culasse double pour sanitaire femelle  
Sanitär Wandscheibe doppelt IG

Article number	Bag / Box	Type
3P-160416	10 pc. / 40 pc.	16x1/2"x16 (52 mm)
3P-200420	10 pc. / 40 pc.	20x1/2"x20 (52 mm)

### Type: 3P-VK



Double backplate female (flow), short model  
Doorstroom muurplaat binnendraad, laag  
Culasse double femelle (écoulement), modèle court  
Wandscheibe doppelt IG (Fluss), kurzes Modell

Article number	Bag / Box	Type
3P-160416VK	5 pc. / 20 pc.	16x1/2"x16 (40 mm)
3P-200420VK	5 pc. / 20 pc.	20x1/2"x20 (40 mm)
3P-260426VK	5 pc. / 20 pc.	26x1/2"x26 (40mm)



Accessory for 2P, 2P-K, 3P-VK, 4P:  
galvanised bracket plate - see  
page 158



PLP-P-PK



PLF-P-PK

#### Type: 4P

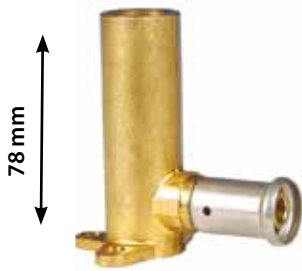

Backplate elbow female, extended model  
Sanitair muurplaat binnendraad, hoog  
Culasse pour sanitaire femelle, modèle long  
Sanitär Wandscheibe IG, langes Modell

Article number	Bag / Box	Type
4P-1604	10 pc. / 40 pc.	16x1/2" (78 mm)
4P-2004	10 pc. / 40 pc.	20x1/2" (78 mm)

#### Type: 5P



Bend 90° male adapter  
Knie 90° buitendraad  
Coude 90° mâle  
Winkel 90° AG

Article number	Bag / Box	Type
5P-1603	10 pc. / 150 pc.	16x3/8"
5P-1603DZR	10 pc. / 150 pc.	16x3/8"
5P-1604	10 pc. / 150 pc.	16x1/2"
5P-1604DZR	10 pc. / 150 pc.	16x1/2"
5P-1804	10 pc. / 120 pc.	18x1/2"
5P-2004	10 pc. / 100 pc.	20x1/2"
5P-2005	10 pc. / 80 pc.	20x3/4"
5P-2605	10 pc. / 60 pc.	26x3/4"
5P-3206	5 pc. / 25 pc.	32x1"

\* DZR = Brass alloy CW602N"

#### Type: 6P



Bend 90° female adapter  
Knie 90° binnendraad  
Coude 90° femelle  
Winkel 90° IG

Article number	Bag / Box	Type
6P-1604	10 pc. / 120 pc.	16x1/2"
6P-1804	10 pc. / 120 pc.	18x1/2"
6P-2004	10 pc. / 120 pc.	20x1/2"
6P-2005	10 pc. / 50 pc.	20x3/4"
6P-2605	5 pc. / 50 pc.	26x3/4"

#### Type: 7P



Backplate elbow male  
Sanitair muurplaat buitendraad met binnendraad 1/2"  
Culasse pour sanitaire mâle  
Sanitär Wandscheibe AG

Article number	Bag / Box	Type
7P-1605	10 pc. / 30 pc.	16x3/4" (78 mm)
7P-1605K	5 pc. / 30 pc.	16x3/4" (60 mm)
7P-1605L	5 pc. / 30 pc.	16x3/4" (70 mm)



## A. P

### 1 Type: 8P



Sanitary adapter female  
Sanitair aansluitstuk met binnendraad  
Culasse pour sanitaire femelle  
UP-Spülkastenwinkel

Article number	Bag / Box	Type
8P-1604	10 pc. / 50 pc.	16x1/2"

### 2 Type: 9P



T-piece  
T-stuk  
Pièce en T  
T-Stück

Article number	Bag / Box	Type
9P-161616	10 pc. / 60 pc.	16x16x16
9P-181818	10 pc. / 60 pc.	18x18x18
9P-202020	10 pc. / 50 pc.	20x20x20
9P-262626	5 pc. / 30 pc.	26x26x26
9P-323232	1 pc. / 20 pc.	32x32x32

### 3 Type: 10P



T-reduced centre  
T-verlopend  
Pièce en T réduit  
T-reduziert

Article number	Bag / Box	Type
10P-181618	10 pc. / 50 pc.	18x16x18
10P-201620	10 pc. / 50 pc.	20x16x20
10P-261626	5 pc. / 30 pc.	26x16x26
10P-262026	5 pc. / 30 pc.	26x20x26
10P-321632	5 pc. / 20 pc.	32x16x32
10P-322032	5 pc. / 20 pc.	32x20x32
10P-322632	5 pc. / 20 pc.	32x26x32

### 4 Type: 11P



T-branch and line reduced  
T-2x verlopend  
Pièce en T 2x réduit  
T-2x reduziert

Article number	Bag / Box	Type
11P-201616	10 pc. / 50 pc.	20x16x16
11P-202016	10 pc. / 50 pc.	20x20x16
11P-261620	5 pc. / 30 pc.	26x16x20
11P-262020	5 pc. / 30 pc.	26x20x20
11P-262616	5 pc. / 30 pc.	26x26x16
11P-262620	5 pc. / 30 pc.	26x26x20
11P-322026 *	5 pc. / 20 pc.	32x20x26
11P-322626 *	5 pc. / 20 pc.	32x26x26



**Type: 12P**

**T-enlarged branch**  
**T-vergroot**  
**Pièce en T agrandi**  
**T-erweitert**

Article number	Bag / Box	Type
12P-162016	10 pc. / 60 pc.	16x20x16
12P-202620	5 pc. / 30 pc.	20x26x20
12P-263226	5 pc. / 20 pc.	26x32x26

**Type: 13P**

**T-female centre branch**  
**T-binnendraad**  
**Pièce en T femelle**  
**T-IG**

Article number	Bag / Box	Type
13P-160416	10 pc. / 60 pc.	16x1/2"x16
13P-200420	10 pc. / 50 pc.	20x1/2"x20
13P-200520	10 pc. / 30 pc.	20x3/4"x20
13P-260426	5 pc. / 30 pc.	26x1/2"x26
13P-260526	5 pc. / 30 pc.	26x3/4"x26
13P-320532	5 pc. / 20 pc.	32x3/4"x32

**Type: 14P**

**T-male centre branch**  
**T-buitendraad**  
**Pièce en T mâle**  
**T-AG**

Article number	Bag / Box	Type
14P-160416	10 pc. / 60 pc.	16x1/2"x16
14P-200420	10 pc. / 60 pc.	20x1/2"x20
14P-200520	5 pc. / 30 pc.	20x3/4"x20
14P-260426	5 pc. / 30 pc.	26x1/2"x26

**Type: 15P**

**Straight coupling**  
**Doorverbinder recht / perssok**  
**Manchon**  
**Kupplung**

Article number	Bag / Box	Type
15P-1414	10 pc. / 200 pc.	14x14
15P-1616	10 pc. / 200 pc.	16x16
15P-1818	10 pc. / 150 pc.	18x18
15P-2020	10 pc. / 140 pc.	20x20
15P-2626	5 pc. / 80 pc.	26x26
15P-3232	5 pc. / 50 pc.	32x32





## A. P

### Type: 16P



Reducing coupling

Verloopstuk

Réduction

Kupplung-reduziert

Article number	Bag / Box	Type
16P-1614	10 pc. / 150 pc.	16x14
16P-1816	10 pc. / 150 pc.	18x16
16P-2016	10 pc. / 150 pc.	20x16
16P-2018	10 pc. / 150 pc.	20x18
16P-2616	5 pc. / 100 pc.	26x16
16P-2620	5 pc. / 80 pc.	26x20
16P-3216 *	5 pc. / 60 pc.	32x16
16P-3220 *	5 pc. / 60 pc.	32x20
16P-3226	5 pc. / 60 pc.	32x26

### Type: 17P



Straight male adapter

Recht aansluitstuk buitendraad / Puntstuk

Raccord droit mâle

Übergangsfitting AG

Article number	Bag / Box	Type
17P-1603	10 pc. / 150 pc.	16x3/8"
17P-1603DZR	10 pc. / 150 pc.	16x3/8"
17P-1604	10 pc. / 150 pc.	16x1/2"
17P-1604DZR	10 pc. / 150 pc.	16x1/2"
17P-1605	10 pc. / 150 pc.	16x3/4"
17P-1804	10 pc. / 150 pc.	18x1/2"
17P-1805	10 pc. / 150 pc.	18x3/4"
17P-2004	10 pc. / 150 pc.	20x1/2"
17P-2005	10 pc. / 150 pc.	20x3/4"
17P-2605	5 pc. / 80 pc.	26x3/4"
17P-2606	5 pc. / 80 pc.	26x1"
17P-3206	5 pc. / 50 pc.	32x1"
17P-3207 *	5 pc. / 40 pc.	32x1 1/4"

### Type: 18P



Straight female adapter

Recht aansluitstuk binnendraad / Schroefbus

Raccord droit femelle

Übergangsfitting IG

Article number	Bag / Box	Type
18P-1604	10 pc. / 150 pc.	16x1/2"
18P-1804	10 pc. / 120 pc.	18x1/2"
18P-2004	10 pc. / 100 pc.	20x1/2"
18P-2005	10 pc. / 100 pc.	20x3/4"
18P-2605	5 pc. / 80 pc.	26x3/4"
18P-2606	5 pc. / 70 pc.	26x1"
18P-3206	5 pc. / 50 pc.	32x1"
18P-3207 *	5 pc. / 30 pc.	32x1 1/4"

**Type: 19P**

Press-fit adapter to eurocone  
Aansluiting met wartel en euroconus-koppeling  
Raccordement avec raccord à visser eurocone  
Anschlussverschraubung mit Eurokonus

Article number	Bag / Box	Type
19P-1405	10 pc. / 150 pc.	14x3/4"
19P-1605	10 pc. / 150 pc.	16x3/4"
19P-1805	10 pc. / 150 pc.	18x3/4"
19P-2005	10 pc. / 140 pc.	20x3/4"

**Type: 24P**

Radiator connection nickel-plated 300 mm copper pipe Ø15  
Radiatoraansluitbocht vernikkeld met 300 mm koperbuis Ø15  
Alimentation radiateur nickelé 300 mm tube de cuivre Ø15  
Heizkörperanschluss vernickelt 300 mm Kupferrohr Ø15

Article number	Bag / Box	Type
24P-1604	2 pc. / 50 pc.	16x15Cu
24P-2004	2 pc. / 50 pc.	20x15Cu

**Type: 25P**

Radiator connection nickel-plated 1100 mm copper pipe Ø15  
Radiatoraansluitbocht vernikkeld met 1100 mm koperbuis Ø15  
Alimentation radiateur nickelé 1100 mm tube de cuivre Ø15  
Heizkörperanschluss vernickelt 1100 mm Kupferrohr Ø15

Article number	Tasche	Type
25P-1604	2 pc.	16x15Cu

**Type: 26P**

Union with flat seat  
3-delige koppeling vlak dichtend  
Raccord union à joint plat  
Verschraubung flachdichtend

Article number	Bag / Box	Type
26P-1604	10 pc. / 100 pc.	16x1/2"
26P-1605	10 pc. / 80 pc.	16x3/4"
26P-2004	10 pc. / 80 pc.	20x1/2"
26P-2005	10 pc. / 70 pc.	20x3/4"
26P-2605	5 pc. / 50 pc.	26x3/4"
26P-2606	5 pc. / 40 pc.	26x1"
26P-3206	5 pc. / 40 pc.	32x1"

**Type: 26P-Z**

Press fitting swivel adapter  
Aansluiting met wartel, vlakke dichting  
Raccord à visser, joint plat  
Pressfitting mit IG flachdichtend ohne Nippel

Article number	Bag / Box	Type
26P-16Z03	10 pc. / 150 pc.	16x3/8"
26P-16Z04	10 pc. / 150 pc.	16x1/2"
26P-16Z05	10 pc. / 80 pc.	16x3/4"
26P-20Z04	10 pc. / 150 pc.	20x1/2"
26P-20Z05	10 pc. / 70 pc.	20x3/4"
26P-26Z05	5 pc. / 50 pc.	26x3/4"
26P-26Z06	5 pc. / 40 pc.	26x1"
26P-32Z06	5 pc. / 40 pc.	32x1"
26P-32Z07	5 pc. / 40 pc.	32x1 1/4"



## A. P

### Type: N



**Nipple for 26P-Z**  
**Nippel voor 26P-Z**  
**Nipple pour 26P-Z**  
**Nippel für 26P-Z**

Article number	Bag / Box	Type
N04	10 pc. / 250 pc.	1/2"x3/4"
N05	10 pc. / 200 pc.	3/4"x3/4"
N06	25 pc. / 250 pc	1"x1"

### Type: 27P



**45° bend**  
**Bocht 45°**  
**Coude 45°**  
**Winkel 45°**

Article number	Bag / Box	Type
27P-2626	5 pc. / 50 pc.	26x26
27P-3232	5 pc. / 30 pc.	32x32

### Type: 28P



**Double backplate elbow female, build-up**  
**Dubbele muurplaat binnendraad, opbouw**  
**Culasse double pour sanitaire femelle**  
**Sanitär Wandscheibe doppelt IG, Oberbau**

Article number	Bag / Box	Type
28P-14041604-1	1 pc. / 20 pc.	14x1/2"x16x1/2" (153 mm)
28P-16041604-1	1 pc. / 20 pc.	16x1/2"x16x1/2" (153 mm)

### Type: 28PV



**Double backplate elbow female, build-in**  
**Dubbele muurplaat binnendraad, inbouw**  
**Culasse double surélevé**  
**Wandwinkel doppelt erhöht**

Article number	Bag / Box	Type
28PV-16031603-1	1 pc. / 15 pc.	16x3/8"x16x3/8" (120 mm)
28PV-16041604-1	1 pc. / 15 pc.	16x1/2"x16x1/2" (153 mm)

### Type: 28PF



**Double backplate elbow female for plaster**  
**Dubbel muurplaat binnendraad voor gips**  
**Culasse double femelle pour plâtre**  
**Wandscheibe doppelt IG für Gips**

Article number	Bag / Box	Type
28PF-16041604	1 pc. / 1 pc.	16x1/2"x16x1/2"
28PF-20042004	1 pc. / 1 pc.	20x1/2"x20x1/2"



### Type: 29P-CS (CW724)



Press-fit adapter with copper pipe  
 Persfitting verlengd met koperbuis  
 Manchon à sertir avec tube en cuivre  
 Pressfitting mit Kupferrohr

Article number	Bag / Box	Type
29P-1612-CS	10 pc. / 120 pc.	16x12 (50mm copper)
29P-1615-CS	10 pc. / 120 pc.	16x15 (50mm copper)
29P-2018-CS	10 pc. / 70 pc.	20x18 (50mm copper)
29P-2022-CS	10 pc. / 70 pc.	20x22 (50mm copper)
29P-2622-CS	10 pc. / 70 pc.	26x22 (50mm copper)

### Type: 30P



Press-fit adapter to copper compression  
 Overgangsstuk Henco pers x koperbuis knelkoppeling  
 Manchon à sertir x tube en cuivre manchon à visser  
 Pressfitting x Klemmverbinder für Kupferrohr

Article number	Bag / Box	Type
30P-1614S	10 pc. / 120 pc.	16x14 Cu
30P-1615S-2	2 pc. / 100 pc.	16x15 Cu
30P-2022S	10 pc. / 100 pc.	20x22 Cu
30P-2622S	10 pc. / 80 pc.	26x22 Cu

### Type: 31P



Double crossover tee, nickel plated  
 Kruisingsvrij T-stuk, vernikkeld  
 Double T croisé, étamé  
 Kreuzungs-T-Stück, vernickelt

Article number	Bag / Box	Type
31P-161616	1 pc. / 20 pc.	16x16x16
31P-201616	1 pc. / 20 pc.	20x16x16
31P-201620	1 pc. / 20 pc.	20x16x20
31P-202020	1 pc. / 20 pc.	20x20x20

### Type: ISO-BOX



Insulation box for double crossover tee  
 Isolatiebox voor kruisingsvrij T-Stuk  
 Boîte d'isolation pour T croisé  
 Isolierboxen für Kreuzungs-T-Stück

Article number	Box	Type
ISO-BOX	1 pc.	124x124x55mm

### Type: 33P



Nickel plated press-fit adapter to eurocone, 90°  
 Aansluiting met wartel en euroconus-koppeling vernikkeld, 90°  
 Raccord à visser eurocone nickelé, 90°  
 Anschlussverschraubung mit Eurokonus vernickelt, 90°

Article number	Bag / Box	Type
33P-1605	10 pc. / 60 pc.	16x3/4"



## A. P

### Type: 34P



Henco press swivel adapter with flat sealing, 90°

Aansluiting met wartel vlakdichtend, 90°

Raccord à visser joint plat, 90°

Anschlussverschraubung mit AG flachdichtend, 90°

Article number	Bag / Box	Type
34P-1604	10 pc. / 120 pc.	16x1/2"
34P-3206	5 pc. / 40 pc.	32x1"

### Type: 34P-CS (CW724)



Henco press swivel adapter with flat sealing, 90°

Aansluiting met wartel vlakdichtend, 90°

Raccord à visser joint plat, 90°

Anschlussverschraubung mit AG flachdichtend, 90°

Article number	Bag / Box	Type
34P-1605-CS	10 pc. / 120 pc.	16x3/4"
34P-2004-CS	10 pc. / 80 pc.	20x1/2"
34P-2005-CS	10 pc. / 80 pc.	20x3/4"
34P-2605-CS	10 pc. / 70 pc.	26x3/4"

### Type: 35P



Press-fit adapter to copper press (M-profile)

Overgangsstuk Henco pers naar koper pers (M-profiel)

Manchon à sertir vers cuivre à sertir (profil M)

Pressfitting Henco zu Pressfitting für Kupferrohr (M-profile)

Article number	Bag / Box	Type
35P-1615P	10 pc. / 150 pc.	16x15Cu M-profile
35P-2022P	10 pc. / 80 pc.	20x22Cu M-profile
35P-3228P	5 pc. / 50 pc.	32x28Cu M-profile

TILL EXHAUSTION OF STOCK

### Type: 36P (CW724)



Press-fit adapter to copper press or thin steel (V, M & SA-profile)

Overgangsstuk Henco pers naar koper pers of dunwandig staal (V, M & SA-profiel)

Manchon à sertir vers cuivre à sertir (profil M, V & SA)

Pressfitting Henco zu Pressfitting für Kupferrohr oder dünnwandig Stahl (Presskontur M, V & SA)

Article number	Bag / Box	Type
36P-1612P	10 pc. / 160 pc.	16x12Cu
36P-1614P	10 pc. / 150 pc.	16x14Cu
36P-1615P	10 pc. / 150 pc.	16x15Cu
36P-1616P	10 pc. / 150 pc.	16x16Cu
36P-2015P	10 pc. / 120 pc.	20x15Cu
36P-2018P	10 pc. / 120 pc.	20x18Cu
36P-2022P	10 pc. / 80 pc.	20x22Cu
36P-2620P	10 pc. / 70 pc.	20x20Cu
36P-2622P	10 pc. / 70 pc.	26x22Cu
36P-2628P	10 pc. / 70 pc.	26x28Cu
36P-3228P	5 pc. / 50 pc.	32x28Cu





**Type: 37P**

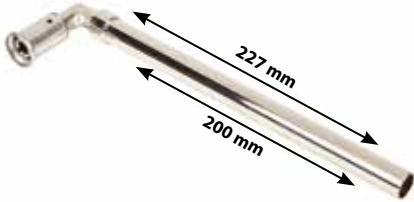

Press-fit adapter to copper pipe, elbow  
 Persfitting verlengd met koperbuis, knie  
 Coude à sertir avec tube en cuivre soudé  
 Pressfitting mit geschweisstem Kupferrohr, Winkel

Article number	Bag / Box	Type
37P-1412L	10 pc. / 60 pc.	14x12 (227/200mm)
37P-1612L	10 pc. / 60 pc.	16x12 (227/200mm)
37P-1615L	10 pc. / 60 pc.	16x15 (227/200mm)

**Type: 39P**



Double bend for radiator nickel-plated 300 mm copper pipe Ø15, connected end  
 Dubbele radiatorbocht koperbuis Ø15, 300 mm, vernikkeld, doorverbonden einde  
 Double courbe radiateur nickelé 300 mm tube en cuivre, bout rattaché  
 Doppelter Heizkörperwinkel vernickelt 300 mm Kupferrohr Ø15, durchgestelltes Ende

Article number	Bag / Box	Typ
39P-160450	1 pc. / 8 pc.	16x1/2" (AS = 50 mm)

*Interaxis 50 mm*

**Type: 40P**



Press-fit elbow to copper compression  
 Knie Henco pers x koperbuis knelkoppeling  
 Coude à sertir x tube en cuivre manchon à visser, 90°  
 Winkel Henco Press x Klemmverbinder für Kupferrohr

Article number	Bag / Box	Type
40P-1615S	10 pc. / 60 pc.	16x15 Cu
40P-2022S	10 pc. / 60 pc.	20x22 Cu
40P-2622S	10 pc. / 60 pc.	26x22 Cu

**Type: 41P**



Brass press coupling with valve F-connection  
 Messing perskoppeling met F-aansluiting  
 Connecteur F à sertir  
 Pressfitting mit F-Connection

Article number	Bag / Box	Type
41P-16	10 pc. / 40 pc.	16
41P-20	10 pc. / 40 pc.	20
41P-26	10 pc. / 40 pc.	26

BA-F41  
(p. 105)

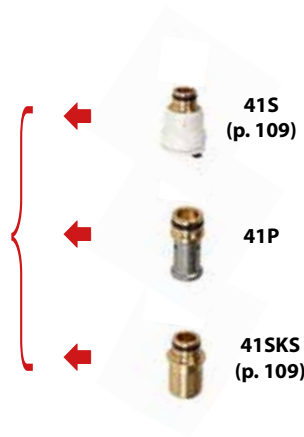



## A. P

### Type: 42P



Straight coupling PEX  
 Doorverbinder recht PEX  
 Manchon PEX  
 Kupplung PEX

Article number	Bag / Box	Type
42P-161615	10 pc. / 200 pc.	16x16x15
42P-202019	10 pc. / 140 pc.	20x20x19

### Type: 43P



T-piece Henco press 16 x compression 15 x Henco press 16  
 T-stuk Henco pers 16 x koper knel 15 x Henco pers 16  
 Pièce en T Henco sertir 16 x manchon à visser 15 x Henco sertir 16  
 T-Stuck Henco Press 16 x Klemmverbinder 15 x Henco Press 16

Article number	Bag / Box	Type
43P-161516	2 pc. / 50 pc.	16x15x16

### Type: 44P



Angle connection concealed cistern  
 Haakse aansluiting inbouwreservoir  
 Réservoir à encastrer à raccordement d'angle  
 Winkelanschluss UP-Spülkasten

Article number	Bag / Box	Type
44P-1604	10 pc. / 60 pc.	16x1/2"

### Type: 45P



Straight connection for concealed cistern  
 Rechte aansluiting voor inbouwreservoir  
 Raccordement droit pour réservoir encastré  
 Grader Anschluss für UP-Spülkasten

Article number	Bag / Box	Type
45P-1604	10 pc. / 150 pc.	16x1/2"

### Type: 52P



Easy mounting/repair fitting  
 Eenvoudige montage/reparatie fitting  
 Raccord montage/réparation facile  
 Einfache Montage/Reparatur Fitting

Article number	Bag / Box	Type
52P16	1 pc. / 40 pc.	16x16
52P20	1 pc. / 30 pc.	20x20
52P26	1 pc. / 30 pc.	26x26
52P32	1 pc. / 30 pc.	32x32

for Ø40, 50 and 63: chapter 2, article 53PK



## Type: WALL BOX

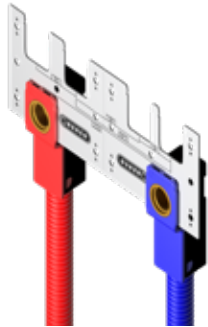

### Wall box PRESS

Article number	Box / Big box	Type
WBP-1604-RO	10 pc. / 300 pc.	16x1/2"
WBP-1604-BL	10 pc. / 300 pc.	16x1/2"
WBP-2004-RO	10 pc. / 300 pc.	20x1/2"
WBP-2004-BL	10 pc. / 300 pc.	20x1/2"

*Without mounting bracket 'WB-PLATE'*



Instruction video

## Type: WB-PLATE

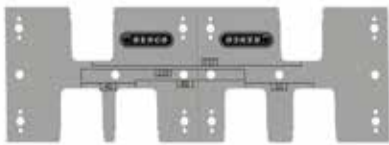

Wall Box mounting bracket  
Wall Box montage plaat  
Wall Box plaque de montage  
Wall Box Montage Bügel

Article number	Bag / Box	Type
WBPL-X	10 pc. / 60 pc.	

## Type: P-PIPESTOP



Stop end press for pipe  
Eindstop voor buis pers  
Bouchon à sertir pour tube  
Endkappe Press für Rohre

Article number	Bag / Box	Type
P-PIPESTOP16	10 pc. / 250 pc.	16x2
P-PIPESTOP20	10 pc. / 200 pc.	20x2
P-PIPESTOP26	10 pc. / 120 pc.	26x3
P-PIPESTOP32	10 pc. / 70 pc.	32x3



## B. PG

Gas: only allowed in countries where has been a HENCO GAS testing + certificate is available! (See [www.henco.be](http://www.henco.be))  
 Gas: enkel toegelaten in landen waar er een HENCO GAS keur is + certificaat voorhanden is! (Zie [www.henco.be](http://www.henco.be))  
 Gaz: seulement permis dans des pays où le contrôle a eu lieu + certificat est disponible! (Consultez [www.henco.be](http://www.henco.be))  
 Gas: nur zugelassen in Länder wo HENCO GAS Prüfung geschehen ist + Zertifikat vorhanden ist! (Siehe [www.henco.be](http://www.henco.be))

Henco brass press fittings for gas in combination with standard pipes gas, see page 17



### Type: 1PG



Elbow 90°  
 Knie 90°  
 Coude 90°  
 Winkel 90°

Article number	Bag / Box	Type
1PG-1616	10 pc. / 150 pc.	16x16
1PG-2020	10 pc. / 80 pc.	20x20
1PG-2626	5 pc. / 50 pc.	26x26
1PG-3232	5 pc. / 50 pc.	32x32

### Type: 2PG



Backplate elbow female  
 Muurplaat binnendraad  
 Culasse femelle  
 Wandscheibe IG

Article number	Bag / Box	Type
2PG-1604	10 pc. / 50 pc.	16x1/2" (52 mm)
2PG-2004	10 pc. / 50 pc.	20x1/2" (52 mm)
2PG-2005	10 pc. / 50 pc.	20x3/4" (52mm)
2PG-2605	5 pc. / 50 pc.	26x3/4" (52 mm)

### Type: 2PG-K



Backplate elbow female, short model  
 Muurplaat binnendraad, laag  
 Culasse femelle, modèle court  
 Wandscheibe IG, kurzes Modell

Article number	Bag / Box	Type
2PG-1604K	10 pc. / 50 pc.	16x1/2" (35 mm)

### Type: 5PG



Elbow 90° male adapter  
 Knie 90° buitendraad  
 Coude 90° mâle  
 Winkel 90° AG

Article number	Bag / Box	Type
5PG-1604	10 pc. / 150 pc.	16x1/2"
5PG-2004	10 pc. / 100 pc.	20x1/2"
5PG-2005	10 pc. / 80 pc.	20x3/4"
5PG-2605	10 pc. / 60 pc.	26x3/4"



**Type: 6PG**



Elbow 90° female adapter  
Knie 90° binnendraad  
Coude 90° femelle  
Winkel 90° IG

Article number	Bag / Box	Type
6PG-1604	10 pc. / 120 pc.	16x1/2"
6PG-2004	10 pc. / 120 pc.	20x1/2"
6PG-2005	10 pc. / 50 pc.	20x3/4"
6PG-2605	5 pc. / 50 pc.	26x3/4"

**Type: 9PG**



T-piece  
T-stuk  
Pièce en T  
T-Stück

Article number	Bag / Box	Type
9PG-161616	10 pc. / 60 pc.	16x16x16
9PG-202020	10 pc. / 50 pc.	20x20x20
9PG-323232 *	1 pc. / 20 pc.	32x32x32

*\*TILL EXHAUSTION OF STOCK*

**Type: 10PG**



T-reduced centre  
T-verlopend  
Pièce en T-réduit  
T-reduziert

Article number	Bag / Box	Type
10PG-262026	5 pc. / 30 pc.	26x20x26

**Type: 11PG**



T-branch and line reduced  
T-2X verlopend  
Pièce en T 2X réduit  
T-2X reduziert

Article number	Bag / Box	Type
11PG-201616	10 pc. / 50 pc.	20x16x16

**Type: 13PG**



T-female centre  
T-binnendraad  
Pièce en T femelle  
T-IG

Article number	Bag / Box	Type
13PG-200420	10 pc. / 50 pc.	20x1/2"x20
13PG-260426	5 pc. / 30 pc.	26x1/2"x26
13PG-260526	5 pc. / 30 pc.	26x3/4"x26





## B. PG

### 1 Type: 15PG

2

3

4

5

6

7



**Straight coupling**  
**Doorverbinder recht / perssok**  
**Manchon**  
**Kupplung**

Article number	Bag / Box	Type
15PG-1616	10 pc. / 200 pc.	16x16
15PG-2020	10 pc. / 140 pc.	20x20
15PG-2626	5 pc. / 80 pc.	26x26
15PG-3232	5 pc. / 50 pc.	32x32

### 8 Type: 16PG

9

10

11

12



**Reducing coupling**  
**Verloopstuk**  
**Réduction**  
**Kupplung-reduziert**

Article number	Bag / Box	Type
16PG-2016	10 pc. / 150 pc.	20x16
16PG-2620	5 pc. / 80 pc.	26x20
16PG-3226	5 pc. / 40 pc.	32x26

### Type: 17PG



**Straight male adapter**  
**Recht aansluitstuk buitendraad / Puntstuk**  
**Raccord droit mâle**  
**Übergangsfitting AG**

Article number	Bag / Box	Type
17PG-1604	10 pc. / 150 pc.	16x1/2"
17PG-2004	10 pc. / 150 pc.	20x1/2"
17PG-2005	10 pc. / 150 pc.	20x3/4"
17PG-2605	5 pc. / 80 pc.	26x3/4"
17PG-2606	5 pc. / 80 pc.	26x1"
17PG-3206	5 pc. / 50 pc.	32x1"



**Type: 18PG**



**Straight female adapter**  
**Recht aansluitstuk binnendraad / Schroefbus**  
**Raccord droit femelle**  
**Übergangsfitting IG**

Article number	Bag / Box	Type
18PG-1604	10 pc. / 150 pc.	16x1/2"
18PG-2004	10 pc. / 100 pc.	20x1/2"
18PG-2005	10 pc. / 100 pc.	20x3/4"
18PG-2605	5 pc. / 80 pc.	26x3/4"
18PG-2606	5 pc. / 50 pc.	26x1"
18PG-3206	5 pc. / 50 pc.	32x1"

**Type: 30PG**



**Press-fit adapter to copper compression**  
**Overgangsstuk Henco pers x koperbuis knelkoppeling**  
**Manchon henco à sertir x tube de cuivre manchon à visser**  
**Pressfitting x Klemmverbinder für Kupferrohr**

Article number	Bag / Box	Type
30PG-1615S-2	10 pc. / 120 pc.	16x15 Cu
30PG-2022S	10 pc. / 100 pc.	20x22 Cu
30PG-2622S	10 pc. / 80 pc.	26x22 Cu

**Type: 36PG**



**Press-fit adapter to copper press (V, M & SA-profile)**  
**Overgangsstuk Henco pers naar koper pers (V, M & SA-profiel)**  
**Manchon à sertir vers cuivre à sertir (profil M, V & SA)**  
**Pressfitting Henco zu Pressfitting für Kupferrohr (Presskontur M, V & SA)**

Article number	Bag / Box	Type
36PG-1615P	10 pc. / 150 pc.	16x15Cu
36PG-2015P	10 pc. / 120 pc.	20x15Cu
36PG-2022P	10 pc. / 80 pc.	20x22Cu
36PG-2615P	10 pc. / 80 pc.	26x15Cu
36PG-2622P	10 pc. / 70 pc.	26x22Cu

- 1
- 2
- 3
- 4**
- 5
- 6
- 7
- 8
- 9
- 10
- 11
- 12

**BRASS COMPRESSION FITTINGS - MESSING SCHROEFKOPPELINGEN  
RACCORDS À VISSER - SCHRAUBFITTINGE**





### Type: 1



**Straight male adapter**  
**Recht aansluitstuk buitendraad / Puntstuk**  
**Raccord droit mâle**  
**Kupplung AG**

Article number	Bag / Box	Type
1-1604-S	10 pc. / 180 pc.	16x1/2" + o-ring
1-1605-S	10 pc. / 250 pc.	16x1/2"
1-1605-S	10 pc. / 150 pc.	16x3/4"
1-1804-S	10 pc. / 150 pc.	18x1/2" + o-ring
1-1805 *	10 pc. / 150 pc.	18x3/4"
1-2004-S	10 pc. / 150 pc.	20x1/2" + o-ring
1-2004-ZS	10 pc. / 150 pc.	20x1/2"
1-2005-S	10 pc. / 150 pc.	20x3/4"
1-2605-S	5 pc. / 80 pc.	26x3/4"
1-2606-S	5 pc. / 80 pc.	26x1"
1-3206-S	5 pc. / 80 pc.	32x1"

*\* TILL EXHAUSTION OF STOCK*

### Type: 2



**Straight coupling**  
**Doorverbinder recht**  
**Manchon**  
**Kupplung doppelt**

Article number	Bag / Box	Type
2-1616-S	10 pc. / 200 pc.	16x16
2-2020-S	10 pc. / 120 pc.	20x20

### Type: 3



**Straight female adapter**  
**Recht aansluitstuk binnendraad / Schroefbus**  
**Raccord droit femelle**  
**Kupplung IG**

Article number	Bag / Box	Type
3-1604-S	10 pc. / 170 pc.	16x1/2"
3-1804-S	10 pc. / 120 pc.	18x1/2"
3-2004-S	10 pc. / 120 pc.	20x1/2"
3-2005-S	10 pc. / 120 pc.	20x3/4"
3-2605-S	5 pc. / 80 pc.	26x3/4"
3-2606-S	5 pc. / 80 pc.	26x1"

### Type: 4



**Elbow 90°**  
**Knie 90°**  
**Coude 90°**  
**Winkel 90°**

Article number	Bag / Box	Type
4-1616-S	10 pc. / 110 pc.	16x16
4-2020-S	10 pc. / 60 pc.	20x20
4-2626-S	10 pc. / 40 pc.	26x26



1  
2  
3  
4  
**5**  
6  
7

**Type: 5**



**Elbow 90° male adapter**  
**Knie 90° buitendraad**  
**Coude 90° mâle**  
**Winkel 90° AG**

Article number	Bag / Box	Type
5-1604-S	10 pc. / 150 pc.	16x1/2"
5-1804 *	10 pc. / 100 pc.	18x1/2"
5-2005	10 pc. / 100 pc.	20x3/4"
5-2606	5 pc. / 40 pc.	26x1"

*\* TILL EXHAUSTION OF STOCK*

8  
9  
10  
11  
12

**Type: 6**



**Elbow 90° female adapter**  
**Knie 90° binnendraad**  
**Coude 90° femelle**  
**Winkel 90° IG**

Article number	Bag / Box	Type
6-1604-S	10 pc. / 150 pc.	16x1/2"
6-1804 *	10 pc. / 90 pc.	18x1/2"
6-2005-S	10 pc. / 80 pc.	20x3/4"

*\* TILL EXHAUSTION OF STOCK*

**Type: 7**



**Backplate elbow with branch connection**  
**Sanitair muurplaat binnendraad**  
**Culasse pour sanitaire femelle**  
**Sanitär Wandscheibe**

Article number	Bag / Box	Type
7-1604-S	10 pc. / 80 pc.	16x1/2"

**Type: 8**



**T-piece**  
**T-stuk**  
**Piece en T**  
**T-Stück**

Article number	Bag / Box	Type
8-1616-S	10 pc. / 70 pc.	16x16x16

**Type: 9**



**T-female branch**  
**T-binnendraad**  
**Pièce en T femelle**  
**T-IG**

Article number	Bag / Box	Type
9-160416	10 pc. / 80 pc.	16x1/2"x16
9-200520A	10 pc. / 40 pc.	20x3/4"x20





### Type: 10



**Nut, insert and jointing ring**  
**Moer, Insert en klemring**  
**Ecrou, insert et bîcône**  
**Mutter, Stutzhûse und Klemmring**

Article number	Bag / Box	Type
10-16045N	10 pc. / 300 pc.	16x1/2"

TILL EXHAUSTION OF STOCK

### Type: 13-2



**Nut, insert and jointing ring to copper compression**  
**Adapter Henco buis naar messing knelverbinding**  
**Raccord à visser cuivre vers multicouche**  
**Verbindungsstück Kupfer Schraubfitting auf Henco**

Article number	Bag / Box	Type
13-1415-2 *	2 pc. / 200 pc.	14x15 Cu
13-1615A-2 *	2 pc. / 200 pc.	16x15 Cu
13-1615HA-2	2 pc. / 200 pc.	16x15 Cu
13-2022HA-2	2 pc. / 120 pc.	20x22 Cu
13-2628H-2	2 pc. / 80 pc.	26x28 Cu

\* Nickel plated nut

### Type: 13-VH



**Adapter for Henco compression 26mm to copper compression 22mm**  
**Adapter Henco buis 26mm naar messing knelverbinding 22mm**  
**Adapteur raccord à visser cuivre 22mm vers multicouche 26mm**  
**Verbindungsstück für Henco Schraubfitting 26mm auf Kupfer Schraubfitting 22mm**

Article number	Bag / Box	Type
13-V2622H-2	2 pc. / 70 pc.	26x22 Cu

### Type: 24



**Compression coupling Henco x copper tube**  
**Overgangsstuk Henco knel x koperbuis knelverbinding**  
**Raccord droit Henco x tube de cuivre manchon à visser**  
**Gerade Fitting Henco x Klemmverbinder für Kupferrohr**

Article number	Bag / Box	Type
24-1615-S	10 pc. / 200 pc.	16x15 Cu
24-2022	10 pc. / 100 pc.	20x22 Cu
24-2622	5 pc. / 50 pc.	26x22 Cu

### Type: 28



**T-reduced centre**  
**T-verlopend**  
**Pièce en T réduit**  
**T-reduziert**

Article number	Bag / Box	Type
28-201620	5 pc. / 50 pc.	20x16x20



1 **Type: EK**



Nickel plated eurocone (3/4" F)  
 Euroconus schroefkoppeling (3/4" F)  
 Raccord à visser eurocone (3/4" F)  
 Schraubfitting Eurokonus (3/4" F)

Article number	Bag / Box	Type
EK12-2	2 pc. / 100 pc.	Ø12
EK14-2	2 pc. / 100 pc.	Ø14
EK16-2	2 pc. / 100 pc.	Ø16
EK17-2	2 pc. / 100 pc.	Ø17
EK18-2	2 pc. / 100 pc.	Ø18
EK20-2	2 pc. / 100 pc.	Ø20

2  
3  
4  
5  
6  
7  
8 **Type: EKH**



Brass eurocone (3/4" F)  
 Euroconus-schroefkoppeling (3/4" F) niet vernikkeld  
 Raccord à visser eurocone (3/4" F) laiton non nickelé  
 Schraubfitting Eurokonus (3/4" F) Messing nicht vernickelt

Article number	Bag / Box	Type
EKH16-2	2 pc. / 100 pc.	Ø16

9  
10  
11  
12 **Type: EK15**



Eurocone (3/4" F) for copper tube 15mm  
 Euroconus-schroefkoppeling (3/4" F) voor koperbuis 15mm  
 Raccord à visser eurocone (3/4" F) pour tube de cuivre 15mm  
 Schraubfitting Eurokonus (3/4" F) für Kupferrohr 15mm

Article number	Bag / Box	Type
EK15	25 pc. / 400 pc.	Ø15

**Type: SPLIT-S**



Split ring for compression fittings (not for EK)  
 Klemring voor schroeffittingen (niet voor EK)  
 Anneau de serrage pour raccords à visser (pas pour EK)  
 Klemring für Schraubfitting (nicht für EK)

Article number	Bag	Type
SPLIT-S16	10 pc.	Ø16
SPLIT-S20	10 pc.	Ø20

**Type: AB**



Elbow 90° eurocone elbow (3/4" M)  
 Knie 90° voor euroconus-aansluiting (3/4" M)  
 Coude 90° pour raccordement eurocone (3/4" M)  
 Winkel 90° für Eurokonusanschluß (3/4" M)

Article number	Bag / Box	Type
AB1420	10 pc. / 100 pc.	3/4"x3/4" for EK



### Type: ABE



Elbow 90° eurocone (3/4" M) x 1/2" male adapter  
 Knie 90° buitendraad 1/2 x euroconus-aansluiting (3/4" M)  
 Coude 90° mâle 1/2" x raccordement eurocone (3/4" M)  
 Winkel 90° AG 1/2 x Eurokonusanschluss (3/4" M)

Article number	Bag / Box	Type
ABEK04	10 pc. / 150 pc.	1/2"x3/4"

### Type: AT



Eurocone equal T  
 T voor euroconus-aansluiting (3/4" M)  
 Pièce en T pour raccordement eurocone (3/4" M)  
 T für Eurokonusanschluß (3/4" M)

Article number	Bag / Box	Type
AT1420	10 pc. / 100 pc.	3/4"x3/4"x3/4"

### Type: AD



Eurocone straight coupling (3/4" M)  
 Euroconus nippel (3/4" M)  
 Mamelon 2x raccordement eurocone (3/4" M)  
 Nippel für 2x Eurokonusanschluss

Article number	Bag / Box	Type
AD-EKEK	10 pc. / 250 pc.	3/4"x3/4" for

### Type: AN



Straight eurocone connection (3/4" M) to 1/2" male adapter  
 Recht overgangsstuk 1/2" M met O-ring en -aansluiting (3/4" M)  
 Manchon droit mâle 1/2" avec o-ring et eurocone  
 Nippel AG 1/2" mit O-ring und Eurokonusanschluss (3/4" M)

Article number	Bag / Box	Type
AN1420	10 pc. / 250 pc.	1/2"x3/4" for

1

2

3

4

5

6

7

8

9

10

11

12



1 **Type: 3EK**



Double backplate elbow female, 2x eurocone connection  
 Doorstroom muurplaat binnendraad, 2x euroconus-aansluiting  
 Culasse double, 2x raccordement eurocone  
 Wandscheibe doppelt IG, 2x Eurokokusanschluss

Article number	Bag / Box	Type
3EK-050405	5 pc. / 40 pc.	3/4"x1/2"x3/4" (50 mm)

2

3

4

5

6

7

8

**Type: WALL BOX**

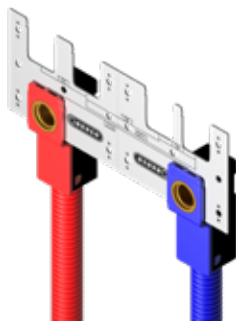

Wall box COMPRESSION  
 Wall box SCHROEF  
 Wall box COMPRESSION  
 Wall box SCHRAUBE

Article number	Box / Big box	Type.
WBS-1604-RO	10 pc. / 300 pc.	16x1/2"
WBS-1604-BL	10 pc. / 300 pc.	16x1/2"

*Without mounting bracket WB-PLATE*



*Instruction video*

9

10

11

12

**Type: WB-PLATE**

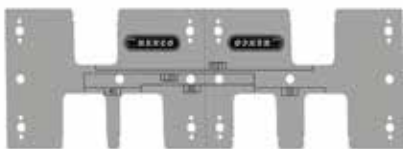

Wall Box mounting bracket  
 Wall Box montage plaat  
 Wall Box plaque de montage  
 Wall Box Montage Bügel

Article number	Bag / Box	Type
WBPL-X	10 pc. / 60 pc.	

**Type: 2C**



Wall plate horizontal  
 Horizontale / rechtdoor muurplaat - wanddoorvoer  
 Culasse horizontale  
 Wandscheibe horizontal - Wanddurchführung

Article number	Bag / Box	Type
2C-0404	10 pc. / 100 pc.	1/2"x1/2"





	<i>Page</i>
<b>A. FULL FLOW MANIFOLD</b>	<b>96</b>
<b>B. BRASS</b>	<b>101</b>





## A. FULL FLOW MANIFOLD

### Type: VSKEK-0502



2-group basic part with 2 eurocone connections 3/4"  
 2-groeps basis deel met 2 euroconus-aansluitingen 3/4"  
 Section de base à 2 groupes avec 2 raccords eurocone 3/4"  
 2-gruppiges Basisprofil mit 2 Eurokonusanschlüssen 3/4"

Article number	Bag / Box	Type
VSKEK-0502	10 pc. / 30 pc.	2x3/4"

### Type: VSKEK-0503



3-group basic part with 3 eurocone connections 3/4"  
 3-groeps basis deel met 3 euroconus-aansluitingen 3/4"  
 Section de base à 3 groupes avec 3 raccords eurocone 3/4"  
 3-gruppiges Basisprofil mit 3 Eurokonusanschlüssen 3/4"

Article number	Bag / Box	Type
VSKEK-0503	10 pc. / 30 pc.	3x3/4"

### Type: 19SK



Push fitting with eurocone connection  
 Steekkoppeling met euroconus-aansluiting  
 Raccord push fit avec eurocone  
 Steckkupplung mit Eurokonus

Article number	Bag / Box	Type
19SK-1505	10 pc. / 80 pc.	15x3/4"
19SK-1605	10 pc. / 80 pc.	16x3/4"
19SK-2005	10 pc. / 80 pc.	20x3/4"

### Type: 26SK



Push fitting with swivel and flat sealing  
 Steekkoppeling met wartel en vlakke dichting  
 Raccord push fit avec raccord ecrou étanchéité plate  
 Steckkupplung mit Drehbar und flach Versiegelung

Article number	Bag / Box	Type
26SK-1605	10 pc. / 80 pc.	16x3/4"
26SK-2005	10 pc. / 80 pc.	20x3/4"

### Type: VVSK



Straight entry piece  
 Voeding voor verdeler  
 Départ collecteur  
 Eingang für Verteiler

Article number	Bag / Box	Type
VVSK-20	10 pc. / 80 pc.	20
VVSK-26	10 pc. / 80 pc.	26

## A. FULL FLOW MANIFOLD



### Type: VVSK-TM



T-piece for supply for manifold  
 Aanvoer T-stuk direct op verdeler  
 Départ pièce en T pour collecteur  
 T-Stück für Vorlauf für Verteiler

Article number	Bag / Box	Type
VVSK-T20M20	10 pc. / 30 pc.	20-20
VVSK-T26M26	5 pc. / 20 pc.	26-26

### Type: 17SKS



Straight nipple male (brass)  
 Recht aansluitstuk buitendraad (messing)  
 Raccord droit mâle (laiton)  
 Übergangsfitting AG (Messing)

Article number	Bag / Box	Type
17SKS-2004	5 pc. / 150 pc.	20 x 1/2"
17SKS-2005	5 pc. / 150 pc.	20 x 3/4"
17SKS-2604	5 pc. / 100 pc.	26 x 1/2"
17SKS-2605	5 pc. / 100 pc.	26 x 3/4"

*Applicable with HENCO Vision fittings & manifolds*

### Type: 18SKS



Straight nipple female (brass)  
 Recht aansluitstuk binnendraad (messing)  
 Raccord droit femelle (laiton)  
 Übergangsfitting IG (Messing)

Article number	Bag / Box	Type
18SKS-2004	5 pc. / 150 pc.	20 x 1/2"
18SKS-2005	5 pc. / 100 pc.	20 x 3/4"
18SKS-2604	5 pc. / 100 pc.	26 x 1/2"
18SKS-2605	5 pc. / 80 pc.	26 x 3/4"

*Applicable with HENCO Vision fittings & manifolds*

### Type: VVSK-90



Elbow 90° push fitting for supply VVSK  
 Knie 90° steekfitting voor aanvoer VVSK  
 Coude 90° raccord push pour entrée VVSK  
 Winkel 90° push fitting für Zufuhr VVSK

Article number	Bag / Box	Type
VVSK-20-90	10 pc. / 70 pc.	20-90
VVSK-26-90	10 pc. / 50 pc.	26-90



## A. FULL FLOW MANIFOLD

### 1 Type: VVSK-T



T-piece push fitting for supply VVSK  
 T-stuk steekfitting voor aanvoer VVSK  
 Piece en T raccord push pour entrée VVSK  
 T-Stück push fitting für Zufuhr VVSK

Article number	Bag / Box	Type
VVSK-T202020	10 pc. / 40 pc.	20-20-20
VVSK-T262626	10 pc. / 20 pc.	26-26-26

### 6 Type: VS-ENDCAP



Endcap female for manifold  
 Eindkap binnendraad voor verdeler  
 Bouchon femelle pour collecteur  
 Endkappe IG für Verteiler

Article number	Bag / Box	Type
VS-ENDCAP	10 pc. / 180 pc.	F

### 12 Type: 18EK05-03



3/4" eurocone connection x 3/8" brass female thread  
 3/4"euroconusaansluiting x 3/8" messing binnendraad  
 Raccord conique 3/4" euro x filetage femelle 3/8" laiton  
 3/4" Eurokonus-Anschluss x 3/8" Messing-Innengewinde

Article number	Bag / Box	Type
18EK05-03	2 st. / 200 st.	EKx3/8"

### Type: VDEK-T05



T-piece connection 2x eurocone 3/4" to male thread of manifold  
 T-stuk aansluiting 2x euroconus 3/4" op buitendraad van verdeler  
 Raccordement en T 2x eurocone 3/4" au filetage mâle du distributeur  
 T-Stück Anschluss 2x Eurokonus 3/4" an Außengewinde des Verteilers

Article number	Bag / Box	Type
VDEK-T05	10 st. / 50 st.	

### Type: VS-ENDCAP-M



End plugmale for manifold  
 Eindstop buitendraad voor verdeler  
 Bouchon mâle pour collecteur  
 Endkappe AG für Verteiler

Article number	Bag / Box	Type
VS-ENDCAP-M	10 pc. / 150 pc.	M

## A. FULL FLOW MANIFOLD



### Type: ENDCAP-EK05



Eurocone endcap 3/4" white  
Euroconus-eindkap 3/4" wit  
Eurocone bouchon 3/4" blanc  
Eurokonus Endkappe 3/4" Weiss

Article number	Bag / Box	Type
ENDCAP-EK05	10 pc. / 200 pc.	3/4"

### Type: VDSK



Through-connector for mounting on male thread distributor  
Doorverbinder voor montage op buitendraad verdeler  
Connecteur traversant pour montage sur collecteur à filetage mâle  
Durchgangsverteiler zur Montage auf Außengewinde verteilern

Article number	Bag / Box	Type
VDSK-20	10 pc. / 80 pc.	20
VDSK-26	10 pc. / 60 pc.	26

### Type: SK-STOPCLIP



Reusable stop and clip for push fit connection  
Herbruikbare stop en clip passend in een steekkoppeling  
Bouchon et clip réutilisables pour connection push fit  
Stopfen und clip für Steckanschluss, wieder verwendbar

Article number	Bag / Box	Type
SK-STOPCLIP16	10 pc. / 120 pc.	16
SK-STOPCLIP20	10 pc. / 100 pc.	20
SK-STOPCLIP26	10 pc. / 80 pc.	26

### Type: SK-B05



Bracket for Vision manifolds  
Montagebeugel voor Vision verdelers  
Double support pour collecteurs Vision  
Halter für Vision Verteiler

Article number	Bag / Box	Typ
SK-B05	1 pc. / 200 pc.	B05

### Type: VVPK



Straight entry piece - press  
Voeding voor verdeler - pers  
Arrivée pour collecteur - à sertir  
Eingang für Verteiler - press

Article number	Bag / Box	Typ
VVPK-20	10 pc. / 80 pc.	20
VVPK-26	10 pc. / 70 pc.	26



## A. FULL FLOW MANIFOLD

### Type: VVPK90-D



Bend entry piece down 90° - press  
 Voeding verdeler bocht 90° toevoer onder - pers  
 Départ dessous pour collecteur coude 90° - à sertir  
 Eingang für Verteiler Winkel 90° nieder - press

Article number	Bag / Box	Type
VVPK90-20-D	10 pc. / 70 pc.	20-90
VVPK90-26-D	10 pc. / 50 pc.	26-90

### Type: VVPK90-U



Bend entry piece up 90° - press  
 Voeding verdeler bocht 90° graden boven - pers  
 Départ par dessus pour collecteur coude 90° - à sertir  
 Eingang für Verteiler Winkel 90° oben - press

Article number	Bag / Box	Type
VVPK90-20-U	10 pc. / 70 pc.	20-90
VVPK90-26-U	10 pc. / 50 pc.	26-90

### POSSIBLE COMBINATIONS

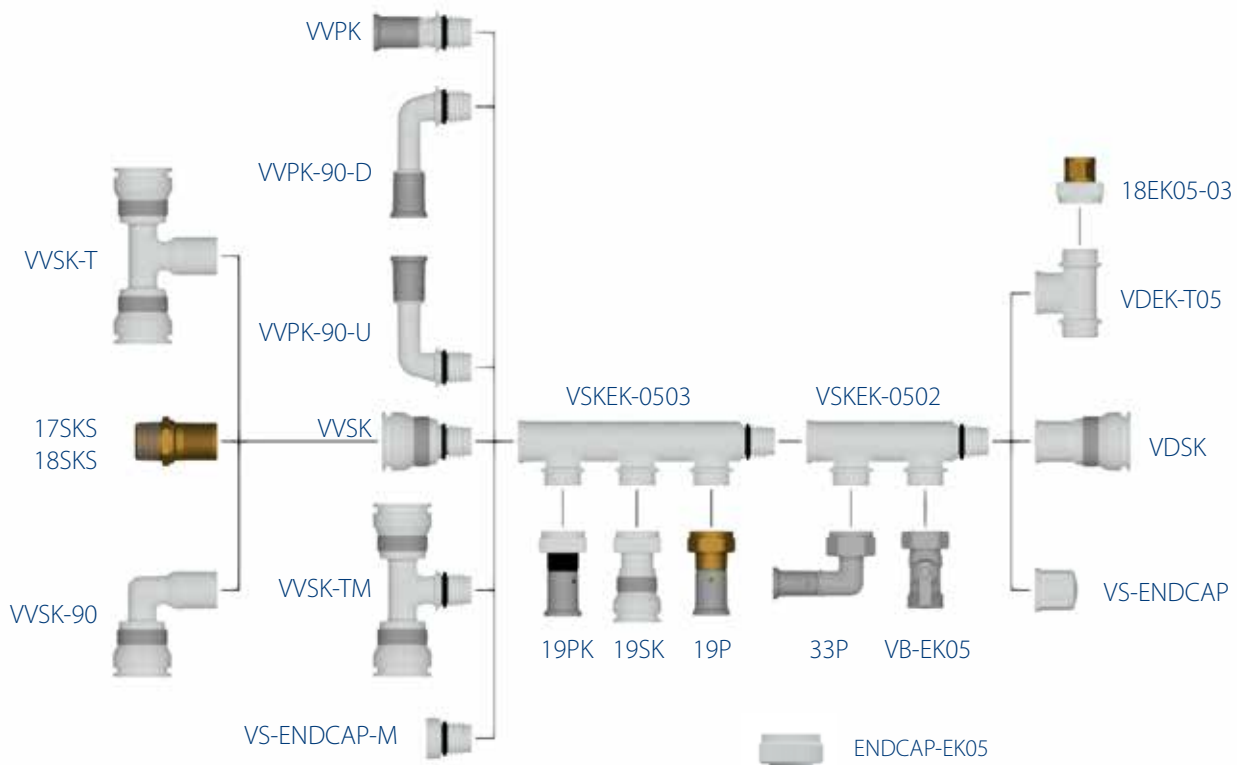





**Type: V-06**

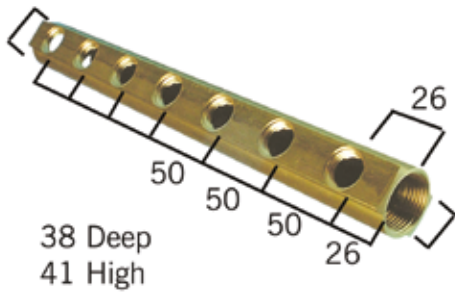

**Manifold 1", 1/2" female thread, 3/8" air vent hole**  
**Verdeler 1", 1/2" aansluitingen, 3/8" ontluichtingsopening**  
**Collecteur 1", conn. 1/2" femelle, conn. 3/8" pour purgeur**  
**Verteiler 1", 1/2" IG, 3/8" Loch für Entlüftung**

Article number	Bag / Box	Type
V-060402	1 pc. / 64 pc.	1" 2x1/2" x 3/8"
V-060404	1 pc. / 30 pc.	1" 4x1/2" x 3/8"
V-060405	1 pc. / 28 pc.	1" 5x1/2" x 3/8"
V-060406	1 pc. / 20 pc.	1" 6x1/2" x 3/8"
V-060408	1 pc. / 20 pc.	1" 8x1/2" x 3/8"

**Type: V-05-Z**

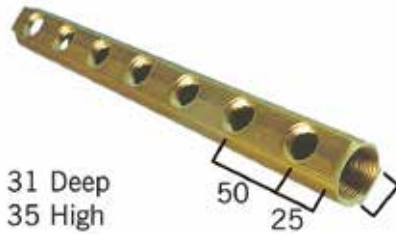

**Manifold 3/4", 1/2" female thread**  
**Verdeler 3/4", 1/2" aansluitingen**  
**Collecteur 3/4", conn. 1/2" femelle**  
**Verteiler 3/4", 1/2" IG**

Article number	Bag / Box	Type
V-050404-Z	1 pc. / 30 pc.	3/4" 4x1/2"

**Type: VEK-06**



**Manifold 1" with connections and one 3/8" air vent hole**  
**Verdeler 1" met EK-aansluitingen en 3/8" ontluichtingsopening**  
**Collecteur 1" avec des raccordements eurocone et un trou 3/8" pour purgeur**  
**Verteiler 1" mit -Anschlüssen und 3/8" Loch für Entlüftung**

Article number	Bag / Box	Type
VEK-060502	1 pc. / 48 pc.	1" 2x3/4" x 3/8"
VEK-060503	1 pc. / 32 pc.	1" 3x3/4" x 3/8"
VEK-060504	1 pc. / 20 pc.	1" 4x3/4" x 3/8"
VEK-060505	1 pc. / 21 pc.	1" 5x3/4" x 3/8"
VEK-060507	1 pc. / 20 pc.	1" 7x3/4" x 3/8"
VEK-060508	1 pc. / 20 pc.	1" 8x3/4" x 3/8"

**Type: VEK-06-Z**

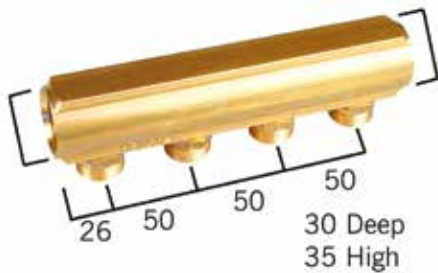

**Manifold 1" with eurocone connections**  
**Verdeler 1" met euroconus-aansluitingen**  
**Collecteur 1" avec des raccordements eurocone**  
**Verteiler 1" mit Eurokonus-Anschlüssen**

Article number	Bag / Box	Type
VEK-060503-Z	1 pc. / 32 pc.	1" 3x3/4"
VEK-060504-Z	1 pc. / 20 pc.	1" 4x3/4"
VEK-060505-Z	1 pc. / 21 pc.	1" 5x3/4"
VEK-060506-Z	1 pc. / 20 pc.	1" 6x3/4"
VEK-060507-Z	1 pc. / 20 pc.	1" 7x3/4"
VEK-060508-Z	1 pc. / 20 pc.	1" 8x3/4"
VEK-060509-Z	1 pc. / 15 pc.	1" 9x3/4"
VEK-060510-Z	1 pc. / 15 pc.	1" 10x3/4"



## B. BRASS

### 1 Type: H-0212

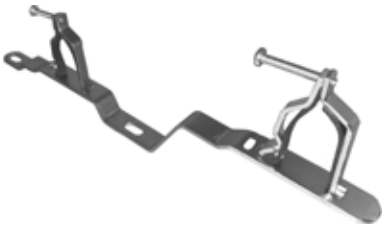

Manifold bracket, double, with rubber lining, for all manifolds  
 Ophangbeugel dubbel, met rubberen voering, voor alle verdelers  
 Support double avec revêtement en caoutchouc, pour tous les collecteurs  
 Verteiler-Halter doppelt, mit Gummierung, für alle Verteiler

Article number	Bag / Box	Type
H-0212	2 pc. / 25 x 2 pc.	3/4" - 1"

### 6 Type: H-0212-S



Manifold bracket, with rubber lining, for all manifolds  
 Ophangbeugel met rubberen voering, voor alle verdelers  
 Support avec revêtement en caoutchouc, pour tous les collecteurs  
 Verteiler-Halter mit Gummierung, für alle Verteiler

Article number	Bag / Box	Type
H-0212-S	1 pc. / 500 pc.	3/4" - 1"

### 10 Type: VS REDUCTIE



Manifold reducer with O-ring  
 Reductie met O-ring voor verdeler  
 Réduction avec O-ring pour collecteur  
 Reduktion für Verteiler mit O-ring

Article number	Bag / Box	Type
VS-0504	10 pc. / 500 pc.	3/4"x1/2"
VS-0604	10 pc. / 250 pc.	1"x1/2"
VS-0605	10 pc. / 250 pc.	1"x3/4"

### Type: VS BLINDSTOP



Manifold plug with O-ring  
 Blindstop met O-ring voor verdeler  
 Bouchon avec O-ring pour collecteur  
 Stopfen mit O-Ring für Verteiler

Article number	Bag / Box	Type
VS-05	10 pc. / 250 pc.	3/4"
VS-06	10 pc. / 200 pc.	1"
VS-07	10 pc. / 200 pc.	5/4"

### Type: VB-EK05



Ball valve, 2 x eurocone connection  
 Bolkraan, 2 x euroconus aansluiting  
 Vanne d'arrêt, 2 x raccordement eurocone  
 Kugelhahn, 2 x Eurokonus

Article number	Box / Big Box	Type
VB-EK05	25 pc. / 200 pc.	3/4" EK x 3/4" EK

### Type: VB-HANDLE



Handle for VB-EK05 ball valve and VB05 and VB06 manifolds  
 Hendel voor VB-EK05 bolkraan en VB05 en VB06 verdelers  
 Poignée à levier pour vanne d'arrêt VB-EK05 en les collecteurs VB05 et VB06  
 Kombigriffe für Kugelhahn VB-EK05 und VB05 und VB06 Verteiler

Article number	Box / Big Box	Type
VB-HANDLE-RED	1 pc. / 100 pc.	Red/Rood/Rouge/Rot
VB-HANDLE-BLUE	1 pc. / 100 pc.	Blue/Blauw/Bleu/Blau



**Type: VB05**



**Manifold 3/4" with ball valves and eurocone connection**  
**Verdeler 3/4" met bolkraan en euroconus-aansluiting**  
**Collecteur 3/4" avec vanne d'arrêt et eurocone**  
**Verteiler 3/4" mit Kugelhahnset und Eurokonus**

Article number	Bag / Box	Type
VB050502-BLAUW	5 pc. / 50 pc.	3/4"x2xEK14,16,18 & 20
VB050502-ROOD	5 pc. / 50 pc.	3/4"x2xEK14,16,18 & 20
VB050503-BLAUW	5 pc. / 50 pc.	3/4"x3xEK14,16,18 & 20
VB050503-ROOD	5 pc. / 50 pc.	3/4"x3xEK14,16,18 & 20
VB050504-BLAUW	4 pc. / 40 pc.	3/4"x4xEK14,16,18 & 20
VB050504-ROOD	4 pc. / 40 pc.	3/4"x4xEK14,16,18 & 20

**Type: VB06**



**Manifold 1" with ball valves and eurocone connection**  
**Verdeler 1" met bolkraan en euroconus-aansluiting**  
**Collecteur 1" avec vanne d'arrêt et eurocone**  
**Verteiler 1" mit Kugelhahnset und Eurokonus**

Article number	Bag / Box	Type
VB060502-BLAUW	5 pc. / 50 pc.	1"x2xEK14,16,18 & 20
VB060502-ROOD	5 pc. / 50 pc.	1"x2xEK14,16,18 & 20
VB060503-BLAUW	5 pc. / 40 pc.	1"x3xEK14,16,18 & 20
VB060503-ROOD	5 pc. / 40 pc.	1"x3xEK14,16,18 & 20
VB060504-BLAUW	4 pc. / 40 pc.	1"x4xEK14,16,18 & 20
VB060504-ROOD	4 pc. / 40 pc.	1"x4xEK14,16,18 & 20

**Type: VBS05**



**Manifold 3/4" with valves and eurocone connection**  
**Verdeler 3/4" met kraan en euroconus-aansluiting**  
**Collecteur 3/4" avec vanne et eurocone**  
**Verteiler 3/4" mit Kugelhahnset und Eurokonus**

Article number	Bag / Box	Type
VBS050502-BL	1 pc. / 20 pc.	3/4"x2xEK14,16,18 & 20
VBS050502-RO	1 pc. / 20 pc.	3/4"x2xEK14,16,18 & 20
VBS050503-BL	1 pc. / 15 pc.	3/4"x3xEK14,16,18 & 20
VBS050503-RO	1 pc. / 15 pc.	3/4"x3xEK14,16,18 & 20
VBS050504-BL	1 pc. / 10 pc.	3/4"x4xEK14,16,18 & 20
VBS050504-RO	1 pc. / 10 pc.	3/4"x4xEK14,16,18 & 20

**Type: VBS06**



**Manifold 1" with valves and eurocone connection**  
**Verdeler 1" met kraan en euroconus-aansluiting**  
**Collecteur 1" avec vanne et eurocone**  
**Verteiler 1" mit Kugelhahnset und Eurokonus**

Article number	Bag / Box	Type
VBS060502-BL	1 pc. / 20 pc.	1"x2xEK14,16,18 & 20
VBS060502-RO	1 pc. / 20 pc.	1"x2xEK14,16,18 & 20
VBS060503-BL	1 pc. / 15 pc.	1"x3xEK14,16,18 & 20
VBS060503-RO	1 pc. / 15 pc.	1"x3xEK14,16,18 & 20
VBS060504-BL	1 pc. / 10 pc.	1"x4xEK14,16,18 & 20
VBS060504-RO	1 pc. / 10 pc.	1"x4xEK14,16,18 & 20



## B. BRASS

### 1 Type: VBS



Plug M with O-ring VBS Manifold  
Blindstop M met O-ring VBS verdeler  
Bouchon M pour VBS collecteur avec O-ring  
Stopf M für Verteiler VBS mit O-Ring

Article number	Bag / Box	Type	
VBS-05	10 pc. / 250 pc.	3/4"	male
VBS-06	10 pc. / 250 pc.	1"	male

### 6 Type: VBS-F



Manifold plug F for VBS manifold  
Blindstop F voor VBS verdeler  
Bouchon F pour VBS collecteur  
Stopf F für Verteiler VBS

Article number	Bag / Box	Type	
VBS-05F	10 pc. / 250 pc.	3/4"	female
VBS-06F	10 pc. / 250 pc.	1"	female

### 12 Type: 17VBS



Straight adapter VBS manifold  
Recht aansluitstuk VBS verdeler  
Raccord droit VBS collecteur  
Gerades Verbindungsstück AG VBS Verteiler

Article number	Bag / Box	Type
17VBS-2005	10 pc. / 150 pc.	20mmx3/4"
17VBS-2605	5 pc. / 80 pc.	26mmx3/4"
17VBS-2606	5 pc. / 80 pc.	26mmx1"

### Type: 6VBS



Bend 90° VBS manifold  
Bocht 90° VBS verdeler  
Coude 90° VBS collecteur  
Winkel 90° VBS Verteiler

Article number	Bag / Box	Type
6VBS-2005	10 pc. / 50 pc.	20mmx3/4"
6VBS-2605	5 pc. / 50 pc.	26mmx3/4"

### Type: SK-B05



Bracket for Full Flow Manifold and VBS manifolds  
Montagebeugel voor Full Flow Manifold en VBS verdeler  
Double support pour collecteurs Full Flow Manifold et VBS  
Halter für Full Flow Manifold und VBS Verteiler

Article number	Bag / Box	Typ
SK-B05	1 pc. / 200 pc.	B05









1

### Type: RAD04-100V

2

3

4

5

6

7

### Type: EK15

8

9

10

11

12



Radiator connector with 3/4" eurocone connections, straight  
 Onderblok met 3/4" euroconus-aansluitingen, recht  
 Raccord radiateur, droit, eurocone  
 Heizkörperanschluss 1/2" mit 3/4" Eurokonus-Anschlüssen, unten

Article number	Box / Big Box	Type
RAD04-100V	10 pc. / 100 pc.	1/2"x3/4" EK

TILL EXHAUSTION OF STOCK



Eurocone (3/4"F) for copper tube 15mm  
 Euroconus-schroefkoppeling (3/4"F) voor koperbuis 15mm  
 Raccord à visser eurocone (3/4"F) pour tube en cuivre 15mm  
 Schraubfitting Eurokonus (3/4") für Kupferrohr 15mm

Article number	Box / Big Box	Type
EK15	25 pc. / 400 pc.	Ø15

### Type: RADTH-VL



Thermostatic radiator valve head  
 Thermostatisch regелеlement met vaste vloeistofvoeler  
 Tête thermostatique à bulbe, équipée d'un réglage de température limite  
 Thermostatkopf mit festem Flüssigkeitsfühler

Article number	Box / Big Box	Type
RADTH-VL	10 pc. / 150 pc.	THERM

TILL EXHAUSTION OF STOCK



## Type: BAP-FFV (press x press)\*



Stainless steel Full Flow Valve - press x press connections  
 Full Flow Bolkraan van roestvrij staal met pers x pers aansluitingen  
 Full Flow Vanne en acier inoxydable - raccords presse x presse  
 Full Flow Kugelhahn aus Edelstahl - Press x Press-Verbindungen

Article number	Box / Big Box	Type
BAP-FFV1616	25 pc.	16 x 16
BAP-FFV2020	25 pc.	20 x 20
BAP-FFV2626	25 pc.	26 x 26
BAP-FFV3232	15 pc.	32 x 32

## Type: BAP-FFV (press x female thread)\*



Stainless steel Full Flow Valve - press x female thread connections  
 Full Flow Bolkraan van roestvrij staal met pers x binnendraad aansluitingen  
 Full Flow Vanne en acier inoxydable - raccords presse x filetage femelle  
 Full Flow Kugelhahn aus Edelstahl - Press x IG Verbindungen

Article number	Box / Big Box	Type
BAP-FFV1604	25 pc.	16 x 1/2"
BAP-FFV1805	25 pc.	18 x 3/4"
BAP-FFV2005	25 pc.	20 x 3/4"
BAP-FFV2605	25 pc.	26 x 3/4"
BAP-FFV2606	15 pc.	26 x 1"
BAP-FFV3207	15 pc.	32 x 1 1/4"

## Type: BAP-FFV (press x swivel)\*



Stainless steel Full Flow Valve - press x swivel connections  
 Full Flow Bolkraan van roestvrij staal met pers x wartel aansluitingen  
 Full Flow Vanne en acier inoxydable - raccords presse x ecrou  
 Full Flow Kugelhahn aus Edelstahl - Press x Anschlussverschraubung Verbindungen

Article number	Box / Big Box	Type
BAP-FFV16Z05	25 pc.	16 x 3/4"
BAP-FFV20Z05	25 pc.	20 x 3/4"
BAP-FFV26Z05	25 pc.	26 x 3/4"
BAP-FFV26Z06	15 pc.	26 x 1"
BAP-FFV32Z06	15 pc.	32 x 1"

## Type: BAP-FFV (press x eurocone)\*



Stainless steel Full Flow Valve - press x eurocone connections  
 Full Flow Bolkraan van roestvrij staal met pers x euroconus aansluitingen  
 Full Flow Vanne en acier inoxydable - raccords presse x eurocone  
 Full Flow Kugelhahn aus Edelstahl - Press x Eurokonus Verbindungen

Article number	Box / Big Box	Type
BAP-FFV1605EK	25 pc.	16 x 3/4"
BAP-FFV2005EK	25 pc.	20 x 3/4"
BAP-FFV2605EK	15 pc.	26 x 3/4"



1 **Type: RADNI**



Nipple for H radiator block  
Nippel voor H-radiatorblok  
Vanne pour raccord radiateur (H&V)  
Nippel für H-Anschluss

Article number	Bag / Box	Type
RADNI-0504	10 pc. / 500 pc.	1/2"x3/4"

2  
3  
4  
5  
6 **Type: BAP-H**



Ball valve with handle, 2 x pressfitting  
Kogelkraan met handvat, 2 x perskoppeling  
Vanne à bille  
Kugelhahnset mit Handgriff, 2 x Pressfitting

Article number	Box / Big Box	Type
BAP-H1616	8 pc. / 80 pc.	16x16
BAP-H2020	8 pc. / 80 pc.	20x20
BAP-H2626	8 pc. / 80 pc.	26x26
BAP-H3232	5 pc. / 25 pc.	32x32

7  
8  
9  
10  
11 **Type: BAP-SV**



Stopvalve DN10  
Stopbolkraan / Ballofix DN10  
Vanne d'arrêt DN10  
Stopvalve DN10

Article number	Box / Big Box	Type
BAP-SV1610S	10 pc. / 100 pc.	16 x 10



**Type: 41S**



**Brass Vision coupling with valve F-connection**  
**Messing Vision koppeling met F-aansluiting**  
**Connecteur Vision F**  
**Vision Fitting mit F-Verbindung**

Article number	Bag / Box	Typ
41S-20	10 pc. / 60 pc.	20
41S-26	10 pc. / 80 pc.	26

**Type: 41SKS**



**Connection Vision coupling with valve F-connection**  
**Aansluitstuk Vision koppeling met F-aansluiting**  
**Raccord Vision Connecteur Vision F**  
**Messing Übergang Vision Fitting mit F-Verbindung**

Article number	Bag / Box	Typ
41SKS-20	10 pc. / 80 pc.	20
41SKS-26	10 pc. / 80 pc.	26

**Type: BA-F**



**Built in ball valve Fastec DN15**  
**Inbouwbolkraan Fastec DN15**  
**Vanne à sphere Fastec DN15**  
**Einbau Kugelhahnset Fastec DN15**

Article number	Box / Big Box	Type
BA-F41	1 pc. / 50 pc.	



- 1
- 2
- 3
- 4
- 5
- 6
- 7
- 8
- 9
- 10
- 11
- 12



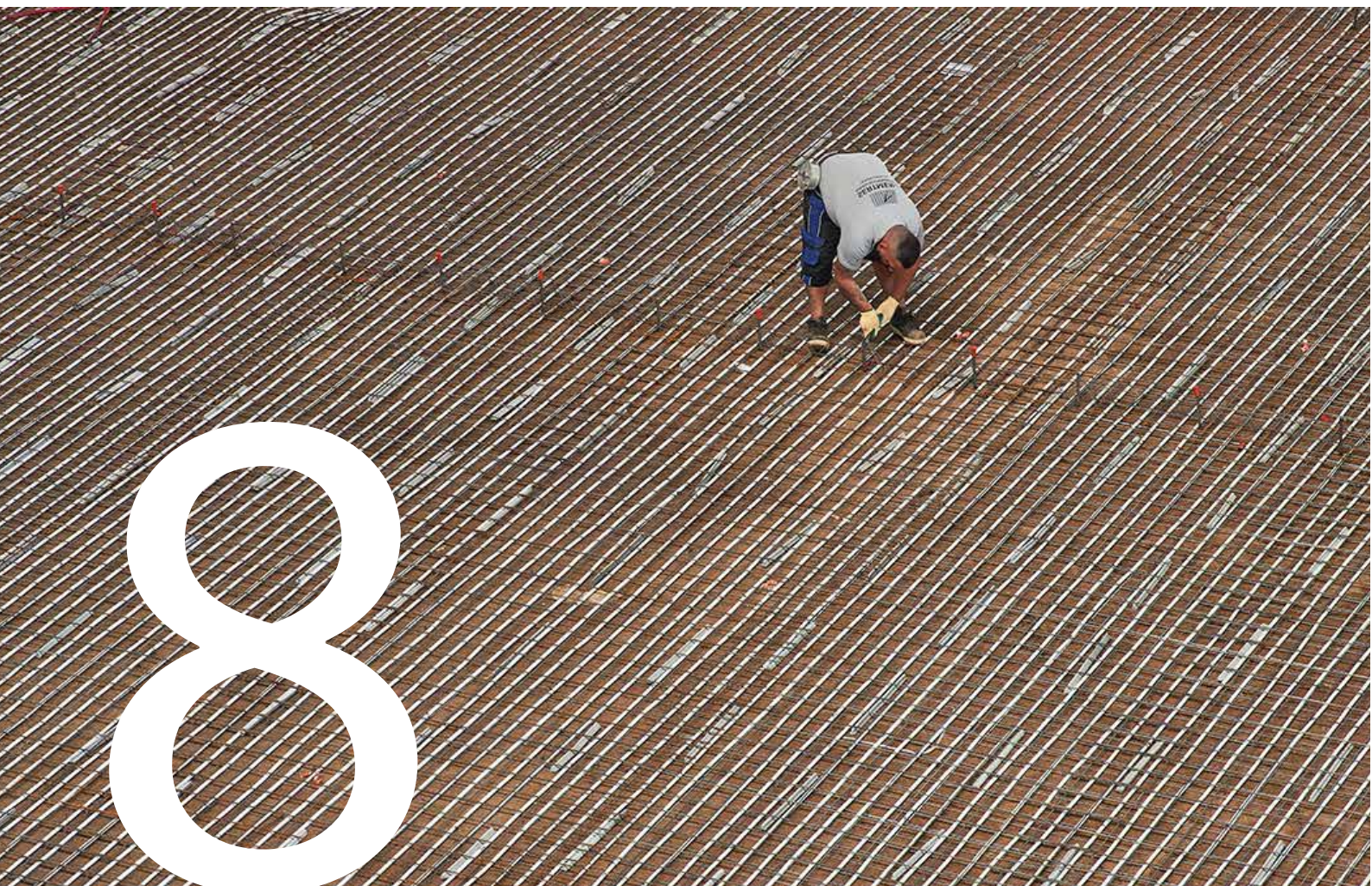

	<i>Page</i>
<b>A. SYSTEMS</b>	<b>111</b>
<b>B. MANIFOLDS</b>	<b>119</b>
<b>C. CONTROL UNITS</b>	<b>127</b>





## Type: UFH-ISOPRO30



System plate with 30 mm EPS insulation and 28dB acoustic improvement  
 Noppenplaat met 30 mm EPS isolatie, 28 dB geluidsverbetering  
 Plaque à plot avec isolation EPS de 30 mm, isolant acoustique 28dB  
 Systemplatte mit Dämmung Styropor 30 mm, Trittschallverbesserung 28dB

Article number	Packing	Type
UFH-ISOPRO30 *	6,72m <sup>2</sup> (6 x 1,12m <sup>2</sup> )	1400x800mm - 5kPa - 28dB

*\* Pipe Ø16, centre-to-centre: multiple 50mm hor./ver*

## Type: UFH-ISOPRO11



System plate with 11 mm EPS insulation  
 Noppenplaat met 11 mm EPS isolatie  
 Plaque à plot avec isolation EPS de 11 mm  
 Systemplatte mit Dämmung Styropor 11 mm

Article number	Packing	Type
UFH-ISOPRO11 *	14,56m <sup>2</sup> (13 x 1,12m <sup>2</sup> )	1400x800mm - 75kPa

*\* Pipe Ø16, centre-to-centre: multiple 50mm hor./ver.*

## Type: UFH-PRO



System plate without insulation  
 Noppenplaat zonder isolatie  
 Plaque à plot sans isolation  
 Systemplatte ohne Dämmung

Article number	Packing	Type
UFH-PRO *	13,44m <sup>2</sup> (12 x 1,12m <sup>2</sup> )	1400x800mm - 5kPa

*\* Pipe Ø16, centre-to-centre: multiple 50mm hor./ver.*

## Type: UFH-RAS10

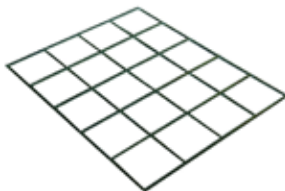

Galvanized steel mesh, 100 x 100 mm, 3 mm  
 Stalen draadmat verzinkt, 100 x 100 mm, 3 mm  
 Treillis en acier galvanisé, trame de 100 x 100 mm, 3 mm  
 Trägermatte aus Eisen verzinkt, Masche 100 x 100 mm, 3 mm

Article number	Packing	Type
UFH-RAS10	10 pc.	2,52 m <sup>2</sup> - grid 100x100mm

## Type: UFH-RAS15

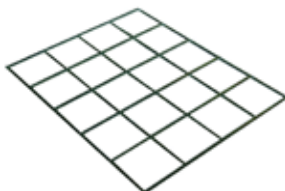

Galvanized steel mesh, 150 x 150 mm, 3 mm  
 Stalen draadmat verzinkt, 150 x 150 mm, 3 mm  
 Treillis en acier galvanisé, trame de 150 x 150 mm, 3 mm  
 Trägermatte aus Eisen verzinkt, Masche 150 x 150 mm, 3 mm

Article number	Packing	Type
UFH-RAS15	10 pc.	2,52 m <sup>2</sup> - grid 150x150mm

## Type: UFH-RAS20

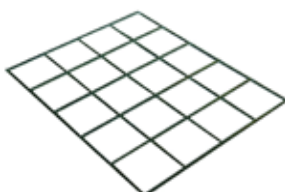

Galvanized steel mesh, 200 x 200 mm, 3 mm  
 Stalen draadmat verzinkt, 200 x 200 mm, 3 mm  
 Treillis en acier galvanisé, trame de 200 x 200 mm, 3 mm  
 Trägermatte aus Eisen verzinkt, Masche 200 x 200 mm, 3 mm

Article number	Packing	Type
UFH-RAS20	10 pc.	2,4 m <sup>2</sup> - grid 200x200mm



## A. SYSTEMS

### Type: UFH-RAS-RB3

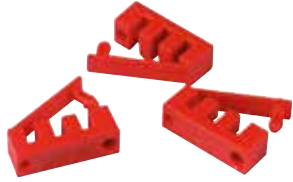

Connection clip for steel mesh  
Verbindingsclip voor stalen draadmatten  
Clip de fixation pour treillis  
Verbinder für Trägermatte

Article number	Packing	Type
UFH-RAS-RB3	30 pc.	RB

### Type: UFH-RAS-BIND15



UFH-RAS-VLE p 156

Steel strand, plasticized, to connect pipe on steel mesh  
Stalen vlechtdraad, geplastificeerd, om buis op draadmat te binden  
Fil de tressage métallique, plastifié, pour fixer tube sur treillis  
Stahldraht, plastifiziert, für Befestigung der Rohre auf Trägermatte

Article number	Packing	Type
UFH-RAS-BIND15A	250 pc.	160 mm
UFH-RAS-BIND15B	2500 pc.	160 mm

### Type: UFH-RAS-CLIP



Synthetic clip for steel mesh  
Kunststofclip voor draadmat  
Attache en plastique pour treillis  
Rohrclip für Trägermatte

Article number	Packing	Type
UFH-RAS-CLIP16	200 pc.	Ø16
UFH-RAS-CLIP18	200 pc.	Ø18
UFH-RAS-CLIP20	200 pc.	Ø20

### Type: UFH-TACK-KLS

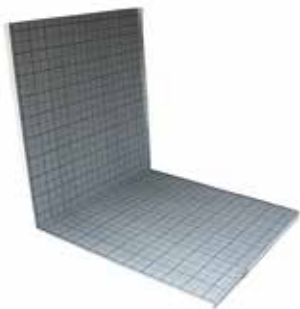

Tacker sheet with EPS insulation, foil with 100 x 100 mm grid marking and overlap  
Tacker klappset met EPS isolatie voorzien van folie met raster 100 x 100 mm en overlap  
Plaqué tacker en isolation EPS, film avec trame 100 x 100 mm et rabat  
Verbundplatte aus Styropordämmung mit Folie Masche 100 x 100 mm und Überschneidung

Article number	Packing	Type
UFH-TACK-KLS20	10 m <sup>2</sup> (5 x 2 m <sup>2</sup> )	1000x2000x20mm - 4kPa - 28dB
UFH-TACK-KLS25	10 m <sup>2</sup> (5 x 2 m <sup>2</sup> )	1000x2000x25mm - 4kPa - 28dB
UFH-TACK-KLS30	10 m <sup>2</sup> (5 x 2 m <sup>2</sup> )	1000x2000x30mm - 4kPa - 29dB

### Type: UFH-TACK-38K



UFH-TACK p 156

Tacker clip, 38 mm  
Tackernagel, 38 mm  
Agrafe tacker, 38 mm  
Tackernadel, 38 mm

Article number	Box / Big Box	Type
UFH-TACK-38K *	300 pc. / 6000 pc.	38 mm

\* Pipe Ø 16



## Type: UFH-TACK-40



UFH-TACK p 156

Tacker clip, 40 mm  
Tackernagel, 40 mm  
Agrafe tacker, 40 mm  
Tackernadel, 40 mm

Article number	Box / Big Box	Type
UFH-TACK-40 *	300 pc. / 8.400 pc.	40 mm

\* Pipe Ø 16-20

## Type: UFH-TACK-60



UFH-TACK p 156

Tacker clip, 60 mm  
Tackernagel, 60 mm  
Agrafe tacker, 60 mm  
Tackernadel, 60 mm

Article number	Box / Big Box	Type
UFH-TACK-60 *	300 pc. / 6.000 pc.	60 mm

\* Pipe Ø 16-20

## Type: UFH-SCOTCH-66



Adhesive tape  
Kleefband  
Ruban adhésif  
Klebeband

Article number	Packing	Type
UFH-SCOTCH-66	1 pc.	66 m

## Type: UFH-SECOR



Secor EPS panel with milling and alu foil  
Secor EPS paneel met frezing en aluminium top laag  
Panneau Secor en insulation PE avec fraisage et film en alu  
Secor platte aus Styropordämmung mit Fräsung und ALU folie

Article number	Packing	Type
UFH-DRY-1617-150F	8,80 m <sup>2</sup>	1175 x 750 x 17 - 150mm
UFH-DRY-1617-200F	9,00 m <sup>2</sup>	1175 x 800 x 17 - 200mm
UFH-DRY-1625-100F	9,40 m <sup>2</sup>	1175 x 800 x 25 - 100mm
UFH-DRY-1625-150F	8,80 m <sup>2</sup>	1175 x 750 x 25 - 150mm
UFH-DRY-1625-200F	9,00 m <sup>2</sup>	1175 x 800 x 25 - 200mm
UFH-DRY-1630-150F	9,40 m <sup>2</sup>	1175 x 750 x 30 - 150mm

## Type: UFH-DRY-TAPE



Alu tape  
Alu kleefband  
Bande adhésive aluminium  
ALU Klebeband

Article number	Packing	Type
UFH-DRY-FTAPE	1 pc.	25000 x 50mm



## A. SYSTEMS

### Type: UFH-DRY-GLUEF



Secor glue  
Secor lijm  
Colle secor  
Secor Klebstoff

Article number	Packing	Type
UFH-DRY-GLUEF	1 kg	

### Type: UFH-P18-GP18



Gypsum fibreboard 18mm, round milling for RENO12 system  
Gipsvezelplaat 18mm, ronde frezing voor RENO12 systeem  
Plaques en fibro-plâtre 18mm, avec une fraisage circulaire système RENO12  
Gipsfaserplatte 18mm, runde Fräsung für das RENO12 system

Article number	pc	Type
UFH-P18-GP18	1 pc.	1000 x 600 x 18mm

### Type: UFH-P18-GP18V



Gypsum fibreboard 18mm, vertical milling for RENO12 system  
Gipsvezelplaat 18mm, verticale frezing voor RENO12 systeem  
Plaques en fibro-plâtre 18mm, système RENO12  
Gipsfaserplatte 18mm, vertikale Fräsung für das RENO12 system

Article number	pc	Type
UFH-P18-GP18V	1 pc.	1000 x 600 x 18mm

### Type: UFH-P18-GP10

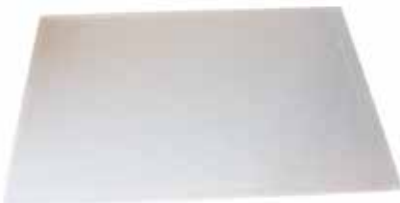

Gypsum fibreboard 10mm, flat for RENO12 system  
Gipsvezelplaat 10mm, vlak voor RENO12 systeem  
Plaques en fibro-plâtre 10mm, système RENO12  
Gipsfaserplatte 10mm, flach für das RENO12 system

Article number	pc	Type
UFH-P18-GP10	1 pc.	1500 x 1000 x 10mm

TILL EXHAUSTION OF STOCK

### Type: UFH-P18-WN



Mesh for RENO12 system  
Wapeningsnet voor RENO12 systeem  
Treillis d'armature système RENO12  
Betonstahlmatte für das RENO12 system

Article number	Packing	Type
UFH-P18-WN	50 m <sup>2</sup>	1 x 50m

TILL EXHAUSTION OF STOCK



## Type: UFH-ISODRY-25



Insulation system board for dry system  
 Isolatieplaat voor droog systeem  
 Panneau d'isolation pour système sec  
 Systemplatte für Trockenbau

Article number	Packing	Type
UFH-ISODRY-25	10 m <sup>2</sup>	1000x500x25mm

## Type: UFH-DRY-GP100-2



Heat diffusion profile for dry system  
 Stralingsprofiel voor droog systeem  
 Profil de diffusion pour système sec  
 Wärmeleitlamelle für Trockenbau

Article number	Packing	Type
UFH-DRY-GP100-2	50 pc.	997x120x0,4mm - Ø16

## Type: UFH-DRY-VD100

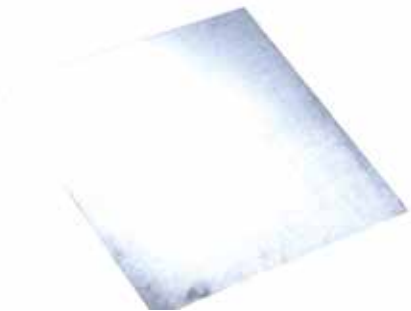

Heat diffusion board for dry system  
 Stralingsverdeelplaat voor droog systeem  
 Panneau de diffusion pour système sec  
 Verteilerbleche für Trockenbau

Article number	Packing	Type
UFH-DRY-VD100	1 pc.	1000x1000mm

## Type: UFH-DRY-B



Synthetic mounting bracket for pipe in diagonal position  
 kunststofbeugel voor bevestiging buis bij diagonaalverlegging  
 Fixation en plastique pour pose du tube diagonal  
 Kunststoffreiter für Diagonalverlegung

Article number	Packing	Type
UFH-DRY-B	100	

## Type: UFH-UP-M



Clip rail with adhesive strip, centres 50 mm  
 U-profiel met kleefband, verlegafstand 50 mm  
 Profil-U avec bande adhésif, distance de pose 50 mm  
 Kunststoffclip-Schiene klebfertig für Rohr, Verlegung 50 mm

Article number	Box / Pallet	Type
UFH-UP-14M1	100 m / 1000 m	Ø14 - AS 25 mm- 1000 mm
UFH-UP-16M1	100 m / 1000 m	Ø16 - AS 50 mm- 1000 mm

1

2

3

4

5

6

7

8

9

10

11

12





## A. SYSTEMS

### 1 Type: UFH-UP

2

3

4

5



Clip rail with adhesive strip, centres 50 mm  
 U-profiel met kleefband, verlegafstand 50 mm  
 Profil-U avec bande adhésif, distance de pose 50 mm  
 Kunststoffclip-Schiene klebfertig für Rohr, Verlegung 50 mm

Article number	Box / Pallet	Type
UFH-UP-12	32 m / 960 m	Ø12 - AS 25 mm- 2000 mm
UFH-UP-16	100 m / 3000 m	Ø16 - AS 50 mm- 2500 mm

### 6 Type: UFH-UP-CUP

7

8

9



Staple for clip rail  
 Clip voor U-profielen  
 Agrafe pour profil-U  
 Nadel für Schienen

Article number	Box / Big Box	Type
UFH-UP-CUP50	500 pc. / 9000 pc.	50 mm

### 10 Type: UFH-FOIL

11

12



PE film, transparant, with blue grid marking 50 x 50 mm  
 PE-folie, transparant, blauwe rastermarkering 50 x 50 mm  
 Film en PE, transparent avec marquage 50 x 50 mm en bleu  
 Polyethylen-Schutzfolie, transparent, Markierung Blau 50x50mm

Article number	Packing	Type
UFH-FOIL50	51 m <sup>2</sup>	34m x 1,5m - 0,14mm
UFH-FOIL90	90 m <sup>2</sup>	60m x 1,5m - 0,14mm

### Type: UFH-FOIL-N



PE film, neutral  
 PE-folie, neutraal  
 Film en PE, neutre  
 Polyethylen-Schutzfolie, neutral

Article number	Packing	Type
UFH-FOIL-N	100 m <sup>2</sup>	50 m x 2 m - 0,2 mm

### Type: UFH-FOIL-ALU



PE film, reflecting ALU  
 PE-folie, met PE-flap en ALU reflectie  
 Film en PE avec réflexion ALU  
 Polyethylen-Schutzfolie, Reflition ALU

Article number	Packing	Type
UFH-FOIL-ALU	50 m <sup>2</sup>	50 m x 1 m - 3,0 mm

### Type: UFH-FOIL-CLIP25



Clip for Film  
 Dampfolienagel  
 Agrafe pour film PE  
 Foliendübel

Article number	Packing	Type
UFH-FOIL-CLIP25	100 pc.	25 mm



## Type: UFH-PLUG80



Plug, shaft length 80 mm, Ø8 mm  
 Montageplug, schachtlengte 80 mm, Ø8 mm  
 Cheville de montage, longueur 80 mm, Ø8 mm  
 Niederhaltedübel, Bohrer Ø 8 mm, Schaftlänge 80 mm

Article number	Packing	Type
UFH-PLUG80	100 pc.	80 mm, Ø8 mm

## Type: UFH-ISOBOARD-S



PE edge isolation with lapping strip and adhesive strip  
 Randisolatie uit PE-schuim met PE-flap en kleefstroken  
 Isolation périphérique en PE avec rabat et bande adhésif  
 Randdämmstreifen aus PE mit Abrisskante und Klebestreifen

Article number	Packing	Type
UFH-ISOBOARD-S	25 m	150 x 8 mm

## Type: UFH-ISOBOARD-GVNL



PE edge isolation with lapping strip and adhesive strip for liquid floors  
 Randisolatie voor gietvloeren uit PE-schuim met flap en kleefstroken  
 Isolation périphérique en PE avec rabat et bande adhésif pour sols coulés  
 Randdämmstreifen aus PE mit Abrisskante und Klebestreifen für Gussböden

Article number	Packing	Type
UFH-ISOBOARD-GVNL	50m	100 mm x 8 mm

## Type: UFH-ISOBOARD-GV



PE edge isolation with lapping strip and adhesive strip for anhydrite screed  
 Randisolatie voor anhydriet chape uit PE-schuim met flap en kleefstroken  
 Isolation périphérique en PE avec rabat et bande adhésif, pour chape anhydrite  
 Randdämmstreifen aus PE mit Abrisskante und Klebestreifen, für Anhydritestrich

Article number	Packing	Type
UFH-ISOBOARD-GV	25 m	150 mm x 8 mm



## A. SYSTEMS

1

### Type: UFH-DP200

2

3

4

5

6



PE expansion joint with self-adhesive rail  
 Uitzettingsvoeg uit PE-schuim met zelfklevende rail  
 Joint de dilatation en PE avec bande adhésive  
 Dehnungsfuge aus PE mit Klebestreifen

Article number	Packing	Type
UFH-DP200	2 m	2000 mm x 100 mm x 8 mm

7

### Type: UFH-DH40

8

9

10

11

12



Protection sleeve for expansion joint  
 Voegdoorganghuls  
 Gaine de protection pour joint de dilatation  
 Schutzrohre für Dehnungsfugen

Article number	Packing	Type
UFH-DH40	100 pc.	400 mm

### Type: UFH-BEND



Bend guide for pipe  
 Geleidingsbocht voor buis  
 Courbe pour tube  
 Rohrführungsbogen

Article number	Packing	Type
UFH-BEND1218	1 pc.	Ø 12 - 18 mm
UFH-BEND20	1 pc.	Ø 20 mm

### Type: UFH-ADN10



Additive for screed (min. pipe covering 45 mm)  
 Toevoegmiddel voor zandcementvloer (min. Buisoverdekking 45 mm)  
 Additif pour chape de ciment (min. épaisseur de chape au-dessus du tube 45 mm)  
 Estrichzusatz (min. Rohrüberdeckung 45 mm)

Article number	Packing	Type
UFH-ADN10	10 L	



### Type: UFH-MDK



Manifold composite, adjustable with flow meter, thermometer washer and air vent  
 Composiet verdeler, regelbaar met debietmeting, thermometer, vul- en aftapkraan, ontluchter

Collecteur composite, réglable avec débitmètre, thermomètre, vanne d'apport et purgeur d'air

Verteiler Composite, regelbar mit Durchflussmengenmesser, Thermomesser, Entleerung und Entlüfter

Article number	Packing	Type
UFH-0605MDK02-03L	1 pc.	1" - 2 x 3/4"
UFH-0605MDK03-03L	1 pc.	1" - 3 x 3/4"
UFH-0605MDK04-03L	1 pc.	1" - 4 x 3/4"
UFH-0605MDK05-03L	1 pc.	1" - 5 x 3/4"
UFH-0605MDK06-03L	1 pc.	1" - 6 x 3/4"
UFH-0605MDK07-03L	1 pc.	1" - 7 x 3/4"
UFH-0605MDK08-03L	1 pc.	1" - 8 x 3/4"
UFH-0605MDK09-03L	1 pc.	1" - 9 x 3/4"
UFH-0605MDK10-03L	1 pc.	1" - 10 x 3/4"
UFH-0605MDK11-03L	1 pc.	1" - 11 x 3/4"
UFH-0605MDK12-03L	1 pc.	1" - 12 x 3/4"

### Type: UFH-MDK-CON



Composite connector for MDK manifold

Composiet verbinder voor MDK verdeler

Connecteur en composite pour collecteur MDK

Composiet Verbinder für MDK Verteiler

Article number	Bag / Box	Type
UFH-MDK-CON	1 pc. / 50 pc.	

### Type: UFH-CMDK



Flow meter for MDK manifold

Debietmeter voor MDK verdeler

Débitmètre pour collecteur MDK

Durchflussmengenanzeiger für MDK Verteiler

Article number	Packing	Type
UFH-CMDK03	1 pc.	0 - 5 l
UFH-CMDK10	1 pc.	0 - 2,5 l

### Type: UFH-MDK-AO



Automatic air vent in composite for MDK manifold

Composiet automatische ontluchter voor MDK verdeler

Purgeur automatique en composite pour collecteur MDK

Automatische entlüftung in composiet für MDK verteiler

Article number	Packing	Type
UFH-MDK-AO	1 pc.	3/8"



## B. MANIFOLDS

### 1 Type: UFH-MDSS



Stainless steel manifold  
Roestvrij stalen verdeler  
Distributeur en acier inoxydable  
Edelstahlverteiler

Article number	Packing	Type
UFH-0605MDSS02	1 pc.	1" - 2 x 3/4"
UFH-0605MDSS03	1 pc.	1" - 3 x 3/4"
UFH-0605MDSS04	1 pc.	1" - 4 x 3/4"
UFH-0605MDSS05	1 pc.	1" - 5 x 3/4"
UFH-0605MDSS06	1 pc.	1" - 6 x 3/4"
UFH-0605MDSS07	1 pc.	1" - 7 x 3/4"
UFH-0605MDSS08	1 pc.	1" - 8 x 3/4"
UFH-0605MDSS09	1 pc.	1" - 9 x 3/4"
UFH-0605MDSS10	1 pc.	1" - 10 x 3/4"
UFH-0605MDSS11	1 pc.	1" - 11 x 3/4"
UFH-0605MDSS12	1 pc.	1" - 12 x 3/4"
UFH-0605MDSS13	1 pc.	1" - 13 x 3/4"
UFH-0605MDSS14	1 pc.	1" - 14 x 3/4"
UFH-0605MDSS15	1 pc.	1" - 15 x 3/4"

### 8 Type: UFH-CMDSS



Flow meter for MDSS manifold  
Debietmeter voor MDSS verdeler  
Débitmètre pour collecteur MDSS  
Durchflussmengenanzeiger für MDSS Verteiler

Article number	Packing	Type
UFH-CMDSS	1 pc.	0 - 5 l





### Type: UFH-06-MD



Manifold brass, adjustable, with flow meters  
 Verdeler messing, regelbaar, met debietmeting  
 Collecteur en laiton, réglable, avec débitmètres  
 Verteiler aus Messing, regelbar, mit Durchflussmengenmesser

Article number	Packing	Type
UFH-060502-MD	1 pc.	1" M - 2 x 3/4"
UFH-060503-MD	1 pc.	1" M - 3 x 3/4"
UFH-060504-MD	1 pc.	1" M - 4 x 3/4"
UFH-060505-MD	1 pc.	1" M - 5 x 3/4"
UFH-060506-MD	1 pc.	1" M - 6 x 3/4"
UFH-060507-MD	1 pc.	1" M - 7 x 3/4"
UFH-060508-MD	1 pc.	1" M - 8 x 3/4"
UFH-060509-MD	1 pc.	1" M - 9 x 3/4"
UFH-060510-MD	1 pc.	1" M - 10 x 3/4"
UFH-060511-MD	1 pc.	1" M - 11 x 3/4"
UFH-060512-MD	1 pc.	1" M - 12 x 3/4"

### Type: UFH-M-D



Flow meter for brass manifold  
 Debietmeter voor messing verdeler  
 Débitmètre pour collecteur en laiton  
 Durchflussmengenanzeiger für Verteiler aus Messing

Article number	Packing	Type
UFH-M-D	1 pc.	

### Type: UFH-PGKTA



Pump unit A label pump with consistent temperature control  
 Pompgroep A-label met regeling voor constante temperatuur  
 Kit pompe label A avec régulation de température constante  
 Konstanttemperaturregelung mit A-Pumpe

Article number	Packing	Type
UFH-PGKTA	1 pc.	1" F / 27°C - 42°C

### Type: UFH-PGKTA-TH



Thermostatic sensor UFH-PGKTA  
 Thermostaat kop voor UFH-PGKTA  
 Tête thermostatique UFH-PGKTA  
 Thermostatkopf UFH-PGKTA

Article number	Packing	Type
UFH-PGKTA-TH	1 pc.	

### Type: UFH-GKT



Unit with consistent temperature control without pump  
 Groep met regeling voor constante temperatuur zonder pomp  
 Kit avec régulation de température constante sans pompe  
 Konstanttemperaturregelung ohne Pump

Article number	Packing	Type
UFH-GKT	1 pc.	1" F / 27°C - 42°C



## B. MANIFOLDS

1

### Type: UFH-BT-M

2

3

4

5



1" F ball valve with 1" F swivel nut, washer and thermometer  
 Kogelkraan 1" F met wartelmoer 1" F , dichting en thermometer  
 Vanne à sphère 1" F avec écrou 1" F, joint et thermomètre  
 Kugelhahnset 1" IG mit Mutter 1" IG , Dichtung und Thermometer

Article number	Packing	Type
UFH-BTM0606-M	1 set (2 pc.)	1" F x 1" F / 0 - 60 °

6

### Type: UFH-B-M

7

8

9

10



1" F ball valve with 1" F swivel nut and washer  
 Kogelkraan 1" F met wartelmoer 1" F en dichting  
 Vanne à sphère 1" F avec écrou 1" F et joint plat  
 Kugelhahnset 1" IG mit Mutter 1" IG und Dichtung

Article number	Packing	Type
UFH-B0606-M	1 set (2 pc.)	1" F x 1" F

11

### Type: UFH-ESK-M

12



1" F end cap with nut, washer, ball valve and air vent 3/8"  
 Eindstuk 1" F met moer, dichting, kogelkraan en ontluftingskraan 3/8"  
 Bouchon terminal 1" F avec écrou, vanne à sphère, joint et purgeur 3/8"  
 Verteilerendstückset 1" IG mit Mutter und Dichtung, Entlüftung 3/8", Kugelhahnset

Article number	Packing	Type
UFH-ESK060303-M	1 set (2 pc.)	1" F x 1/2" x 3/8"

### Type: UFH-ESK-VN



1" F end cap with nut, washer, ball valve and air vent 3/8", nickel-plated  
 Eindstuk 1" F met moer, dichting, kogelkraan en ontluftingskraan 3/8", vernikkeld  
 Bouchon terminal 1" F avec écrou, joint et purgeur 3/8", nickelé  
 Verteilerendstückset 1" IG mit Mutter und Dichtung, Entlüftung 3/8", Kugelhahnset, vernikkelt

Article number	Packing	Type
UFH-ESK060303-VN	1 set (2 pc.)	1" F x 1/2" x 3/8"

### Type: UFH-AO-MZ



Automatic air vent, without check valve  
 Automatische ontlufter, zonder waterslot  
 Purgeur automatique, sans serrure d'eau  
 Schnellentlüfter mit vertikaler Entlüftung, ohne Wasserabsperrung

Article number	Packing	Type
UFH-AO03-MZ	1 pc.	3/8"

### Type: UFH-TM-M



Thermometer for return with EK connections  
 Thermometer voor terugvoer met euroconus aansluitingen  
 Retour thermomètre avec raccordement eurocone  
 Thermometer zum Anschluss Rücklauf mit Eurokonus-Anschlüssen

Article number	Packing	Type
UFH-TM050-M	1 pc.	3/4" - 3/4" EK / 0



### Type: UFH-BS-M



End cap with washer  
Blindstop  
Bouchon  
Kappe mit Dichtung

Article number	Packing	Type
UFH-BS05-M	1 pc.	3/4"

### Type: UFH-C260003001



Thermostatic temperature limiter  
Thermostatische temperatuurbegrenzer  
Limiteur de température thermostatique  
Thermostatischer Temperaturbegrenzer

Article number	Packing	Type
UFH-C260003001	1 pc.	3/4"

### Type: UFH-B-VN



1" F ball valve with 1" F swivel nut and washer , nickel-plated  
Kogelkraan 1" F met wartelmoer 1" F en dichtung, vernikkeld  
Vanne à sphère 1" F avec écrou 1" F et joint, nickelé  
Kugelhahnset 1" IG mit Mutter 1" IG und Dichtung, vernickelt

Article number	Packing	Type
UFH-B0606-VN	1 set (2 pc.)	1" F x 1" F / 0 - 60 °

*TILL EXHAUSTION OF STOCK*

### Type: UFH-BMH-VN



Ball valve 90° with gasket, nickel plated (MDK and MDSS manifold), no thermometer  
Kogelkraan 90° met dichtung, vernikkeld (MDK en MDSS verdeler), geen thermometer  
Vanne à sphère 90° et joint, nickelé (collecteur MDK et MDSS), sans thermomètre  
Kugelhahnset 90°, vernickelt (Verteiler MDK und MDSS), ohne thermomètre

Article number	Packing	Type
UFH-BMH0606-VN	1 set (2 pc.)	1" x 1"

### Type: UFH-BMHT-VN



Ball valve 90° with gasket, nickel plated (MDK and MDSS manifold), thermometer  
Kogelkraan 90° met dichtung, vernikkeld (MDK en MDSS verdeler), met thermometer  
Vanne à sphère 90° et joint, nickelé (collecteur MDK et MDSS), avec thermomètre  
Kugelhahnset 90°, vernickelt (für Verteiler MDK und MDSS), mit thermomètre

Article number	Packing	Type
UFH-BMH0606T-VN	1 set (2 pc.)	1" x 1"

### Type: UFH-BM-VN



Ball valve with gasket, nickel plated (for MDK and MDSS manifold)  
Kogelkraan met dichtung, vernikkeld (voor MDK en MDSS verdeler)  
Vanne à sphère et joint, nickelé (pour collecteur MDK et MDSS)  
Kugelhahnset, vernickelt (für Verteiler MDK und MDSS)

Article number	Packing	Type
UFH-B0605-VN*	1 set (2 pc.)	3/4" x 1"
UFH-BM0606-VN	1 set (2 pc.)	1" x 1"

*\*TILL EXHAUSTION OF STOCK*

## B. MANIFOLDS

### Type: UFH-CDP



Also available with Active Flow Control  
Including cord, plug and maximum thermostat

Manifold composite, adjustable with flow meter and A-pump  
Composiet verdeler, regelbaar met debietmeting en A-pomp  
Collecteur composite, réglable avec débitmètre et pompe label A  
Verteiler Composite, regelbar mit Durchflussmengenmesser und A-Pumpe

Article number	Packing	Type
UFH-0405CDP01	1 pc.	1/2" - 1 x 3/4"
UFH-0405CDP02	1 pc.	1/2" - 2 x 3/4"
UFH-0405CDP03	1 pc.	1/2" - 3 x 3/4"
UFH-0405CDP04	1 pc.	1/2" - 4 x 3/4"
UFH-0405CDP05	1 pc.	1/2" - 5 x 3/4"
UFH-0405CDP06	1 pc.	1/2" - 6 x 3/4"
UFH-0505CDP07	1 pc.	3/4" - 7 x 3/4"
UFH-0505CDP08	1 pc.	3/4" - 8 x 3/4"
UFH-0505CDP09	1 pc.	3/4" - 9 x 3/4"
UFH-0505CDP10	1 pc.	3/4" - 10 x 3/4"
UFH-0505CDP11	1 pc.	3/4" - 11 x 3/4"
UFH-0505CDP12	1 pc.	3/4" - 12 x 3/4"
UFH-0505CDP13	1 pc.	3/4" - 13 x 3/4"
UFH-0505CDP14	1 pc.	3/4" - 14 x 3/4"
UFH-0505CDP15	1 pc.	3/4" - 15 x 3/4"
UFH-0505CDP16	1 pc.	3/4" - 16 x 3/4"

### Type: UFH-CD

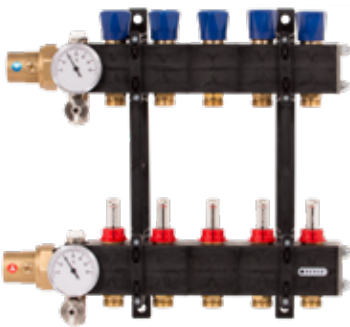

Also available with Active Flow Control

Manifold composite, adjustable with flow meter  
Composiet verdeler, regelbaar met debietmeting  
Collecteur composite, réglable avec débitmètre  
Verteiler Composite, regelbar mit Durchflussmengenmesser

Article number	Packing	Type
UFH-0605CD01	1 pc.	1" - 1 x 3/4"
UFH-0605CD02	1 pc.	1" - 2 x 3/4"
UFH-0605CD03	1 pc.	1" - 3 x 3/4"
UFH-0605CD04	1 pc.	1" - 4 x 3/4"
UFH-0605CD05	1 pc.	1" - 5 x 3/4"
UFH-0605CD06	1 pc.	1" - 6 x 3/4"
UFH-0605CD07	1 pc.	1" - 7 x 3/4"
UFH-0605CD08	1 pc.	1" - 8 x 3/4"
UFH-0605CD09	1 pc.	1" - 9 x 3/4"
UFH-0605CD10	1 pc.	1" - 10 x 3/4"
UFH-0605CD11	1 pc.	1" - 11 x 3/4"
UFH-0605CD12	1 pc.	1" - 12 x 3/4"
UFH-0605CD13	1 pc.	1" - 13 x 3/4"
UFH-0605CD14	1 pc.	1" - 14 x 3/4"
UFH-0605CD15	1 pc.	1" - 15 x 3/4"
UFH-0605CD16	1 pc.	1" - 16 x 3/4"
UFH-0605CD17	1 pc.	1" - 17 x 3/4"
UFH-0605CD18	1 pc.	1" - 18 x 3/4"
UFH-0605CD19	1 pc.	1" - 19 x 3/4"
UFH-0605CD20	1 pc.	1" - 20 x 3/4"

### Type: UFH-CP



A-pump unit for composite collector  
Pompunit composiet verdeler, met A-pomp  
Kit pompe-A pour collecteur composite  
A-Pump Unit für Composite Verteiler

Article number	Packing	Type
UFH-CP	1 pc.	1"



### Type: UFH-SLT



Including cord, plug and maximum thermostat

Steel collector with A-pump  
Stalen verdeler met A-pomp  
Collecteur en acier avec pompe label A  
Verteiler Stahl mit A-Pump

Article number	Packing	Type
UFH-0405SLT01	1 pc.	1/2" - 1 x 3/4"
UFH-0405SLT02	1 pc.	1/2" - 2 x 3/4"
UFH-0405SLT03	1 pc.	1/2" - 3 x 3/4"
UFH-0405SLT04	1 pc.	1/2" - 4 x 3/4"
UFH-0405SLT05	1 pc.	1/2" - 5 x 3/4"
UFH-0405SLT06	1 pc.	1/2" - 6 x 3/4"
UFH-0405SLT07	1 pc.	3/4" - 7 x 3/4"
UFH-0405SLT08	1 pc.	3/4" - 8 x 3/4"
UFH-0405SLT09	1 pc.	3/4" - 9 x 3/4"
UFH-0405SLT10	1 pc.	3/4" - 10 x 3/4"
UFH-0405SLT11	1 pc.	3/4" - 11 x 3/4"
UFH-0405SLT12	1 pc.	3/4" - 12 x 3/4"
UFH-0405SLT13	1 pc.	3/4" - 13 x 3/4"
UFH-0405SLT14	1 pc.	3/4" - 14 x 3/4"
UFH-0405SLT15	1 pc.	3/4" - 15 x 3/4"
UFH-0405SLT16	1 pc.	3/4" - 16 x 3/4"

### Type: UFH-SSTN-PN6



Including cord, plug and maximum thermostat

Steel collector with pump, district heating nuon and eneco  
Stalen verdeler met pomp, stadsverwarming nuon en eneco  
Collecteur en acier avec pompe, chauffage urbain nuon et eneco  
Verteiler Stahl mit Pump, Fernheizung nuon und eneco

Article number	Packing	Type
UFH-0405SSTN01-PN6	1 pc.	1/2" - 1 x 3/4"
UFH-0405SSTN02-PN6	1 pc.	1/2" - 2 x 3/4"
UFH-0405SSTN03-PN6	1 pc.	1/2" - 3 x 3/4"
UFH-0405SSTN04-PN6	1 pc.	1/2" - 4 x 3/4"
UFH-0405SSTN05-PN6	1 pc.	1/2" - 5 x 3/4"
UFH-0405SSTN06-PN6	1 pc.	1/2" - 6 x 3/4"
UFH-0505SSTN07-PN6	1 pc.	3/4" - 7 x 3/4"
UFH-0505SSTN08-PN6	1 pc.	3/4" - 8 x 3/4"
UFH-0505SSTN09-PN6	1 pc.	3/4" - 9 x 3/4"
UFH-0505SSTN10-PN6	1 pc.	3/4" - 10 x 3/4"
UFH-0505SSTN11-PN6	1 pc.	3/4" - 11 x 3/4"
UFH-0505SSTN12-PN6	1 pc.	3/4" - 12 x 3/4"





## B. MANIFOLDS

### Type: UFH-SSTE-PN6



Including cord, plug and maximum thermostat

Steel collector with pump, district heating essent  
 Stalen verdeler met pomp, stadsverwarming essent  
 Collecteur en acier avec pompe, chauffage urbain essent  
 Verteiler Stahl mit Pump, Fernheizung essent

Article number	Packing	Type
UFH-0405SSTE01-PN6	1 pc.	1/2" - 1 x 3/4"
UFH-0405SSTE02-PN6	1 pc.	1/2" - 2 x 3/4"
UFH-0405SSTE03-PN6	1 pc.	1/2" - 3 x 3/4"
UFH-0405SSTE04-PN6	1 pc.	1/2" - 4 x 3/4"
UFH-0405SSTE06-PN6	1 pc.	1/2" - 6 x 3/4"
UFH-0505SSTE07-PN6	1 pc.	3/4" - 7 x 3/4"
UFH-0505SSTE08-PN6	1 pc.	3/4" - 8 x 3/4"
UFH-0505SSTE09-PN6	1 pc.	3/4" - 9 x 3/4"
UFH-0505SSTE10-PN6	1 pc.	3/4" - 10 x 3/4"
UFH-0505SSTE11-PN6	1 pc.	3/4" - 11 x 3/4"
UFH-0505SSTE12-PN6	1 pc.	3/4" - 12 x 3/4"

### Type: UFH-C192071



Safety thermostat incl. wire/plug  
 Maximaal thermostaat incl. snoer/stekker  
 Thermostat de sécurité incl. fil/prise  
 Maximal Thermostat incl. Snur/Stecker

Article number	Packing	Type
UFH-C192071	1 pc.	

### Type: UFH-C191800



Thermometer with immersion sleeve 0/60 gr.  
 Thermometer met dompelbuis temp 0/60 gr.  
 Thermomètre temp. 0/60 gr. avec bulbe  
 Thermometer mit Tauchhülse 0/60 gr.

Article number	Packing	Type
UFH-C191800	1 pc.	

### Type: UFH-C191974 - 76



Circulator Wilo Yonos Para RS 15/6-RKA KU 130mm (excl. wire/plug)  
 Circulator Wilo Yonos Para RS 15/6-RKA KU 130mm (excl. snoer/stekker)  
 Circulateur Wilo Yonos Para RS 15/6-RKA KU 130mm (excl. fil/prise)  
 Cirkulator Wilo Yonos Para RS 15/6-RKA KU 130mm (excl. Snur/Stecker)

Article number	Packing	Type
UFH-C191974		1"
UFH-C191976		1 1/2"



**WIRED CONTROL UNIT**  
**BEKABELDE ZONEREGELING**  
**RÉGULATEURS DE ZONE CÂBLÉS**  
**REGELVERTEILER VERDRAHTET**

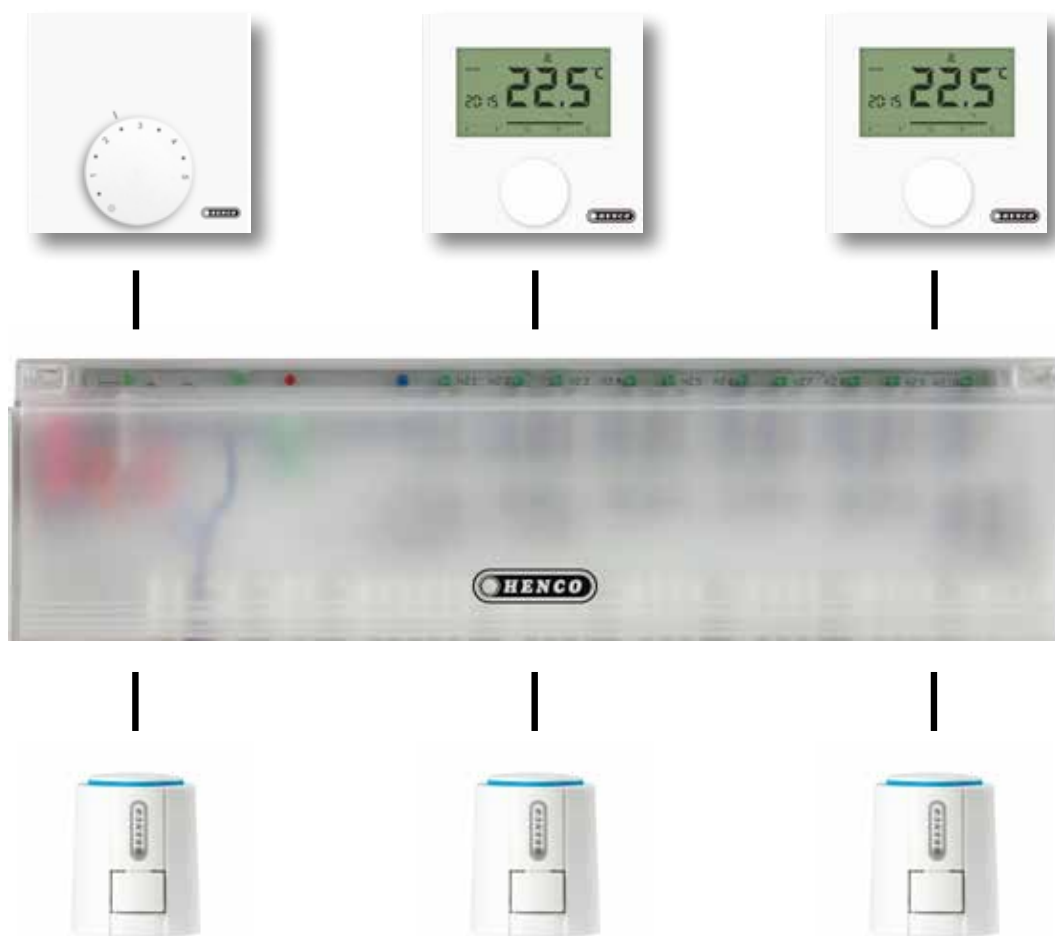

- 1
- 2
- 3
- 4
- 5
- 6
- 7
- 8**
- 9
- 10
- 11
- 12

## C. CONTROL UNITS

### Type: CU-6ZONE



Base module 6 zones, transformator incl.  
 Basisstation 6 zonen, transformator incl.  
 Base module 6 zones, transformator incl.  
 Regelklemmleiste 6-Zonen, Basic, inkl. Transformator

Article number	Packing	Type
CU-6ZONE-24V	1 pc.	24V
CU-6ZONE-230V	1 pc.	230V

### Type: CU-6ZONEP



Base module Plus 6 zones, transformator incl. (heating/cooling with pump contact)  
 Basisstation Plus 6 zonen, transformator incl. (verwarmen/koelen met pompsturing)  
 Base module Plus 6 zones, transformator incl. (chaude/froid & contact circulateur)  
 Regelklemmleiste Plus 6-Zonen, Basic, inkl. Transformator. (Heizung/Kühlung mit Pumpensteuerung)

Article number	Packing	Type
CU-6ZONEP-24V	1 pc.	24V
CU-6ZONEP-230V	1 pc.	230V

### Type: CU-6ZONEK



Base module Comfort 6 zones, transformator (heating/cooling with pump contact and boiler contact)  
 Basismodule Comfort 6 zones, met transformator incl. (verwarmen/koelen met pompsturing en ketelsturing)  
 Module de base Comfort 6 zones, transformateur incl. (chauffer/refroidir avec contact circulateur et contact boiler))  
 Regelklemmleiste 6-Zonen, Komfort, inkl. Transformator (Heizung/Kühlung mit Pumpensteuerung und Boilersteuerung)

Article number	Packing	Type
CU-6ZONEK-24V	1 pc.	24V
CU-6ZONEK-230V	1 pc.	230V

### Type: CU-10ZONEK



Base module Comfort 10 zones, transformator (heating/cooling with pump contact and boiler contact)  
 Basismodule Comfort 10 zones, met transformator incl. (verwarmen/koelen met pompsturing en ketelsturing)  
 Module de base Comfort 10 zones, transformateur incl. (chauffer/refroidir avec contact circulateur et contact boiler))  
 Regelklemmleiste 10-Zonen, Komfort, inkl. Transformator (Heizung/Kühlung mit Pumpensteuerung und Boilersteuerung)

Article number	Packing	Type
CU-10ZONEK-24V	1 pc.	24V
CU-10ZONEK-230V	1 pc.	230V

### Type: CU-DINRAIL



Din rail  
 Din rail  
 Din rail  
 Befestigungsschiene für Regelklemmleiste

Article number	Packing	Type
CU-DINRAIL	1 pc.	



### Type: CU-REGB



Analog thermostat  
Regelaar analoog  
Thermostat analogue  
Raumthermostat, analog

Article number	Packing	Type
CU-REGB-24V	1 pc.	24V
CU-REGB-230V	1 pc.	230V

### Type: CU-REGB-HC



Analog thermostat, heating/cooling  
Regelaar analoog, verwarmen/koelen  
Thermostat analogue, chauffer et refroidir  
Raumthermostat, analog, heizen und kühlen

Article number	Packing	Type
CU-REGB-HC24V	1 pc.	24V
CU-REGB-HC230V	1 pc.	230V

### Type: CU-REGK



LCD comfort thermostat 24V, heating/cooling  
Regelaar LCD comfort, 24V, verwarmen/koelen  
LCD comfort thermostat 24V, chauffer et refroidir  
Raumthermostat, LCD 24V, heizen und kühlen

Article number	Packing	Type
CU-REGK-24V	1 pc.	24V
CU-REGK-230V	1 pc.	230V

### Type: CU-REGC



LCD control thermostat 230V, heating/cooling + clock program  
Regelaar LCD control, 230V, verwarmen/koelen + klokfunctie  
LCD control thermostat 230V, chauffer et refroidir + programmation  
Raumthermostat, LCD, Control, 230V, heizen und kühlen + Zeitsangabe

Article number	Packing	Type
CU-REGC-24V	1 pc.	24V
CU-REGC-230V	1 pc.	230V

### Type: CU-ACT



Act with cable 1m  
Act met vaste kabel 1m  
Act avec cable 1m  
Stellantrieb Kabel 1m

Article number	Packing	Type
CU-ACT-24V	1 pc.	24V
CU-ACT-230V	1 pc.	230V

### Type: CU-ACT-PLUG



Act for plugcable  
Act voor steekbare kabel  
Act pour plugcable  
Stellantrieb für Stecker

Article number	Packing	Type
CU-ACT-24V-PLUG	1 pc.	24V
CU-ACT-230V-PLUG	1 pc.	230V
CU-ACT-B230V	1 pc.	230V

1

2

3

4

5

6

7

8

9

10

11

12



## C. CONTROL UNITS

### 1 Type: CU-PLUGCABLE



Act plugcable  
Losse kabel voor act  
Act plugcable  
Stecker Leitung

Article number	Packing	Type
CU-PLUGCABLE-2M	1 pc.	2 m
CU-PLUGCABLE-5M	1 pc.	5 m
CU-PLUGCABLE-15M	1 pc.	15 m

### 7 Type: UFH-ANC



Valve  
Zoneventiel  
Vanne  
Ventil

Article number	Packing	Type
UFH-ANC-05	1 pc.	2 x 3/4" - M30x1,5 - Kv 2
UFH-ANC-06	1 pc.	2 x 1" - M30x1,5 - Kv 4,5





**WIRELESS CONTROL UNIT (HEATING / COOLING)**

**DRAADLOZE ZONEREGELING (VERWARMEN / KOELEN)**

**RÉGULATEURS DE ZONE SANS FIL (CHAUFFAGE / REFROIDISSEMENT)**

**REGELVERTEILER FUNK (HEIZEN / KÜHLEN)**

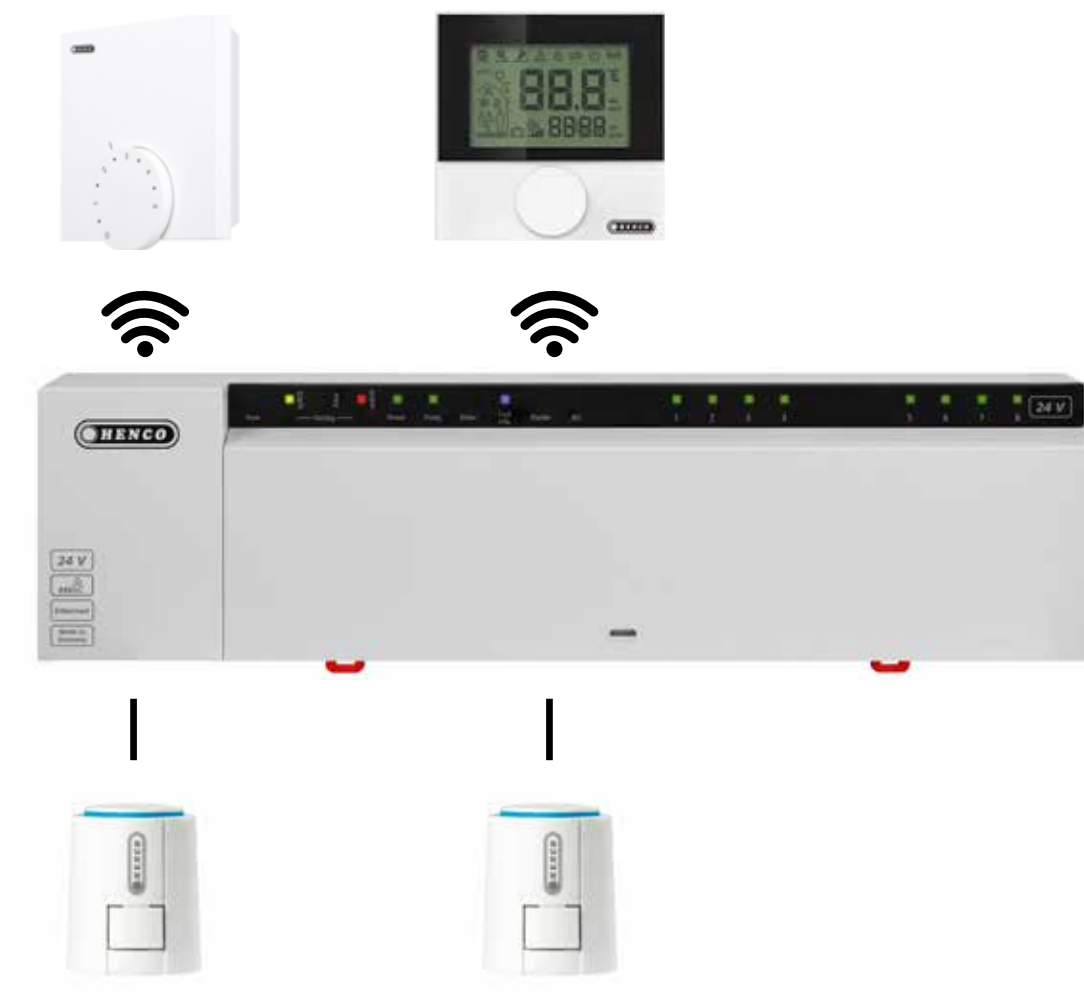

1

2

3

4

5

6

7

8

9

10

11

12



## C. CONTROL UNITS

1

### Type: CU-MONO-RF



One zone module 230V  
Module 1 zone 230V  
Module zone individuelle 230V  
Regelklemmleiste 1-Zone, 230V

Article number	Packing	Type
CU-MONO-RF	1 pc.	

2

3

4

5

6

### Type: CU-8ZONE-RF



Base module 8 zones, 230V LAN DIN rail incl. (heating/cooling)  
Basismodule 8 zones, 230V met LAN en DIN rail (verwarmen/koelen)  
Module de base 8 zones, 230V LAN + DIN rail incl. (chauffer/refroidir)  
Regelklemmleiste 8-Zonen, Funk 230V inkl. Befestigungsschiene (heizen und kühlen)

Article number	Packing	Type
CU-8ZONE-RF	1 pc.	

7

8

9

10

11

### Type: CU-8ZONEB-RF



Base module 8 zones, 230V DIN rail incl. (heating/cooling)  
Basismodule 8 zones, 230V inclusief DIN rail (verwarmen/koelen)  
Module de base 8 zones, 230V DIN rail incl. (chauffer/refroidir)  
Regelklemmleiste 8-Zonen, inkl. Befestigungsschiene (heizen und kühlen)

Article number	Packing	Type
CU-8ZONEB-RF	1 pc.	

12

### Type: CU-12ZONE-RF



Base module 12 zones, 230V LAN din rail incl. (heating/cooling)  
Basismodule 12 zones, 230V met LAN en DIN rail (verwarmen/koelen)  
Module de base 12 zones, 230V LAN + DIN rail incl. (chauffer/refroidir)  
Regelklemmleiste 12-Zonen, Funk 230V inkl. Befestigungsschiene (heizen und kühlen)

Article number	Packing	Type
CU-12ZONE-RF	1 pc.	

### Type: CU-REGB-RF



Analog thermostat, 0-5 incl. batt (heating/cooling)  
Regelaar analog, met instelling 0-5 incl. batt. (verwarmen/koelen)  
Thermostat analogue, 0-5 incl. batt (chauffer/refroidir)  
Raumthermostat analog Funk inkl. Batterie (heizen und kühlen)

Article number	Packing	Type
CU-REGB-RF	1 pc.	



### Type: CU-REGC-RF



Thermostat LCD, optional ext. sensor  
 Regelaar LCD, met aansl. voor ext. sensor  
 Thermostat LCD, option ext. sens  
 Raumthermostat LCD Funk, optional mit externem Sensor

Article number	Packing	Type
CU-REGC-RF	1 pc.	

### Type: CU-REGS-RF



Tamper free sensor  
 Ruimte sensor zonder instelling  
 Sonde sans bouton  
 Raumthermostat 24V, Behördenmodell

Article number	Packing	Type
CU-REGS-RF	1 pc.	

### Type: CU-REPEAT



Repeater  
 Repeater  
 Repeater  
 Repeater

Article number	Packing	Type
CU-REPEAT	1 pc.	

### Type: CU-ANT



Antenne  
 Antenne  
 Antenne  
 Antenne

Article number	Packing	Type
CU-ANT	1 pc.	

### Type: CU-SENS



External sensor  
 Externe sensor  
 Sonde externe  
 Externer Sensor

Article number	Packing	Type
CU-SENS	1 pc.	3 m

1

2

3

4

5

6

7

8

9

10

11

12



## C. CONTROL UNITS

1

### Type: CU-ACT-230V-PLUG

2

3

4

5

6



Act for plugcable, 230V  
Act voor steekbare kabel, 230V  
Act pour plugcable, 230V  
Stellantrieb für Stecker, 230V

Article number	Packing	Type
CU-ACT-230V-PLUG	1 pc.	

7

### Type: CU-PLUGCABLE

8

9

10

11

12



Act plugcable  
Losse kabel voor act  
Act plugcable  
Stecker Leitung

Article number	Packing	Type
CU-PLUGCABLE-2M	1 pc.	2 m
CU-PLUGCABLE-5M	1 pc.	5 m
CU-PLUGCABLE-15M	1 pc.	15 m

### Type: UFH-H5004



Copper shroud for UFH-SENSOR  
Koperen huls voor UFH-SENSOR  
Doigt de gant pour UFH-SENSOR  
Kupferhulse für UFH-SENSOR

Article number	Packing	Type
UFH-H5004	1 pc.	50 mm x 1/2"

### Type: UFH-ANC



Valve  
Zoneventiel  
Vanne  
Ventil

Article number	Packing	Type
UFH-ANC-05	1 pc.	2 x 3/4" - M30x1,5 - Kv 2
UFH-ANC-06	1 pc.	2 x 1" - M30x1,5 - Kv 4,5







1 **Type: UFH-CAB-I**



**Recessed manifold cabinet, RAL 9016**  
**Verdelerkast voor inbouw, RAL 9016**  
**Boîte à encastrer pour collecteurs, RAL 9016**  
**Verteilerschrank Unterputz, RAL 9016**

Article number	Packing	Type
UFH-CAB-I400	1 pc.	400x700-800x112-152mm
UFH-CAB-I600	1 pc.	600x700-800x112-152mm
UFH-CAB-I800	1 pc.	800x700-800x112-152mm
UFH-CAB-I1000	1 pc.	1000x700-800x112-152mm

8 **Type: UFH-CAB-O**



**Surface mount manifold cabinet, RAL 9016**  
**Verdelerkast voor opbouw, RAL 9016**  
**Boîte à poser pour collecteurs, RAL 9016**  
**Verteilerschrank Aufputz, RAL 9016**

Article number	Packing	Type
UFH-CAB-O400	1 pc.	400x720x112mm
UFH-CAB-O600	1 pc.	600x720x112mm
UFH-CAB-O800	1 pc.	800x720x112mm
UFH-CAB-O1000	1 pc.	1000x720x112mm



Press machines, press jaws and calibrating tools should be checked on a regular base when used intensively.

Persmachines, persbekken en kalibreergereedschap dienen bij intensief gebruik op regelmatige basis gecontroleerd te worden.

Des machines à sertir, des pinces et des outils pour calibrage soumis à un usage intensif doivent être contrôlé régulièrement.

Press Maschinen, Pressbacken und Kalibrierung Werkzeuge sollten auf einer regelmäßigen Basis überprüft werden, wenn intensiv genutzt.



### Type: BI

1

2

3

4

5

6



**Internal bending spring**  
**Binnenbuigveer**  
**Ressort à plier intérieur**  
**Biegefeder innen**

Article number	Bag / Box	Type
BI-1410	1 pc. / 100 pc.	14x2 L=50 cm
BI-1612	1 pc. / 100 pc.	16x2 L=50 cm
BI-1612L	1 pc. / 50 pc.	16x2 L=100 cm
BI-1814	1 pc. / 75 pc.	18x2 L=50 cm
BI-2016	1 pc. / 75 pc.	20x2 L=50 cm
BI-2016L	1 pc. / 25 pc.	20x2 L=100 cm
BI-2620	1 pc. / 25 pc.	26x3 L=100 cm

### Type: BA

8

9

10

11

12



**External bending spring**  
**Buitenbuigveer**  
**Ressort à plier extérieur**  
**Biegefeder aussen**

Article number	Bag / Box	Type
BA-1288	1 pc. / 50 pc.	12x1,88 L=50 cm
BA-1410	1 pc. / 50 pc.	14x2 L=50 cm
BA-1612	1 pc. / 50 pc.	16x2 L=50 cm
BA-1814	1 pc. / 50 pc.	18x2 L=50 cm
BA-2016	1 pc. / 50 pc.	20x2 L=50 cm

### Type: BM



**Bending tool**  
**Buigijzer**  
**Cintreuse**  
**Biegewerkzeug**

Article number	Packing	Type
BM-16	1 pc.	for Ø16
BM-18	1 pc.	for Ø18
BM-20	1 pc.	for Ø20
BM-26	1 pc.	for Ø26

### Type: BM-F



**Fast bending tool**  
**Snelbuig tool**  
**Cintreuse rapide**  
**Schnell Biegewerkzeug**

Article number	Packing	Type
BM-16F	1 pc.	for Ø16
BM-20F	1 pc.	for Ø20

### Type: IMPRESS-N



**Guillotine cutter**  
**Guillotineschaar**  
**Pince guillotine**  
**Guillotinezange**

Article number	Packing	Type
IM1426PRESS-N	1 pc.	14 till 26 mm



### Type: IMPRESS



Guillotine cutter mantle pipe cutter in handle  
 Guillotineschaar met mantelbuissnijder in handvat  
 Pince guillotine avec coupe-gaine dans le manche  
 Guillotinezange mit Mantelschneider im Griff

Article number	Packing	Type
IM1426PRESS	1 pc.	14 till 26 mm

### Type: IMEM-PRESS



Replacement blade for IM1426-PRESS(-N)  
 Vervangmes voor IM1426-PRESS(-N)  
 Lame pour IM1426-PRESS(-N)  
 Ersatzmesser für IM1426-PRESS(-N)

Article number	Packing	Type
IMEM1426-PRESS	1 pc.	for IM1426PRESS

### Type: RSEM-PERS



Replacement blade for art. RS1420PRESS and RS2640PRESS  
 Vervangmes voor art. RS1420PRESS en RS2640PRESS  
 Lame pour art. RS1420PRESS et RS2640PRESS  
 Ersatzmesser für Art. RS1420PRESS UND RS2640PRESS

Article number	Packing	Type
RSEM1420-PERS	1 pc.	14 till 20 mm
RSEM2640-PERS	1 pc.	26 till 40 mm

### Type: IM



Wheel cutter  
 Buizensnijder  
 Coupe-tube  
 Rohrschneidezange

Article number	Packing	Type
IM63	1 pc.	14 till 63 mm

### Type: IMEM



Replacement blade for IM 63  
 Vervangsnijwiel voor IM 63  
 Roue de coupe de remplacement pour IM 63  
 Ersatzmesser für IM 63

Article number	Packing	Type
IMEM63	1 pc.	for IMEM63

### Type: RS



Wheel cutter  
 Buizensnijder  
 Coupe-tube  
 Rohrschneidezange

Article number	Packing	Type
RS32	1 pc.	14 till 32 mm

TILL EXHAUSTION OF STOCK



1 **Type: SAFECUT**



Cutter to open the packing paper  
 Mes om verpakkingspapier te openen  
 Couteau pour ouvrir le papier d'emballage  
 Schneider zum Öffnen der Packing

Article number	Packing	Type
SAFECUT	1 pc.	SAFECUT

5 **Type: PS**



Pipe straightener  
 Buizenrechter  
 Redresseur  
 Rohrbegradiger

Article number	Packing	Type
PS-16	1 pc.	Ø16
PS-20	1 pc.	Ø20

10 **Characteristics PS**

- ▶ Simplifies installation and reduces labour
- ▶ Easy to use
- ▶ Less material usage and waste
- ▶ Accelerated flow for better efficiencies and reduced running costs
- ▶ Professional looking finish

**Type: KS-MSET1**



Set with KS-K and KS-M for Ø16, 20 and 26  
 Set met KS-K en KS-M voor Ø16, 20 en 26  
 Set avec KS-K et KS-M pour Ø16, 20 et 26  
 Set mit KS-K und KS-M für Ø16, 20 und 26

Article number	Packing	Type
KS-MSET1	1 pc.	MSET1

**Type: KS-MSET4**



Set with KS-K and KS-M for Ø16, 20, 26 and 32  
 Set met KS-K en KS-M voor Ø16, 20, 26 en 32  
 Set avec KS-K et KS-M pour Ø16, 20, 26 et 32  
 Set mit KS-K und KS-M für Ø16, 20, 26 und 32

Article number	Packing	Type
KS-MSET4	1 pc.	MSET4





### Type: KS



Kalispeed for electric drills (max. 500 rpm, clockwise only)  
 Kalispeed voor accu-boormachine (max. 500 toeren, rechts draaien verplicht)  
 Kalispeed pour perceuses à batterie (max. 500 tournages, obligation de tourner à droite)  
 Kalispeed für Akku-Bohrmaschine (max. 500 Drehungen, rechts drehen verpflichtet)

Article number	Packing	Type
KS50	1 pc.	for Ø50
KS63	1 pc.	for Ø63

### Type: KS-M



Kalispeed, metal, for KS-K and electric drills (max. 500 rpm, clockwise only)  
 Kalispeed, metaal, voor KS-K en accu-boormachine (max. 500 toeren, rechts draaien verplicht)  
 Kalispeed, métal, pour KS-K et perceuses à batterie (max. 500 tours, obligation de tourner à droite)  
 Kalispeed, Metall, für KS-K und Akku-Bohrmaschine (max. 500 Drehungen, rechts drehen verpflichtet)

Article number	Packing	Type
KS12M	1 pc.	for Ø12
KS14M	1 pc.	for Ø14
KS16M	1 pc.	for Ø16
KS18M	1 pc.	for Ø18
KS20M	1 pc.	for Ø20
KS26M	1 pc.	for Ø26
KS32M	1 pc.	for Ø32
KS40M	1 pc.	for Ø40

### Type: KS-K



Clickhandle for KS (Kalispeed)  
 Klikhandvat voor KS (Kalispeed)  
 Manche clic pour KS (Kalispeed)  
 Klickgriff für KS (Kalispeed)

Article number	Packing	Type
KS-K	1 pc.	up to Ø26 mm

### Type: KS-P



Kalispeed for Ø16, 20 and 26  
 Kalispeed voor Ø16, 20 en 26  
 Kalispeed pour Ø16, 20 et 26  
 Kalispeed für Ø16, 20 und 26

Article number	Packing	Type
KS-P162026	1 pc.	for Ø16, 20 and 26

*Not for intensive use*

- 1
- 2
- 3
- 4
- 5
- 6
- 7
- 8
- 9
- 10
- 11
- 12



## Characteristics PH-1632

- ▶ Always sufficient grip when calibrating short pipe ends
- ▶ Prevents the pipe from turning during calibration
- ▶ Inspired by the classic nutcracker model
- ▶ Henco blue anodised aluminium
- ▶ Lightweight tool
- ▶ Suitable for pipe diameters of 16 –20 –26 –32



### Type: PH-1632



Pipe holder for diameters 16-20-26-32  
 Griptang voor buis diameter 16-20-26-32  
 Pince de maintien diamètre 16-20-26-32  
 Rohrhalter für Diameter 16-20-26-32

Article number	Packing	Type
PH-1632	1 pc.	up to 32 mm

### Type: M-BA03



Kit: battery press machine including battery + charge unit + case, linear drive 32 kN, up to Ø 63  
 Kit: accu-persmachine + accu + lader + koffer, lineaire aandrijving 32 kN, tot Ø 63  
 Kit: machine à sertir + batterie + chargeur + coffret, propulsion linéaire 32 kN, jusqu'à Ø 63  
 Kit: Akku-Pressmaschine, lineare Schubkraft 32 kN, bis Ø 63

Article number	Packing	Type
M-BA03	1 pc.	BA03

### Type: M-BAT03



Battery for M-BA03  
 Accu voor M-BA03  
 Batterie pour M-BA03  
 Akku für M-BA03

Article number	Packing	Type
M-BAT03	1 pc.	BAT03

### Type: M-LAD03



Charge-unit for M-BA03, M-BMINI2  
 Lader voor M-BA03, M-BMINI2  
 Chargeur pour M-BA03, M-BMINI2  
 Akku-Ladegerät für M-BA03, M-BMINI2

Article number	Packing	Type
M-LAD03	1 pc.	LAD03



### Type: M-TRANS03



Mains Adapter for M-BA03  
 Adapter voor netaansluiting voor M-BA03  
 Adapteur raccordement au réseau pour M-BA03  
 Netzadapter für M-BA03I

Article number	Packing	Type
M-TRANS03	1 pc.	TRANS03

### Type: M-BOXBA03



Case for M-BA03  
 Koffer voor M-BA03  
 Coffret pour M-BA03  
 Koffer für M-BA03

Article number	Packing	Type
M-BOXBA03	1 pc.	BOX M-BA03

### Type: M-BHY162026



Kit : 230 volt hydraulic press machine with 16, 20, 26 jaws + metal case (110 volt also available), linear drive 32 to 40 kN

Kit : Elektrisch-hydraulische persmachine + bekken 16, 20, 26 + koffer, lineaire aandrijving 32 tot 40kN

Kit : machine à sertir électro-hydraulique + pinces 16, 20, 26 + coffret, propulsion linéaire 32 jusqu'à 40 kN

Kit : Elektrohydraulische Pressmaschine + Pressbacken 16, 20, 26 + Koffer, lineare Schubkraft 32 bis 40 kN

Article number	Packing	Type
M-BHY162026	1 pc.	Ø14-63

- 1
- 2
- 3
- 4
- 5
- 6
- 7
- 8
- 9
- 10
- 11
- 12



1 **Type: M-BHY**



Kit : 230 volt hydraulic press machine + metal case (110 volt also available), linear drive 32 to 40 kN

Kit : Elektrisch-hydraulische persmachine + koffer, lineaire aandrijving 32 tot 40kN  
 Kit: machine à sertir électro-hydraulique + coffret, propulsion linéaire 32 jusqu'à 40 kN

Kit : Elektrohydraulische Pressmaschine + Koffer, lineare Schubkraft 32 bis 40 kN

Article number	Packing	Type
M-BHY	1 pc.	Ø14-63

8 **Type: M-BOXBHY**



Metal case for M-BHY162026

Koffer voor M-BHY162026

Coffret en métal pour M-BHY162026

Koffer für M-BHY162026

Article number	Packing	Type
M-BOXBHY	1 pc.	Ø14-63

10 **Type: BE**



Jaws (universal)

Persbekken (universeel)

Pinces à sertir (universel)

Pressbacken (universal)

Article number	Packing	Type
BE14	1 pc.	BE/TH 14x2
BE16	1 pc.	BE/TH 16x2
BE18	1 pc.	BE/TH 18x2
BE20	1 pc.	BE/TH 20x2
BE26	1 pc.	BE/TH 26x3
BE32	1 pc.	BE 32x3
BE40	1 pc.	BE 40x3,5
BE50	1 pc.	BE 50x4
BE63	1 pc.	BE 63x4,5

*Press tool compatibility: see technical manual*

**Type: BE-UNISSET1**



Set with universal jaw mounting unit and BE-H inserts Ø16, 20 and 26

Set met universele moederbekken en wisselbekken BE-H Ø16, 20, 26

Set avec pince mère universel et pinces BE-H Ø16, 20, 26

Set mit Mutterpressbacke universal und Backen BE-H Ø16, 20, 26

Article number	Packing	Type
BE-UNISSET1	1 pc.	UNISSET1

*Press tool compatibility: see technical manual*



### Type: BE-UNISET2



Set with universal jaw mounting unit and BE-H inserts Ø14, 16, 18, 20, 26, and 32  
 Set met universele moederbek en wisselbekken BE-H Ø14, 16, 18, 20, 26 en 32  
 Set avec pince mère universel et pinces BE-H Ø14, 16, 18, 20, 26, et 32  
 Set mit Mutterpressbacke universal und Backen BE-H Ø14, 16, 18, 20, 26, und 32

Article number	Packing	Type
BE-UNISET2	1 pc.	UNISET2

*Press tool compatibility: see technical manual*

### Type: BE-UNISETMINI3



Set with jaw be-mini3 + be-h inserts ø16,20,26,32  
 set met moederbek be-mini3 en wisselbekken be-h ø16, 20, 26 en 32  
 set avec pince mère be-mini3 + pinces be-h ø16,20,26,32  
 set mit mutterpressbacke be-mini3 + backen be-h ø16,20,26,32

Article number	Packing	Type
BE-UNISETMINI3	1 st.	UNISETMINI3

*Press tool compatibility: see technical manual*

### Type: TOOLBOX16202632



Box with KS16 20 26 32 M, BE-UNI, BE16 20 26 32 H, BI-1612, BI-2016, BA-1612, BA-2016, IM1426PRESS, SAFECUT  
 Koffer met KS16 20 26 32 M, BE-UNI, BE16 20 26 32 H, BI-1612, BI-2016, BA-1612, BA-2016, IM1426PRESS, SAFECUT  
 Coffre avec KS16 20 26 32 M, BE-UNI, BE16 20 26 32 H, BI-1612, BI-2016, BA-1612, BA-2016, IM1426PRESS, SAFECUT  
 Koffer mit KS16 20 26 32 M, BE-UNI, BE16 20 26 32 H, BI-1612, BI-2016, BA-1612, BA-2016, IM1426PRESS, SAFECUT

Article number	Packing	Type
TOOLBOX16202632	1 pc.	TOOLBOX16202632

### Type: TOOLBOX405063



Box with KS40M, KS50, KS63, BE40 50 63, IM63  
 Koffer met KS40M, KS50, KS63, BE40 50 63, IM63  
 Coffre avec KS40M, KS50, KS63, BE40 50 63, IM63  
 Koffer mit KS40M, KS50, KS63, BE40 50 63, IM63

Article number	Packing	Type
TOOLBOX405063	1 pc.	TOOLBOX405063





## 1 Type: BE-UNI



Jaw mounting unit for M-BA03 and M-BHY, to be used with BE-H jaws  
 Moederbek voor M-BA03 en M-BHY en te gebruiken met BE-H bekken  
 Pince mère pour M-BA03 et M-BHY, à utiliser avec pinces BE-H  
 Mutterpressbacke für M-BA03 und M-BHY, zu verwenden mit BE-H Backen

Article number	Packing	Type
BE-UNI	1 pc.	BE-UNI

*Press tool compatibility: see technical manual*

7 BE-UNI is designed to press Henco press fittings, the interchangeable dies with M- and V-profile make it possible to make the transition from other materials to Henco other than Henco branded fittings with compact measurements can cause complex manipulation.

## 9 Type: BE-H



Inserts for BE-UNI, BE-MINI2, BE-MINI3, M-BH  
 Wisselbekken voor BE-UNI, BE-MINI2, BE-MINI3, M-BH  
 Pincés pour BE-UNI, BE-MINI2, BE-MINI3, M-BH  
 Pressbacken für BE-UNI, BE-MINI2, BE-MINI3, M-BH

Article number	Packing	Type
BE14H	1 Set (2 pc.)	BE/TH 14X2 H
BE16H	1 Set (2 pc.)	BE/TH 16X2 H
BE18H	1 Set (2 pc.)	BE/TH 18X2 H
BE20H	1 Set (2 pc.)	BE/TH 20X2 H
BE26H	1 Set (2 pc.)	BE/TH 26X3 H
BE32H	1 Set (2 pc.)	BE 32X3 H

## Type: BE-HC



Inserts (copper) for BE-UNI, BE-MINI2, M-BH, BE-MINI3  
 Wisselbekken (koper) voor BE-UNI, BE-MINI2, M-BH, BE-MINI3  
 Pincés (cuivre) pour BE-UNI, BE-MINI2, M-BH, BE-MINI3  
 Pressbacken (Kupfer) für BE-UNI, BE-MINI2, M-BH, BE-MINI3

Article number	Packing	Type
BE12HC	1 Set (2 pc.)	12Cu V-profile
BE14HC	1 Set (2 pc.)	14Cu V-profile
BE15HC	1 Set (2 pc.)	15Cu V-profile
BE16HC	1 Set (2 pc.)	16Cu V-profile
BE18HC	1 Set (2 pc.)	18Cu V-profile
BE22HC	1 Set (2 pc.)	22Cu V-profile
BE28HC	1 Set (2 pc.)	28Cu V-profile

*Our warranty does not apply to other pipe systems with M or V profile*



### Type: BE-HM



Inserts (copper) for BE-UNI, BE-MINI2, M-BH, BE-MINI3  
 Wisselbekken (koper) voor BE-UNI, BE-MINI2, M-BH, BE-MINI3  
 Pincés (cuivre) pour BE-UNI, BE-MINI2, M-BH, BE-MINI3  
 Pressbacken (Kupfer) für BE-UNI, BE-MINI2, M-BH, BE-MINI3

Article number	Packing	Type
BE12HM	1 Set (2 pc.)	12Cu M-profile
BE15HM	1 Set (2 pc.)	15Cu M-profile
BE18HM	1 Set (2 pc.)	18Cu M-profile
BE22HM	1 Set (2 pc.)	22Cu M-profile

*Our warranty does not apply to other pipe systems with M or V profile*

### Type: BE-BOX



Metal case for 6 compression jaws  
 Stalen koffer voor 6 persbekken  
 Coffret en métal pour 6 pincés à sertir  
 Stahlblechkasten für 6 Pressbacken

Article number	Packing	Type
BE-BOX	1 pc.	BOX

### Type: M-BMINI3-F



Kit : compact rechargeable battery press machine with press monitoring + case + charge unit + battery 18V + full jaws TH16-20-26, linear drive ca. 19 kN  
 Kit: hydraulische accu-persmachine met persbewaking + koffer + lader + 1 accu 18V + volle bekken TH16-20-26, lineaire aandrijving ca. 19kN  
 Kit : machine à sertir hydraulique + boîte + chargeur + batterie 18V, pince TH16-20-26, propulsion linéaire ca.19 kN  
 Kit: Hydraulisches Akku-Presswerkzeug mit Pressdrucküberwachung + Koffer + Ladegerät + 1 Akku 18V + Pressbacken TH16-20-26, lineare Schubkraft ca. 19 kN

Article number	Packing	Type
M-BMINI3-F	1 pc.	Ø16-26 / 18V

### Type: M-BMINI3



Kit : compact rechargeable battery press machine with press monitoring + case + charge unit + battery 18V + mother jaw + inserts TH16-20-26, linear drive ca. 19 kN  
 Kit: hydraulische accu-persmachine met persbewaking + koffer + lader + 1 accu 18V + moederbek met inserts TH16-20-26, lineaire aandrijving ca. 19kN  
 Kit : machine à sertir hydraulique + boîte + chargeur + batterie 18V + pince mère + inserts TH16-20-26, propulsion linéaire ca.19 kN  
 Kit: Hydraulisches Akku-Presswerkzeug mit Pressdrucküberwachung + Koffer + Ladegerät + 1 Akku 18V + Mutterpressbacke und Pressbacken TH16-20-26, lineare Schubkraft ca. 19 kN

Article number	Packing	Type
M-BMINI3	1 pc.	Ø16-26 / 18V



1 **Type: M-BMINI3-S**



Kit : compact rechargeable battery press machine with press monitoring + case + charge unit + battery 18V, linear drive ca. 19 kN  
 Kit: hydraulische accu-persmachine met persbewaking + koffer + lader + 1 accu 18V, lineaire aandrijving ca. 19kN  
 Kit : machine à sertir hydraulique + boîte + chargeur + batterie 18V, propulsion linéaire ca.19 kN  
 Kit: Hydraulisches Akku-Presswerkzeug mit Pressdrucküberwachung + Koffer + Ladegerät + 1 Akku 18V, lineare Schubkraft ca. 19 kN

Article number	Packing	Type
M-BMINI3-S	1 pc.	Ø16-26 / 18V

2  
3  
4  
5  
6  
7  
8 **Type: M-BATMINI3**



Battery 18V for M-BMINI3-F, M-BMINI3, M-BMINI3-S  
 Accu 18V voor M-BMINI3-F, M-BMINI3, M-BMINI3-S  
 Batterie 18V pour M-BMINI3-F, M-BMINI3, M-BMINI3-S  
 Akku 18V für M-BMINI3-F, M-BMINI3, M-BMINI3-S

Article number	Packing	Typ
M-BATMINI3-1.5AH	1 pc.	18V / 1,5 Ah Li-ion
M-BATMINI3-2.0AH	1 pc.	18V / 2,0 Ah Li-ion
M-BATMINI3-3.0AH	1 pc.	18V / 3,0 Ah Li-ion
M-BATMINI3-5.0AH	1 pc.	18V / 3,5 Ah Li-ion

9  
10 **Type: M-LADMINI3**



Charge-unit for M-BMINI3-F, M-BMINI3, M-BMINI3-S  
 Lader voor M-BMINI3-F, M-BMINI3, M-BMINI3-S  
 Chargeur pour M-BMINI3-F, M-BMINI3, M-BMINI3-S  
 Akku-Ladegerät für M-BMINI3-F, M-BMINI3, M-BMINI3-S

Article number	Packing	Type
M-LADMINI3	1 pc.	for M-BATMINI3

11  
12 **Type: M-TRANSMINI3**



Mains Adapter for M-BMINI3-F, M-BMINI3, M-BMINI3-S + 5m cable  
 Adapter voor netaansluiting M-BMINI3-F, M-BMINI3, M-BMINI3-S + 5m kabel  
 Adapteur raccordement au réseau M-BMINI3-F, M-BMINI3, M-BMINI3-S + 5m cable  
 Netzadapter für M-BMINI3-F, M-BMINI3, M-BMINI3-S + 5m Kabel

Article number	Packing	Type
M-TRANSMINI3	1 pc.	18V / 230V



### Type: M-BOXMINI3



Metal case for M-BMINI3, M-BMINI3-S  
 Koffer in metaal voor M-BMINI3, M-BMINI3-S  
 Coffret en métal pour M-BMINI3, M-BMINI3-S  
 Koffer in Metal für M-BMINI3, M-BMINI3-S

Article number	Packing	Type
M-BOXMINI3	1 pc.	M-BOXMINI3

### Type: M-BOXMINI3-F



Metal case for M-BMINI3-F  
 Koffer in metaal voor M-BMINI3-F  
 Coffret en métal pour M-BMINI3-F  
 Koffer in Metal für M-BMINI3-F

Article number	Packing	Type
M-BOXMINI3-F	1 pc.	M-BOXMINI3-F

### Type: BE-MINI3



Mother jaw press machine M-BMINI3 with BE-H inserts  
 Moederbek voor persmachine M-BMINI3 met BE-H inserts  
 Pince mère pour machine à sertir M-BMINI3 avec pinces BE-H  
 Mutterpressbacke für Presswerkzeuge M-BMINI3, zu verwenden mit BE-H backen

Article number	Packing	Type
BE-MINI3	1 pc.	BE-MINI3

### Type: BE..-MINI3



Jaw for press machine M-BMINI3 - TH profile  
 Bek voor persmachine M-BMINI3 - TH profiel  
 Pince pour machine à sertir M-BMINI3 - Profil TH  
 Pressbacke für Presswerkzeuge M-BMINI3 + Profil TH

Article number	Packing	Type
BE14MINI3	1 pc.	BE/TH Ø14
BE16MINI3	1 pc.	BE/TH Ø16
BE20MINI3	1 pc.	BE/TH Ø20
BE26MINI3	1 pc.	BE/TH Ø26
BE32MINI3	1 pc.	BE Ø32

- 1
- 2
- 3
- 4
- 5
- 6
- 7
- 8
- 9
- 10
- 11
- 12



1 **Type: BE.V-MINI3**



Jaw for press machine M-BMINI3 - V profile  
 Bek voor persmachine M-BMINI3 - V profiel  
 Pince pour machine à sertir M-BMINI3 - Profil V  
 Pressbacke für Presswerkzeuge M-BMINI3 + Profil V

Article number	Packing	Type
BE15V-MINI3	1 pc.	V-profile 15mm
BE18V-MINI3	1 pc.	V-profile 18mm
BE22V-MINI3	1 pc.	V-profile 22mm
BE28V-MINI3	1 pc.	V-profile 28mm

*Our warranty does not apply to other pipe systems with M or V profile*

8 **Type: BE.M-MINI3**



Jaw for press machine M-BMINI3 - M profile  
 Bek voor persmachine M-BMINI3 - M profiel  
 Pince pour machine à sertir M-BMINI3 - Profil M  
 Pressbacke für Presswerkzeuge M-BMINI3 + Profil M

Article number	Packing	Type
BE12M-MINI3	1 pc.	M-profile 12mm
BE15M-MINI3	1 pc.	M-profile 15mm
BE18M-MINI3	1 pc.	M-profile 18mm
BE22M-MINI3	1 pc.	M-profile 22mm
BE28M-MINI3	1 pc.	M-profile 28mm

*Our warranty does not apply to other pipe systems with M or V profile*

10 **Type: M-BATMINI2**



Battery 18V / 1,5 Ah Li-ion for M-BMINI2  
 Accu 18V / 1,5 Ah Li-ion voor M-BMINI2  
 Batterie 18V / 1,5 Ah Li-ion pour M-BMINI2  
 Akku 18V / 1,5 Ah Li-ion für M-BMINI2

Article number	Packing	Typ
M-BATMINI2	1 pc.	18V / 1,5 Ah Li-ion

11 **Type: BE.-MINI**



Jaw for press machine M-BMINI2(-S) and M-HP32  
 Bek voor persmachine M-BMINI2(-S) en M-HP32  
 Pince pour machine à sertir M-BMINI2(-S) et M-HP32  
 Pressbacke für Presswerkzeuge M-BMINI2(-S) und M-HP32

Article number	Packing	Type
BE16MINI	1 pc.	BE/TH Ø16
BE20MINI	1 pc.	BE/TH Ø20
BE26MINI	1 pc.	BE/TH Ø26
BE32MINI	1 pc.	BE Ø32

*Not applicable to press machine type M-BMINI3*





### Type: BE..-MMINI



M-profile jaw (copper) for press machine M-BMINI2(-S) and M-HP32  
 M-profiel bek (koper) voor persmachine M-BMINI2(-S) en M-HP32  
 M-profil pince (cuivre) pour machine à sertir M-BMINI2(-S) et M-HP32  
 M-profil Pressbacke (Kupfer) für Presswerkzeuge M-BMINI2(-S) und M-HP32

Article number	Packing	Type
BE15MMINI	1 pc.	Ø15Cu M-Profile
BE22MMINI	1 pc.	Ø22Cu M-Profile

*Not applicable to press machine type M-BMINI3*

### Type: BE-C



V-profile jaw (copper) for press machine M-BMINI2(-S) and M-HP32  
 V-profiel bek (koper) voor persmachine M-BMINI2(-S) en M-HP32  
 V-profil pince (cuivre) pour machine à sertir M-BMINI2(-S) et M-HP32  
 V-profil Pressbacke (Kupfer) für Presswerkzeuge M-BMINI2(-S) und M-HP32

Article number	Packing	Type
BE15C	1 pc.	Ø15Cu V-Profile
BE18C	1 pc.	Ø18Cu V-Profile
BE22C	1 pc.	Ø22Cu V-Profile
BE28C	1 pc.	Ø28Cu V-Profile

*Not applicable to press machine type M-BMINI3*

*Our warranty does not apply to other pipe systems with M or V profile*

### Type: BE-MINI



Jaw mounting unit for press machine M-BMINI2(-S) / M-HP32 and to be used with BE-H jaws  
 Moederbek voor persmachine M-BMINI2(-S) / M-HP32 en te gebruiken met BE-H bekken  
 Pince mère pour machine à sertir M-BMINI2(-S) / M-HP32 et à utiliser avec pinces BE-H  
 Mutterpressbacke für Presswerkzeug M-BMINI2(-S) / M-HP32, zu verwenden mit BE-H Backen

Article number	Packing	Type
BE-MINI	1 pc.	BE-MINI

*BE-MINI is designed to press Henco press fittings, the interchangeable dies with M- and V-profile make it possible to make the transition from other materials to Henco; other than Henco branded fittings with compact measurements can cause complex manipulation*



**Type: BE-H**



Inserts for BE-UNI, BE-MINI, BE-MINI2, BE-MINI3, M-BH  
 Wisselbekken voor BE-UNI, BE-MINI, BE-MINI2, BE-MINI3, M-BH  
 Pincés pour BE-UNI, BE-MINI, BE-MINI2, BE-MINI3, M-BH  
 Pressbacken für BE-UNI, BE-MINI, BE-MINI2, BE-MINI3, M-BH

Article number	Packing	Type
BE14H	1 Set (2 pc.)	BE/TH 14X2 H
BE16H	1 Set (2 pc.)	BE/TH 16X2 H
BE18H	1 Set (2 pc.)	BE/TH 18X2 H
BE20H	1 Set (2 pc.)	BE/TH 20X2 H
BE26H	1 Set (2 pc.)	BE/TH 26X3 H
BE32H	1 Set (2 pc.)	BE 32X3 H

**Type: BE-HC**



Inserts (copper) for BE-UNI, BE-MINI2, M-BH, BE-MINI3  
 Wisselbekken (koper) voor BE-UNI, BE-MINI2, M-BH, BE-MINI3  
 Pincés (cuiivre) pour BE-UNI, BE-MINI2, M-BH, BE-MINI3  
 Pressbacken (Kupfer) für BE-UNI, BE-MINI2, M-BH, BE-MINI3

Article number	Packing	Type
BE12HC	1 Set (2 pc.)	12Cu V-profile
BE14HC	1 Set (2 pc.)	14Cu V-profile
BE15HC	1 Set (2 pc.)	15Cu V-profile
BE16HC	1 Set (2 pc.)	16Cu V-profile
BE18HC	1 Set (2 pc.)	18Cu V-profile
BE22HC	1 Set (2 pc.)	22Cu V-profile
BE28HC	1 Set (2 pc.)	28Cu V-profile

*Our warranty does not apply to other pipe systems with M or V profile*

**Type: BE-HM**



Inserts (copper) for BE-UNI, BE-MINI2, M-BH, BE-MINI3  
 Wisselbekken (koper) voor BE-UNI, BE-MINI2, M-BH, BE-MINI3  
 Pincés (cuiivre) pour BE-UNI, BE-MINI2, M-BH, BE-MINI3  
 Pressbacken (Kupfer) für BE-UNI, BE-MINI2, M-BH, BE-MINI3

Article number	Packing	Type
BE12HM	1 Set (2 pc.)	12Cu M-profile
BE15HM	1 Set (2 pc.)	15Cu M-profile
BE18HM	1 Set (2 pc.)	18Cu M-profile
BE22HM	1 Set (2 pc.)	22Cu M-profile

*Our warranty does not apply to other pipe systems with M or V profile*



### Type: M-HP



Hydraulic manual press tool + bag, exclusive jaws  
 Hydraulisch handpersmachine + draagtas, exclusief bekken  
 Machine à sertir manuelle hydraulique + sac, mâchoires exclusives  
 Hydraulisches Handpressmaschine + Tasche, mit Ausnahme des Beckens

Article number	Packing	Type
M-HP32	1 pc.	Ø14-32

### Type: M-BH



Kit: manual press machine + inserts 16,20,26 + bag  
 Kit: handpersmachine + bekken 16, 20, 26 + draagtas  
 Kit: machine à sertir manuelle + pinces 16, 20, 26 + sac  
 Kit: Handpersmaschine + Pressbacken 16, 20, 26 + Tasche

Article number	Packing	Type
M-BH162026	1 pc.	BH 16x2 / 20x2 / 26x3

*Not for intensive use*

### Type: BE-H



Inserts for BE-UNI, BE-MINI2, BE-MINI3, M-BH  
 Wisselbekken voor BE-UNI, BE-MINI2, BE-MINI3, M-BH  
 Pincés pour BE-UNI, BE-MINI2, BE-MINI3, M-BH  
 Pressbacken für BE-UNI, BE-MINI2, BE-MINI3, M-BH

Article number	Packing	Type
BE14H	1 Set (2 pc.)	BE/TH 14X2 H
BE16H	1 Set (2 pc.)	BE/TH 16X2 H
BE18H	1 Set (2 pc.)	BE/TH 18X2 H
BE20H	1 Set (2 pc.)	BE/TH 20X2 H
BE26H	1 Set (2 pc.)	BE/TH 26X3 H
BE32H	1 Set (2 pc.)	BE 32X3 H

*Our warranty does not apply to other pipe systems with M or V profile*

### Type: BE-HC



Inserts (copper) for BE-UNI, BE-MINI2, M-BH, BE-MINI3  
 Wisselbekken (koper) voor BE-UNI, BE-MINI2, M-BH, BE-MINI3  
 Pincés (cuivre) pour BE-UNI, BE-MINI2, M-BH, BE-MINI3  
 Pressbacken (Kupfer) für BE-UNI, BE-MINI2, M-BH, BE-MINI3

Article number	Packing	Type
BE12HC	1 Set (2 pc.)	12Cu V-profile
BE14HC	1 Set (2 pc.)	14Cu V-profile
BE15HC	1 Set (2 pc.)	15Cu V-profile
BE16HC	1 Set (2 pc.)	16Cu V-profile
BE18HC	1 Set (2 pc.)	18Cu V-profile
BE22HC	1 Set (2 pc.)	22Cu V-profile
BE28HC	1 Set (2 pc.)	28Cu V-profile

*Our warranty does not apply to other pipe systems with M or V profile*



## Type: BE-HM



Inserts (copper) for BE-UNI, BE-MINI2, M-BH, BE-MINI3  
 Wisselbekken (koper) voor BE-UNI, BE-MINI2, M-BH, BE-MINI3  
 Pincas (cuivre) pour BE-UNI, BE-MINI2, M-BH, BE-MINI3  
 Pressbacken (Kupfer) für BE-UNI, BE-MINI2, M-BH, BE-MINI3

Article number	Packing	Type
BE12HM	1 Set (2 pc.)	12Cu M-profile
BE15HM	1 Set (2 pc.)	15Cu M-profile
BE18HM	1 Set (2 pc.)	18Cu M-profile
BE22HM	1 Set (2 pc.)	22Cu M-profile

*Our warranty does not apply to other pipe systems with M or V profile*

## Type: M-BM1620



Kit: manual press machine with 16, 20 jaws  
 Kit: handpersmachine + wisselbekken 16, 20  
 Kit: machine à sertir manuelle + pincas 16, 20  
 Kit: Handpressmaschine + Pressbacken 16, 20

Article number	Packing	Type
M-BM1620	1 pc.	BM 16x2 / 20x2

## Type: BE-M



Inserts for M-BM1620  
 Wisselbekken voor M-BM1620  
 Pincas pour M-BM1620  
 Pressbacken für M-BM1620

Article number	Packing	Type
BE14M	1 Set (2 pc.)	BE 14X2 M
BE16M	1 Set (2 pc.)	BE 16X2 M
BE18M	1 Set (2 pc.)	BE 18X2 M
BE20M	1 Set (2 pc.)	BE 20X2 M

## Type: PRESSCHECK



Tool to control the accuracy of a pressing  
 Instrument om correctheid v/e persing te controleren  
 Outil pour contrôler la précision d'un sertissage  
 Instrument zur Überprüfung ob die Pressung korrekt ausgeführt

Article number	Packing	Type
PRESSCHECK1432	1 pc.	Ø14-32



### Type: DRILLY



Drilly temporary air vent plug, reusable  
 Drilly voor afdrukken leidingsysteem, herbruikbaar  
 Drilly pour tester le système de tubes, réutilisable  
 Drilly zum abdrucken Rohresysteme, wieder verwendbar

Article number	Packing	Type
DRILLY14	1 pc.	Ø14
DRILLY16	1 pc.	Ø16
DRILLY20	1 pc.	Ø20
DRILLY26	1 pc.	Ø26
DRILLY32	1 pc.	Ø32

### Type: PLUG



Plug  
 Afdrukplug  
 Bouchon  
 Stopf

Article number	Packing	Type
PLUG04-B80	20 pc.	1/2" - 80 mm blue
PLUG04-R80	20 pc.	1/2" - 80 mm red
PLUG05-B80	20 pc.	3/4" - 80 mm blue
PLUG05-R80	20 pc.	3/4" - 80 mm red

### Type: UFH-VLA



Decoiler, standard model  
 Haspel, basismodel  
 Machine à dérouler, standard  
 Abwickelmaschine, Standard

Article number	Packing	Type
UFH-VLA	1 pc.	25 m - 600 m

*Minimum inner diameter coil: 140mm*

### Type: UFH-VLA-STR



Pipe straightener for decoiler UFH-VLA 14-26 mm  
 Stangenrechter voor haspel UFH-VLA 14-26 mm  
 Machine à produire des barres pour dérouleur UFH-VLA 14-26 mm  
 Stangenmaschine für Wickelmaschine UFH-VLA 14-26 mm

Article number	Packing	Type
UFH-VLA-STR	1 pc.	

### Type: UFH-VLA-STRHO



Holder for pipe straightener ufh-vla-str 14-26mm  
 Houder voor stangenrechter ufh-vla-str 14-26mm  
 Soutien pour machine à prod. Des barres ufh-vla-str 14-26mm  
 Halter für stangenmaschine ufh-vla-str 14-26mm

Article number	Packing	Type
UFH-VLA-STRHO	1 pc.	Clamp





- 1
- 2
- 3
- 4
- 5
- 6
- 7
- 8
- 9
- 10
- 11
- 12

**Type: UFH-TACK**



Tacker machine for UFH-TACK-40, UFH-TACK-60  
 Tackerapparaat voor UFH-TACK-40, UFH-TACK-60  
 Appareil Tacker pour UFH-TACK-40, UFH-TACK-60  
 Tackergerät für UFH-TACK-40, UFH-TACK-60

Article number	Packing	Type
UFH-TACK	1 pc.	for UFH-TACK-40 / UFH-TACK-60

**Type: UFH-RAS-VLE**



Braid hook  
 Vlechthaak  
 Crochet de tressage  
 Gerät zum Flechten von Stahldraht

Article number	Packing	Type
UFH-RAS-VLE	1 pc.	

**Type: UFH-RAS-CUT**



Cutter for steel mesh  
 Kniptang voor stalen draadmatten  
 Pince coupante pour treillis  
 Schere für Trägermatte

Article number	Packing	Type
UFH-RAS-CUT	1 pc.	

**Type: HNTOOLSET**



Toolset for the Super Sizes range  
 Toolset voor het Super Sizes assortiment  
 Toolset pour la gamme Super Sizes  
 Toolset für das Super Sizes Angebot

Article number	pc	Type
HNTOOLSET	1 pc.	Super Size



## Type: PK-TOOL



Wrench for PK/SK fittings with threading  
 Sleutel voor PK/SK fittings met draad  
 Clé pour raccords PK/SK filtage  
 Schlüssel für PK/SK Fittings mit Draht

Article number	Packing	Type
PK-TOOL04	1 pc.	1/2"
PK-TOOL05	1 pc.	3/4"
PK-TOOL06	1 pc.	1"

## Type: PK-TOOLBOX040506



Set wrenches for PK/SK fittings 1/2" - 1" threading  
 Set sleutels voor PK/SK fittings 1/2" tot 1" draad  
 Set clés pour raccords PK/SK filtage 1/2" - 1"  
 Set Schlüssel für PK/SK Fittings 1/2" bis 1" Draht

Article number	Packing	Type
PK-TOOL-BOX040506	1 pc.	

## Type: PK-TOOLBOX



Empty plastic case for PK-TOOL04/05/06  
 Lege koffer voor PK-TOOL04/05/06  
 Coffret pour PK-TOOL04/05/06  
 Koffer für PK-TOOLBOX04/05/06

Article number	pc	Type
PK-TOOLBOX	1 pc.	

## Characteristics PK-TOOL

- ▶ Light weight ratchet key
- ▶ Full grip around fitting profile
- ▶ Plastic body stays intact, even when applying extreme torque
- ▶ Key works as well in clock- as counterclockwise direction
- ▶ Maximum torque transition
- ▶ Size indication on handle
- ▶ Chromed handle
- ▶ Key gripping jaws in anodized aluminum
- ▶ Possibility to grip around mounted fittings due to specific closing mechanism







### Type: BCLIP



Clip-it clip for Henco pipes, single  
 Clip-it beugel voor Henco buizen, enkel  
 Clip-it attache de fixation pour tubes henco, simple  
 Clip-it Bügel für Henco Rohre, einfach

Article number	Box	Type
BCLIP-16	100 pc.	Ø16
BCLIP-1820	100 pc.	Ø18 - 20
BCLIP-26	100 pc.	Ø26
BCLIP-32 *	100 pc.	Ø32
BCLIP-40 *	100 pc.	Ø40
BCLIP-50 *	50 pc.	Ø50

\* TILL EXHAUSTION OF STOCK

### Type: JCLIP



J-clip pipe clips, single  
 J-clip beugels, enkel  
 Attaches de fixation J-clip, simple  
 J-clip Haken, einfach

Article number	Box	Type
JCLIP-1632	200 pc.	Ø16-32, 70 mm

### Type: JCLIP L



J-clip pipe clips, single  
 J-clip beugels, enkel  
 Attaches de fixation J-clip, simple  
 J-clip Haken, einfach

Article number	Box	Type
JCLIP-1632L	200 pc.	Ø16-32, 97 mm

### Type: JCLIP DOUBLE



J-clip pipe clips, double  
 J-clip beugels, dubbel  
 Attaches de fixation J-clip, double  
 J-clip Haken, doppelt

Article number	Box	Type
JCLIP-1632D	200 pc.	Ø16-32, 70 mm

### Type: JCLIP DOUBLE L



J-clip pipe clips, double  
 J-clip beugels, dubbel  
 Attaches de fixation J-clip, double  
 J-clip Haken, doppelt

Article number	Box	Type
JCLIP-1632DL	200 pc.	Ø16-32, 97 mm

### Type: PIPEPLUG



Protection cap for pipe  
 Beschermstopje voor buis  
 Capuchon de protection pour tube  
 Schutzkappe für Rohr

Article number	Bag / Box	Type
PIPEPLUG16	100 pc. / 700 pc.	Ø 16
PIPEPLUG20	100 pc. / 500 pc.	Ø 20
PIPEPLUG26	100 pc. / 500 pc.	Ø 26



**Type: PLP-P-PK**



**Galvanised bracket for backplate elbow**  
**Gebogen tappuntbeugel gegalvaniseerd**  
**Support galvanisé pour culasse sanitaire**  
**Halteplatte galvanisiert**

Article number	Bag / Box	Type
PLP-P-PK	1 pc. / 30 pc.	

*Interaxis 153mm*

**Type: PLF-P-PK**



**Galvanised bracket flat for backplate elbow**  
**Vlakke tappuntbeugel gegalvaniseerd**  
**Support galvanisé pour culasse sanitaire**  
**Halteplatte flach galvanisiert**

Article number	Bag / Box	Type
PLF-P-PK	1 pc. / 80 pc.	

*Interaxis 120mm and 153mm*

**Type: TESTPLUG**



**Test cap for pipe**  
**Afdicht/test stopje voor buis**  
**Capuchon de test pour tube**  
**Testkappe für Rohr**

Article number	Bag / Box	Type
TESTPLUG16	20 pc. / 4000 pc.	
TESTPLUG20	20 pc. / 2000 pc.	
TESTPLUG26	20 pc. / 2000 pc.	

**Type: AK-EK**



**Adapter from EK 3/4" to flat sealing**  
**Adapter kunststof EK 3/4" naar vlakdichtend**  
**Adaptateur EK 3/4" vers joint plat**  
**Adapter von EK 3/4" nach AG flachdichtend**

Article number	Bag / Box	Type
AK-EK05VD	50 pc. / 1000 pc.	

**Type: REPAIR TAPE**



**Mounting/Repair tape for insulated pipes**  
**Montage-/Reparatietape voor geïsoleerde leidingen**  
**Ruban de montage/Réparation pour les tuyaux isolés**  
**Montage/Reparatur Tape für isolierte Rohre**

Article number	Bag / Box	Type
BDB33M	1 pc.	33 x 50mm
BDR33M	1 pc.	33 x 50mm



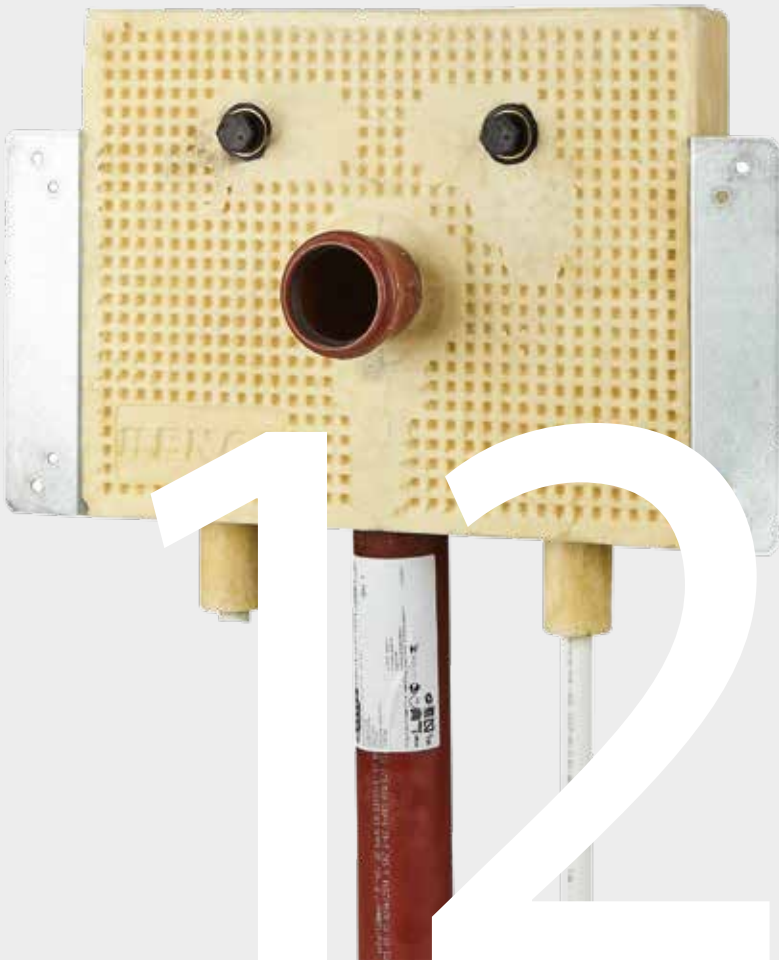

1 2

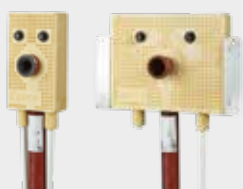

1 **Type: HBOX-GBD**

Bath- and Shower connection, synthetic - Drywall  
 Bad- en douche aansluiting, kunststof - Gipsplaat  
 Raccordement baignoire et douche, synthétique - Cloison sèche  
 Bade- und Duschwannen Anschlüss, kunststoff - Trockenbau

Article number	Type
HBOX-GBD1604	16 X 1/2"
HBOX-GBD2004	20 X 1/2"

2  
3  
4  
5 **Type: HBOX-GBD-3P (CW617)**

Bath- and Shower connection, double backplate - Drywall  
 Bad- en douche aansluiting, doorstroommuurplaat - Gipsplaat  
 Raccordement baignoire et douche, double - Cloison sèche  
 Bade- und Duschwannen Anschlüss, Doppelt - Trockenbau

Article number	Type
HBOX-GBD3P16	16 X 1/2"
HBOX-GBD3P20	20 X 1/2"

6  
7  
8  
9 **Type: HBOX-GWM**

Washing machine connection, synthetic - Drywall  
 Wasmachine aansluiting, kunststof - Gipsplaat  
 Connexion machine à laver, synthétique - Cloison sèche  
 Waschmaschinen Anschlüss, kunststoff - Trockenbau

Article number	Type
HBOX-GWM1604	16 X 1/2"

10  
11  
12 **Type: HBOX-GWM-3P (CW617)**

Washing machine connection, double backplate - Drywall  
 Wasmachine aansluiting, doorstroommuurplaat - Gipsplaat  
 Connexion machine à laver, double - Cloison sèche  
 Waschmaschinen Anschlüss, Doppelt - Trockenbau

Article number	Type
HBOX-GWM3P20	20 X 1/2"

**Type: HBOX-GSP**

Sink connection, synthetic - Drywall  
 Spoeltafel aansluiting, kunststof - Gipsplaat  
 Raccordement d'évier, synthétique - Cloison sèche  
 Spültisch Anschlüss, kunststoff - Trockenbau

Article number	Type
HBOX-GSP1604	16 X 1/2"

**Type: HBOX-GSP-3P (CW617)**

Sink connection, double backplate - Drywall  
 Spoeltafel aansluiting, doorstroommuurplaat - Gipsplaat  
 Raccordement d'évier, double - Cloison sèche  
 Spültisch Anschlüss, Doppelt - Trockenbau

Article number	Type
HBOX-GSP3P16	16 X 1/2"

**Type: HBOX-GWT**

Washbasin connection, synthetic - Drywall  
 Wastafel aansluiting, kunststof - Gipsplaat  
 Raccordement de lavabo, synthétique - Cloison sèche  
 Waschtisch Anschlüss, kunststoff - Trockenbau

Article number	Type
HBOX-GWT16	16 X 1/2"

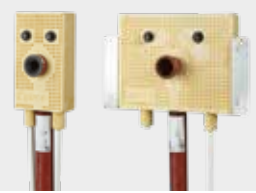

#### Type: HBOX-GWT-3P (CW617)

Washbasin connection, double backplate - Drywall  
Wastafel aansluiting, doorstroommuurplaat - Gipsplaat  
Raccordement de lavabo, double - Cloison sèche  
Waschtisch Anschlüss, Doppelt - Trockenbau

Article number	Type
HBOX-GWT3P16	16 X 1/2"

#### Type: HBOX-GR

Radiator connection - Drywall  
Radiator aansluiting - Gipsplaat  
Connexion radiateur - Cloison sèche  
Heizkörperanschluss - Trockenbau

Article number	Type
HBOX-GR1616	16 X 16

#### Type: HBOX-MSP

Sink connection, synthetic - Masonry  
Spoeltafel aansluiting, kunststof - Metselwerk  
Raccordement d'évier, synthétique - Maçonnerie  
Spültisch Anschlüss, kunststoff - Mauerwerk

Article number	Type
HBOX-MSP1604	16 X 1/2"

#### Type: HBOX-MBD

Bath- and Shower connection, synthetic - Masonry  
Bad- en douche aansluiting, kunststof - Metselwerk  
Raccordement baignoire et douche, synthétique - Maçonnerie  
Bade- und Duschwannen Anschlüss, kunststoff - Mauerwerk

Article number	Type
HBOX-MBD1604	16 X 1/2"
HBOX-MBD2004	20 X 1/2"

#### Type: HBOX-MWM

Washing machine connection, synthetic - Masonry  
Wasmachine aansluiting, kunststof - Metselwerk  
Connexion machine à laver, synthétique - Maçonnerie  
Waschmaschinen Anschlüss, kunststoff - Mauerwerk

Article number	Type
HBOX-MWM1604	16 X 1/2"

#### Type: HBOX-MWT-3P (CW617)

Washbasin connection, double backplate - Masonry  
Wastafel aansluiting, doorstroommuurplaat - Metselwerk  
Raccordement de lavabo, double - Maçonnerie  
Waschtisch Anschlüss, Doppelt - Mauerwerk

Article number	Type
HBOX-MWT3P16	16 X 1/2"

- 1
- 2
- 3
- 4
- 5
- 6
- 7
- 8
- 9
- 10
- 11
- 12

# CERTIFICATES - CERTIFICATEN - APPROBATIONS - ZERTIFIKATE





GERMANY



AUSTRIA



FRANCE



THE NETHERLANDS

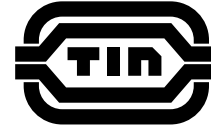

POLAND



DENMARK



ITALY



RUSSIA



SLOVAKIA



ATG SYSTEM CERTIFICATE BELGIUM



NORWAY



FINLAND



HUNGARY



ENGLAND



SWEDEN



USA



ESTONIA



SPAIN



CZECH REPUBLIC



SOUTH AFRICA



# INDEX

Article number	Page	Article number	Page	Article number	Page	Article number	Page
03-160212	8	100-014MBLACK	10	10PK-322032	27	11P-322626	74
03-180214	8	100-014MR	10	10PK-322632	27	11PG-201616	85
03-200216	8	100-016MB	10	10PK-401640	27	11PK-161414	28
03-260320	8	100-016MBLACK	10	10PK-402040	27	11PK-181616	28
03-320326	8	100-016MR	10	10PK-402640	27	11PK-201616	28
03-403533	8	100-018MB	10	10PK-403240	27	11PK-201818	28
03-504042	8	100-018MR	10	10PK-502050	27	11PK-202016	28
03-634554	8	100-020MB	10	10PK-502650	27	11PK-261616	28
03-R160212	12	100-020MR	10	10PK-503250	27	11PK-261620	28
03-R200216	12	100-121688	7	10PK-504050	27	11PK-262016	28
03-R260320	12	100-140210	7	10PK-632663	27	11PK-262020	28
04-160212	8	100-160212	7	10PK-633263	27	11PK-262616	28
04-200216	8	100-180214	7	10PK-634063	27	11PK-262620	28
04-260320	8	100-200216	7	10PK-635063	27	11PK-322026	28
04-320326	8	100-F16R-WZ	16	10PK-753275	27	11PK-322626	28
04-403533	8	100-F20R-WZ	16	10PK-754075	27	11PK-402032	28
04-504042	8	100-ISO4-14-BL	8	10PK-755075	27	11PK-402632	28
04-634554	8	100-ISO4-14-RO	8	10PK-756375	27	11PK-403232	28
04-R160212	12	100-ISO4-16-BL	8	10PK-903290	27	11PK-404026	28
04-R200216	12	100-ISO4-16-RO	8	10PK-904090	27	11PK-404032	28
04-R260320	12	100-ISO4-20-BL	8	10PK-905090	27	11PK-502040	28
05-160212	8	100-ISO4-20-RO	8	10PK-906390	27	11PK-502640	28
05-160212-GAS	20	100-ISO4-R16-BL	13	10PK-907590	27	11PK-503240	28
05-180214	8	100-ISO4-R16-RO	13	10PKG-201620	47	11PK-504040	28
05-200216	8	100-MB	19	10PKG-261626	47	11PK-753232	28
05-200216-GAS	20	100-MBLACK	19	10PKG-262026	47	11PK-753240	28
05-260320	8	100-MG16	19	10PKG-321632	47	11PK-753250	28
05-260320-GAS	20	100-MR	19	10PKG-322032	47	11PK-753263	28
05-320326	8	100-R160212	12	10PKG-322632	47	11PK-753275	28
05-320326-GAS	20	100-R16MB	15	10PKG-401640	47	11PK-754040	28
05-320326-SPR	21	100-R16MBLACK	15	10PKG-402040	47	11PK-754050	28
05-403533	8	100-R16MR	15	10PKG-402640	47	11PK-754063	28
05-403533-GAS	20	100-R180214	12	10PKG-403240	47	11PK-755050	28
05-403533-SPR	21	100-R200216	12	10PKS-322632	51	11PK-755063	28
05-504042	8	100-R20MB	15	10PKS-402640	51	11PK-756363	28
05-504042-SPR	21	100-R20MR	15	10PKS-403240	51	11PK-903232	28
05-634554	8	10P-181618	74	10PKS-503250	51	11PK-903240	28
05-634554-SPR	21	10P-201620	74	10PKS-504050	51	11PK-903250	28
05-756063	8	10P-261626	74	10PKS-633263	51	11PK-903263	28
05-907076	8	10P-262026	74	10PKS-634063	51	11PK-903275	28
05-R160212	12	10P-321632	74	10PKS-635063	51	11PK-903290	28
05-R200216	12	10P-322032	74	10PKW-201620	40	11PK-904040	28
05-R260320	12	10P-322632	74	10PKW-261626	40	11PK-904050	28
1-1604-S	89	10PG-262026	85	10PKW-262026	40	11PK-904063	28
1-1605-S	89	10PK-161416	27	10PKW-321632	40	11PK-904075	28
1-1605-S	89	10PK-16JG1016	27	10PKW-322032	40	11PK-905050	28
1-1804-S	89	10PK-181418	27	10PKW-322632	40	11PK-905063	28
1-1805	89	10PK-181618	27	10SK-201620	65	11PK-905075	28
1-2004-S	89	10PK-201420	27	10SK-261626	65	11PK-906363	28
1-2004-ZS	89	10PK-201620	27	10SK-262026	65	11PK-906375	28
1-2005-S	89	10PK-201820	27	11P-201616	74	11PK-907575	28
1-2605-S	89	10PK-20JG1020	27	11P-202016	74	11PKG-201616	47
1-2606-S	89	10PK-261626	27	11P-261620	74	11PKG-202016	47
1-3206-S	89	10PK-261826	27	11P-262020	74	11PKG-261620	47
10-160212-KB	7	10PK-262026	27	11P-262616	74	11PKG-262016	47
10-1604SN	91	10PK-321632	27	11P-262620	74	11PKG-262020	47
10-R160212-KB	12	10PK-321832	27	11P-322026	74	11PKG-262616	47

Article number	Page	Article number	Page	Article number	Page	Article number	Page
11PKG-262620	47	12SK-162016	66	13PK-751275	29	13PKW-320632-N	42
11PKG-322026	47	12SK-202620	66	13PK-901490	29	13PKW-320632-X	42
11PKG-322626	47	13-1415-2	91	13PKG-160416BP	48	13SK-160416BP	66
11PKG-402032	47	13-1615A-2	91	13PKG-200420BP	48	13SK-200420BP	66
11PKG-402632	47	13-1615HA-2	91	13PKG-200520	48	13SK-200520	66
11PKG-403232	47	13-2022HA-2	91	13PKG-260420BP	48	13SK-260420BP	66
11PKG-404026	47	13-2628H-2	91	13PKG-260426BP	48	13SK-260426BP	66
11PKG-404032	47	13-V2622H-2	91	13PKG-260526	48	13SK-260526	66
11PKS-403232	51	13P-160416	75	13PKG-320532	48	14P-160416	75
11PKS-404032	51	13P-200420	75	13PKG-320632	48	14P-200420	75
11PKS-503240	51	13P-200520	75	13PKG-320732	48	14P-200520	75
11PKS-504040	51	13P-260426	75	13PKG-400640	48	14P-260426	75
11PKW-201616	41	13P-260526	75	13PKG-400740	48	14PK-160416	31
11PKW-202016	41	13P-320532	75	13PKS-320432	52	14PK-180418	31
11PKW-261616	41	13PG-200420	85	13PKS-320432-N	52	14PK-200420	31
11PKW-261620	41	13PG-260426	85	13PKS-320532	52	14PK-200520	31
11PKW-262016	41	13PG-260526	85	13PKS-320532-N	52	14PK-260426	31
11PKW-262020	41	13PK-160416-X	30	13PKS-320632	52	14PK-260526	31
11PKW-262616	41	13PK-160416BP	29	13PKS-320632-N	52	14PK-260626	31
11PKW-262620	41	13PK-180418-X	30	13PKS-320732	52	14PK-320532	31
11PKW-322026	41	13PK-180418BP	29	13PKS-320732-N	52	14PK-400640	31
11PKW-322626	41	13PK-200420-X	30	13PKS-400440	52	14PK-400640-N	31
11SK-201616	66	13PK-200420BP	29	13PKS-400440-N	52	14PK-400740	31
11SK-202016	66	13PK-200520	29	13PKS-400640	52	14PK-400740-N	31
11SK-261620	66	13PK-200520-X	30	13PKS-400640-N	52	14PK-500850	31
11SK-262016	66	13PK-260420-X	30	13PKS-400740	52	14PK-500850-N	31
11SK-262020	66	13PK-260420BP	29	13PKS-400740-N	52	14PK-631063	31
11SK-262616	66	13PK-260426-X	30	13PKS-500450	52	14PK-631063-N	31
11SK-262620	66	13PK-260426BP	29	13PKS-500450-N	52	14PK-751075	31
120-PRT1620	18	13PK-260526	29	13PKS-500550	52	14PK-751275	31
12P-162016	75	13PK-260526-X	30	13PKS-500550-N	52	14PKG-160416	48
12P-202620	75	13PK-320532	29	13PKS-500850	52	14PKG-200420	48
12P-263226	75	13PK-320532-X	30	13PKS-500850-N	52	14PKG-260426	48
12PK-161816	29	13PK-320632	29	13PKS-630463	52	14PKG-260626	48
12PK-162016	29	13PK-320632-X	30	13PKS-630463-N	52	14PKS-320532	53
12PK-202620	29	13PK-320732	29	13PKS-631063	52	14PKS-320532-N	53
12PK-263226	29	13PK-320732-X	30	13PKS-631063-N	52	14PKS-400640	53
12PK-324032	29	13PK-400540	29	13PKW-160416	41	14PKS-400640-N	53
12PK-327532	29	13PK-400540-N	30	13PKW-160416-N	42	14PKS-400740	53
12PK-329032	29	13PK-400540-X	30	13PKW-160416-X	42	14PKS-400740-N	53
12PK-405040	29	13PK-400640	29	13PKW-200420	41	14PKS-500850	53
12PK-407540	29	13PK-400640-N	30	13PKW-200420-N	42	14PKS-500850-N	53
12PK-409040	29	13PK-400640-X	30	13PKW-200420-X	42	14PKS-631063	53
12PK-507550	29	13PK-400740	29	13PKW-200520	41	14PKS-631063-N	53
12PK-509050	29	13PK-400740-N	30	13PKW-200520-N	42	14PKW-160416-N	42
12PK-637563	29	13PK-400740-X	30	13PKW-200520-X	42	14PKW-200420-N	42
12PK-639063	29	13PK-500550	29	13PKW-260426	41	14PKW-200520-N	42
12PK-759075	29	13PK-500550-N	30	13PKW-260426-N	42	14SK-160416	66
12PKG-162016	47	13PK-500550-X	30	13PKW-260426-X	42	14SK-200420	66
12PKG-202620	47	13PK-500850	29	13PKW-260526	41	14SK-260426	66
12PKG-263226	47	13PK-500850-N	30	13PKW-260526-N	42	15-160212-KB	7
12PKG-324032	47	13PK-500850-X	30	13PKW-260526-X	42	15-R160212-KB	12
12PKS-324032	52	13PK-631063	29	13PKW-260526-X	42	15P-1414	75
12PKS-405040	52	13PK-631063-N	30	13PKW-320532	41	15P-1616	75
12PKW-162016	41	13PK-631063-X	30	13PKW-320532-N	42	15P-1818	75
12PKW-202620	41	13PK-750675	29	13PKW-320532-X	42	15P-2020	75
12PKW-263226	41	13PK-751075	29	13PKW-320632	41	15P-2626	75

# INDEX

Article number	Page	Article number	Page	Article number	Page	Article number	Page
15P-3232	75	16PK-6340	32	17PK-1604	33	17SK-2005	67
15PG-1616	86	16PK-6350	32	17PK-1804	33	17SK-2605	67
15PG-2020	86	16PK-7532	32	17PK-1805	33	17SK-2606	67
15PG-2626	86	16PK-7540	32	17PK-2004	33	17SKS-2004	68
15PG-3232	86	16PK-7550	32	17PK-2005	33	17SKS-2004	97
15PK-1414	32	16PK-7563	32	17PK-2605	33	17SKS-2005	68
15PK-1616	32	16PK-9032	32	17PK-2606	33	17SKS-2005	97
15PK-1818	32	16PK-9040	32	17PK-3206	33	17SKS-2604	68
15PK-2020	32	16PK-9050	32	17PK-3207	33	17SKS-2604	97
15PK-2626	32	16PK-9063	32	17PK-4006	33	17SKS-2605	68
15PK-3232	32	16PK-9075	32	17PK-4006-N	33	17SKS-2605	97
15PK-4040	32	16PKG-2016	49	17PK-4007	33	17VBS-2005	104
15PK-5050	32	16PKG-2616	49	17PK-4007-N	33	17VBS-2605	104
15PK-6363	32	16PKG-2620	49	17PK-5008	33	17VBS-2606	104
15PK-7575	32	16PKG-3216	49	17PK-5008-N	33	18EK05-03	98
15PK-9090	32	16PKG-3220	49	17PK-6310	33	18HNA-06	60
15PKG-1616	48	16PKG-3226	49	17PK-6310-N	33	18HNA-06-N	61
15PKG-2020	48	16PKG-4026	49	17PK-7510	33	18HNA-10	60
15PKG-2626	48	16PKG-4032	49	17PK-7512	33	18HNA-10-N	61
15PKG-3232	48	16PKS-4032	53	17PKG-1604	49	18HNA-12	60
15PKG-4040	48	16PKS-5032	53	17PKG-2004	49	18HNA-12-N	61
15PKS-3232	53	16PKS-5040	53	17PKG-2005	49	18HNB-14	60
15PKS-4040	53	16PKS-6340	53	17PKG-2605	49	18HNB-14-N	61
15PKS-5050	53	16PKS-6350	53	17PKG-2606	49	18P-1604	76
15PKS-6363	53	16PKW-2016	43	17PKG-3206	49	18P-1804	76
15SK-1616	67	16PKW-2616	43	17PKG-3207	49	18P-2004	76
15SK-2020	67	16PKW-2620	43	17PKG-4006	49	18P-2005	76
15SK-2626	67	16PKW-3216	43	17PKG-4007	49	18P-2605	76
16HNBA	59	16PKW-3220	43	17PKS-3206	54	18P-2606	76
16P-1614	76	16PKW-3226	43	17PKS-3206-N	54	18P-3206	76
16P-1816	76	16SK-2016	67	17PKS-3207	54	18P-3207	76
16P-2016	76	16SK-2616	67	17PKS-3207-N	54	18PG-1604	87
16P-2018	76	16SK-2620	67	17PKS-4006	54	18PG-2004	87
16P-2616	76	17HNA-10	60	17PKS-4006-N	54	18PG-2005	87
16P-2620	76	17HNA-10-N	60	17PKS-4007	54	18PG-2605	87
16P-3216	76	17HNA-12	60	17PKS-4007-N	54	18PG-2606	87
16P-3220	76	17HNA-12-N	60	17PKS-5008	54	18PG-3206	87
16P-3226	76	17P-1603	76	17PKS-5008-N	54	18PK-1404	34
16PG-2016	86	17P-1603DZR	76	17PKS-6310	54	18PK-1604	34
16PG-2620	86	17P-1604	76	17PKS-6310-N	54	18PK-1604-X	34
16PG-3226	86	17P-1604DZR	76	17PKW-1604	43	18PK-1804	34
16PK-1614	32	17P-1605	76	17PKW-1604-N	43	18PK-1804-X	34
16PK-1814	32	17P-1804	76	17PKW-2004	43	18PK-1805	34
16PK-1816	32	17P-1805	76	17PKW-2004-N	43	18PK-1805-X	34
16PK-2014	32	17P-2004	76	17PKW-2005	43	18PK-2004	34
16PK-2016	32	17P-2005	76	17PKW-2005-N	43	18PK-2004-X	34
16PK-2018	32	17P-2605	76	17PKW-2605	43	18PK-2005	34
16PK-2616	32	17P-2606	76	17PKW-2605-N	43	18PK-2005-X	34
16PK-2618	32	17P-3206	76	17PKW-2606	43	18PK-2605	34
16PK-2620	32	17P-3207	76	17PKW-2606-N	43	18PK-2605-X	34
16PK-3216	32	17PG-1604	86	17PKW-3206	43	18PK-2606	34
16PK-3220	32	17PG-2004	86	17PKW-3206-N	43	18PK-2606-X	34
16PK-3226	32	17PG-2005	86	17PKW-3207	43	18PK-3206	34
16PK-4026	32	17PG-2605	86	17PKW-3207-N	43	18PK-3206-X	34
16PK-4032	32	17PG-2606	86	17SK-1603	67	18PK-3207	34
16PK-5032	32	17PG-3206	86	17SK-1604	67	18PK-3207-X	34
16PK-5040	32	17PK-1404	33	17SK-2004	67	18PK-4006	34

Article number	Page	Article number	Page	Article number	Page	Article number	Page
18PK-4006-N	34	18PKW-3207-N	44	1PK-7575	23	25-200216	7
18PK-4006-X	34	18PKW-3207-X	44	1PK-9090	23	25-200216-GAS	20
18PK-4007	34	18SK-1604	67	1PKG-1616	45	25-200216-KB	7
18PK-4007-N	34	18SK-2004	67	1PKG-2020	45	25-ISO13-32-BL	9
18PK-4007-X	34	18SK-2005	67	1PKG-2626	45	25-ISO13-32-RO	9
18PK-5008	34	18SK-2605	67	1PKG-3232	45	25-ISO20-R26-BL	14
18PK-5008-N	34	18SK-2606	67	1PKG-4040	45	25-ISO20-R26-RO	14
18PK-5008-X	34	18SKS-2004	68	1PKS-3232	50	25-ISO4-26-BL	8
18PK-6310	34	18SKS-2004	97	1PKS-4040	50	25-ISO4-26-RO	8
18PK-6310-N	34	18SKS-2005	68	1PKS-5050	50	25-ISO4-32-BL	8
18PK-6310-X	34	18SKS-2005	97	1PKS-6363	50	25-ISO4-32-RO	8
18PK-7506	34	18SKS-2604	68	1PKW-1616	37	25-ISO4-R16-BL	13
18PK-7510	34	18SKS-2604	97	1PKW-2020	37	25-ISO4-R16-RO	13
18PK-7512	34	18SKS-2605	68	1PKW-2626	37	25-ISO4-R26-BL	13
18PK-9014	34	18SKS-2605	97	1PKW-3232	37	25-ISO4-R26-RO	13
18PKG-1604	49	19P-1405	77	1SK-1616	64	25-ISO9-26-BL	9
18PKG-2004	49	19P-1605	62	1SK-2020	64	25-ISO9-26-RO	9
18PKG-2005	49	19P-1605	77	1SK-2626	64	25-ISO9-32-BL	9
18PKG-2605	49	19P-1805	77	2-1616-S	89	25-ISO9-32-RO	9
18PKG-2606	49	19P-2005	62	2-2020-S	89	25-ISO9-R26-BL	13
18PKG-3206	49	19P-2005	77	200-121688	7	25-ISO9-R26-RO	13
18PKG-3207	49	19PK-1605	35	200-140210	7	25-MB32	19
18PKG-4006	49	19PK-1605	62	200-160212	7	25-MG32	19
18PKG-4007	49	19PK-2005	35	200-180214	7	25-MR32	19
18PKS-3204	54	19PK-2005	62	200-F16R-WZ	16	25-R160212-KB	12
18PKS-3204-N	54	19PKW-1605	44	200-PRT1620	18	25-R16MB	15
18PKS-3206	54	19PKW-2005	44	200-PXC1620	17	25-R16MR	15
18PKS-3206-N	54	19SK-1505	68	200-PXC1720	17	25-R20MB	15
18PKS-3207	54	19SK-1505	96	200-PXC2020	17	25-R20MBLACK	15
18PKS-3207-N	54	19SK-1605	62	200-R160212	12	25-R20MR	15
18PKS-4006	54	19SK-1605	68	200-R180214	12	25P-1604	77
18PKS-4006-N	54	19SK-1605	96	24-1615-S	91	26P-1604	77
18PKS-4007	54	19SK-2005	62	24-2022	91	26P-1605	77
18PKS-4007-N	54	19SK-2005	68	24-2622	91	26P-16Z03	77
18PKS-5008	54	19SK-2005	96	240-PRT1820	18	26P-16Z04	77
18PKS-5008-N	54	1HNA	59	240-PXC1820	17	26P-16Z05	77
18PKS-6310	54	1HNB	59	24P-1604	77	26P-2004	77
18PKS-6310-N	54	1P-1616	72	24P-2004	77	26P-2005	77
18PKW-1604	43	1P-1818	72	25-014MB	10	26P-20Z04	77
18PKW-1604-N	44	1P-2020	72	25-014MR	10	26P-20Z05	77
18PKW-1604-X	44	1P-2626	72	25-016GASMG	20	26P-2605	77
18PKW-2004	43	1P-3232	72	25-016MB	10	26P-2606	77
18PKW-2004-N	44	1PG-1616	84	25-016MB-KB	11	26P-26Z05	77
18PKW-2004-X	44	1PG-2020	84	25-016MR	10	26P-26Z06	77
18PKW-2005	43	1PG-2626	84	25-016MR-KB	11	26P-3206	77
18PKW-2005-N	44	1PG-3232	84	25-020GASMG	20	26P-32Z06	77
18PKW-2005-X	44	1PK-1414	23	25-020MB	10	26P-32Z07	77
18PKW-2605	43	1PK-1616	23	25-020MBLACK	10	26PK-4008	35
18PKW-2605-N	44	1PK-16JG10	23	25-020MR	10	26PK-5010	35
18PKW-2605-X	44	1PK-1818	23	25-026GASMG	20	26PK-6312	35
18PKW-2606	43	1PK-2020	23	25-026MB	10	26PKW-1605	44
18PKW-2606-N	44	1PK-20JG10	23	25-026MR	10	26PKW-2005	44
18PKW-2606-X	44	1PK-2626	23	25-032GASMG	20	26SK-1605	68
18PKW-3206	43	1PK-3232	23	25-032MB	10	26SK-1605	96
18PKW-3206-N	44	1PK-4040	23	25-032MR	10	26SK-2005	68
18PKW-3206-X	44	1PK-5050	23	25-160212-GAS	20	26SK-2005	96
18PKW-3207	43	1PK-6363	23	25-160212-KB	7	27HNA	59

# INDEX

Article number	Page	Article number	Page	Article number	Page	Article number	Page
27HNB	59	2PKG-1603	45	36P-1616P	80	5-1804	90
27P-2626	78	2PKG-1604BP	45	36P-2015P	80	5-2005	90
27P-3232	78	2PKG-1604KBP	45	36P-2018P	80	5-2606	90
27PK-2626	35	2PKG-2004BP	45	36P-2022P	80	50-014MB	10
27PK-3232	35	2PKG-2005	45	36P-2620P	80	50-014MR	10
27PK-4040	35	2PKG-2605	45	36P-2622P	80	50-016GASMG	20
27PK-5050	35	2PKW-1604	37	36P-2628P	80	50-016MB	10
27PK-6363	35	2PKW-1604-N	37	36P-3228P	80	50-016MBLACK	10
27PK-7575	35	2PKW-1604-X	38	36PG-1615P	87	50-016MR	10
27PK-9090	35	2PKW-1604K	37	36PG-2015P	87	50-018MB	10
27PKG-4040	49	2PKW-1604K-N	38	36PG-2022P	87	50-018MR	10
27PKS-3232	55	2PKW-1604K-X	38	36PG-2615P	87	50-020GASMG	20
27PKS-4040	55	2PKW-2004	37	36PG-2622P	87	50-020MB	10
27PKS-5050	55	2PKW-2004-N	37	37P-1412L	81	50-020MBLACK	10
27PKS-6363	55	2PKW-2004-X	37	37P-1612L	81	50-020MR	10
27PKW-2626	44	2PKW-2005	37	37P-1615L	81	50-026GASMG	20
27PKW-3232	44	2PKW-2005-N	37	39P-160450	81	50-026MB	10
28-201620	91	2PKW-2005-X	37	3EK-050405	94	50-026MBLACK	10
28P-14041604-1	78	2PKW-2605	37	3P-160416	72	50-026MR	10
28P-16041604-1	78	2PKW-2605-N	37	3P-160416VK	72	50-160212	7
28PF-16041604	78	2PKW-2605-X	37	3P-200420	72	50-160212-GAS	20
28PF-20042004	78	2S-1604K	64	3P-200420VK	72	50-200216	7
28PK-04	36	2SK-1604BP	64	3P-260426VK	72	50-200216-GAS	20
28PV-16031603-1	78	2SK-2004BP	64	3PK-160416-X	24	50-260320	7
28PV-16041604-1	78	2SK-2005	64	3PK-160416BP	24	50-260320-GAS	20
29P-1612-CS	79	2SK-2605	64	3PK-200420-X	24	50-260320-SPR	21
29P-1615-CS	79	3-1604-S	89	3PK-200420BP	24	50-320326	7
29P-2018-CS	79	3-1804-S	89	3PKW-160416	38	50-320326-GAS	20
29P-2022-CS	79	3-2004-S	89	3PKW-160416-N	39	50-320326-SPR	21
29P-2622-CS	79	3-2005-S	89	3PKW-160416-X	38	50-COMBI16	10
2C-0404	94	3-2605-S	89	3PKW-200420	38	50-COMBI16R	15
2P-1404K	72	3-2606-S	89	3PKW-200420-N	39	50-ISO13-16-BL	9
2P-1604	72	30P-1614S	79	3PKW-200420-X	38	50-ISO13-16-RO	9
2P-1604K	72	30P-1615S-2	79	3SK-160416BP	64	50-ISO13-18-BL	9
2P-1804	72	30P-2022S	79	3SK-200420BP	64	50-ISO13-20-BL	9
2P-2004	72	30P-2622S	79	4-1616-S	89	50-ISO13-20-RO	9
2P-2005	72	30PG-1615S-2	87	4-2020-S	89	50-ISO13-26-BL	9
2P-2605	72	30PG-2022S	87	4-2626-S	89	50-ISO13-26-RO	9
2PG-1604	84	30PG-2622S	87	400-F20R-WZ	16	50-ISO13-R16-BL	13
2PG-1604K	84	31P-161616	79	40P-1615S	81	50-ISO13-R16-RO	13
2PG-2004	84	31P-201616	79	40P-2022S	81	50-ISO13-R20-BL	13
2PG-2005	84	31P-201620	79	40P-2622S	81	50-ISO13-R20-RO	13
2PG-2605	84	31P-202020	79	41P-16	81	50-ISO13-R26-BL	13
2PK-1404-X	23	33P-1605	62	41P-20	81	50-ISO13-R26-RO	13
2PK-1404BP	23	33P-1605	79	41P-26	81	50-ISO20-R16-BL	14
2PK-1603	23	34P-1604	80	41S-20	109	50-ISO20-R16-RO	14
2PK-1604-X	23	34P-1605-CS	80	41S-26	109	50-ISO20-R20-BL	14
2PK-1604BP	23	34P-2004-CS	80	41SKS-20	109	50-ISO20-R20-RO	14
2PK-1604KBP	24	34P-2005-CS	80	41SKS-26	109	50-ISO4-16-BL	8
2PK-1804-X	23	34P-2605-CS	80	42P-161615	82	50-ISO4-16-RO	8
2PK-1804BP	23	34P-3206	80	42P-202019	82	50-ISO4-18-BL	8
2PK-2004-X	23	35P-1615P	80	43P-161516	82	50-ISO4-18-RO	8
2PK-2004BP	23	35P-2022P	80	44P-1604	82	50-ISO4-20-BL	8
2PK-2005	23	35P-3228P	80	45P-1604	82	50-ISO4-20-RO	8
2PK-2005-X	23	36P-1612P	80	4P-1604	73	50-ISO4-26-BL	8
2PK-2605	23	36P-1614P	80	4P-2004	73	50-ISO4-26-RO	8
2PK-2605-X	23	36P-1615P	80	5-1604-S	90	50-ISO4-32-BL	8



Article number	Page	Article number	Page	Article number	Page	Article number	Page
50-ISO4-32-RO	8	50P43-320604	55	5PKS-6310-N	50	6PK-5008-X	26
50-ISO4-COMBI16	9	52P16	82	5PKW-1604	39	6PK-6310	25
50-ISO4-COMBI16R	14	52P20	82	5PKW-1604-N	39	6PK-6310-N	26
50-ISO4-R16-BL	13	52P26	82	5PKW-2004	39	6PK-6310-X	26
50-ISO4-R16-RO	13	52P32	82	5PKW-2004-N	39	6PK-7506	25
50-ISO4-R18-BL	13	52PS32	55	5PKW-2005	39	6PK-7510	25
50-ISO4-R18-RO	13	53PK40	36	5PKW-2005-N	39	6PK-7512	25
50-ISO4-R20-BL	13	53PK50	36	5PKW-2605	39	6PK-9014	25
50-ISO4-R20-RO	13	53PK63	36	5PKW-2605-N	39	6PKG-1604BP	46
50-ISO4-R26-BL	13	53PKS40	55	5PKW-3206	39	6PKG-2004BP	46
50-ISO4-R26-RO	13	53PKS50	55	5PKW-3206-N	39	6PKG-2005	46
50-ISO9-14-BL	9	53PKS63	55	5SK-1604	65	6PKG-2605	46
50-ISO9-14-RO	9	5P-1603	73	5SK-2004	65	6PKG-3206	46
50-ISO9-16-BL	9	5P-1603DZR	73	5SK-2005	65	6PKG-4007	46
50-ISO9-16-RO	9	5P-1604	73	5SK-2605	65	6PKS-3204	50
50-ISO9-18-BL	9	5P-1604DZR	73	6-1604-S	90	6PKS-3204-N	51
50-ISO9-18-RO	9	5P-1804	73	6-1804	90	6PKS-3206	50
50-ISO9-20-BL	9	5P-2004	73	6-2005-S	90	6PKS-3206-N	51
50-ISO9-20-RO	9	5P-2005	73	600-PRT1620	18	6PKS-4004	50
50-ISO9-26-BL	9	5P-2605	73	600-PRT1720	18	6PKS-4004-N	51
50-ISO9-26-RO	9	5P-3206	73	600-PRT1820	18	6PKS-4007	50
50-ISO9-32-BL	9	5PG-1604	84	600-PRT2020	18	6PKS-4007-N	51
50-ISO9-32-RO	9	5PG-2004	84	600-PXC1620	17	6PKS-5004	50
50-ISO9-R16-BL	13	5PG-2005	84	600-PXC1720	17	6PKS-5004-N	51
50-ISO9-R16-RO	13	5PG-2605	84	600-PXC2020	17	6PKS-5007	50
50-ISO9-R18-BL	13	5PK-1404	25	6P-1604	73	6PKS-5007-N	51
50-ISO9-R18-RO	13	5PK-1604	25	6P-1804	73	6PKS-5008	50
50-ISO9-R20-BL	13	5PK-1804	25	6P-2004	73	6PKS-5008-N	51
50-ISO9-R20-RO	13	5PK-2004	25	6P-2005	73	6PKS-6304	50
50-ISO9-R26-BL	13	5PK-2005	25	6P-2605	73	6PKS-6304-N	51
50-ISO9-R26-RO	13	5PK-2605	25	6PG-1604	85	6PKS-6310	50
50-MB20	19	5PK-3206	25	6PG-2004	85	6PKS-6310-N	51
50-MB26	19	5PK-4007	25	6PG-2005	85	6PKW-1603	39
50-MBLACK20	19	5PK-4007-N	25	6PG-2605	85	6PKW-1603-N	40
50-MBLACK26	19	5PK-5007	25	6PK-1404-X	26	6PKW-1604	39
50-MG16	19	5PK-5007-N	25	6PK-1404BP	25	6PKW-1604-N	40
50-MG20	19	5PK-5008	25	6PK-1603	25	6PKW-1604-X	40
50-MG26	19	5PK-5008-N	25	6PK-1604-X	26	6PKW-2004	39
50-MR20	19	5PK-6310	25	6PK-1604BP	25	6PKW-2004-N	40
50-MR26	19	5PK-6310-N	25	6PK-1804-X	26	6PKW-2004-X	40
50-MXC1620	62	5PK-7510	25	6PK-1804BP	25	6PKW-2005	39
50-R160212	12	5PK-7512	25	6PK-2004-X	26	6PKW-2005-N	40
50-R16MB	15	5PKG-1604	46	6PK-2004BP	25	6PKW-2005-X	40
50-R16MBLACK	15	5PKG-2004	46	6PK-2005	25	6PKW-2605	39
50-R16MR	15	5PKG-2005	46	6PK-2005-X	26	6PKW-2605-N	40
50-R18MB	15	5PKG-2605	46	6PK-2605	25	6PKW-2605-X	40
50-R18MR	15	5PKG-3206	46	6PK-2605-X	26	6PKW-3206	39
50-R20MB	15	5PKG-4007	46	6PK-3206	25	6PKW-3206-N	40
50-R20MR	15	5PKS-3206	50	6PK-3206-X	26	6PKW-3206-X	40
50-R260320	12	5PKS-3206-N	50	6PK-4007	25	6SK-1604BP	65
50-R26MB	15	5PKS-4007	50	6PK-4007-N	26	6SK-2004BP	65
50-R26MR	15	5PKS-4007-N	50	6PK-4007-X	26	6SK-2005	65
500-160212D	7	5PKS-5007	50	6PK-5007	25	6SK-2605	65
500-F16R-WZ	16	5PKS-5007-N	50	6PK-5007-N	26	6VBS-2005	104
500-R160212D	12	5PKS-5008	50	6PK-5007-X	26	6VBS-2605	104
50P-3206	55	5PKS-5008-N	50	6PK-5008	25	7-1604-S	90
50P-320604	55	5PKS-6310	50	6PK-5008-N	26	7P-1605	73
50P-320605	55						

# INDEX

Article number	Page	Article number	Page	Article number	Page	Article number	Page
7P-1605K	73	BA-1410	138	BE14M	154	BE26MINI	150
7P-1605L	73	BA-1612	138	BE14MINI3	149	BE26MINI3	149
8-161616-S	90	BA-1814	138	BE15C	151	BE28C	151
8HNA-PK...	62	BA-2016	138	BE15HC	146	BE28HC	146
8HNA-PK32	59	BA-F41	109	BE15HC	152	BE28HC	152
8HNA-PK40	59	BAP-FFV1604	107	BE15HC	153	BE28HC	153
8HNA-PK50	59	BAP-FFV1605EK	107	BE15HM	147	BE28M-MINI3	150
8HNA-PK63	59	BAP-FFV1616	107	BE15HM	152	BE28V-MINI3	150
8HNA-PK75	59	BAP-FFV16Z05	107	BE15HM	154	BE32	144
8HNB-PK90	59	BAP-FFV1805	107	BE15M-MINI3	150	BE32H	146
8P-1604	74	BAP-FFV2005	107	BE15MMINI	151	BE32H	152
9-160416	90	BAP-FFV2005EK	107	BE15V-MINI3	150	BE32H	153
9-200520A	90	BAP-FFV2020	107	BE16	144	BE32MINI	150
9HNA	59	BAP-FFV20Z05	107	BE16H	146	BE32MINI3	149
9HNB	59	BAP-FFV2605	107	BE16H	152	BE40	144
9P-161616	74	BAP-FFV2605EK	107	BE16H	153	BE50	144
9P-181818	74	BAP-FFV2606	107	BE16HC	146	BE63	144
9P-202020	74	BAP-FFV2626	107	BE16HC	152	BI-1410	138
9P-262626	74	BAP-FFV26Z05	107	BE16HC	153	BI-1612	138
9P-323232	74	BAP-FFV26Z06	107	BE16M	154	BI-1612L	138
9PG-161616	85	BAP-FFV3207	107	BE16MINI	150	BI-1814	138
9PG-202020	85	BAP-FFV3232	107	BE16MINI3	149	BI-2016	138
9PG-323232	85	BAP-FFV32Z06	107	BE18	144	BI-2016L	138
9PK-141414	26	BAP-H1616	108	BE18C	151	BI-2620	138
9PK-161616	26	BAP-H2020	108	BE18H	146	BM-16	138
9PK-181818	26	BAP-H2626	108	BE18H	152	BM-16F	138
9PK-202020	26	BAP-H3232	108	BE18H	153	BM-18	138
9PK-262626	26	BAP-SV16105	108	BE18HC	146	BM-20	138
9PK-323232	26	BCLIP-16	159	BE18HC	152	BM-20F	138
9PK-404040	26	BCLIP-1820	159	BE18HC	153	BM-26	138
9PK-505050	26	BCLIP-26	159	BE18HM	147	BP04	24
9PK-636363	26	BCLIP-32	159	BE18HM	152	CU-10ZONEK-230V	128
9PK-757575	26	BCLIP-40	159	BE18HM	154	CU-10ZONEK-24V	128
9PK-909090	26	BCLIP-50	159	BE18M	154	CU-12ZONE-RF	132
9PKG-161616	46	BDB33M	160	BE18M-MINI3	150	CU-6ZONE-230V	128
9PKG-202020	46	BDR33M	160	BE18V-MINI3	150	CU-6ZONE-24V	128
9PKG-262626	46	BE-BOX	147	BE20	144	CU-6ZONEK-230V	128
9PKG-323232	46	BE-MINI	151	BE20H	146	CU-6ZONEK-24V	128
9PKG-404040	46	BE-MINI3	149	BE20H	152	CU-6ZONEP-230V	128
9PKS-323232	51	BE-UNI	146	BE20H	153	CU-6ZONEP-24V	128
9PKS-404040	51	BE-UNISSET1	144	BE20M	154	CU-8ZONE-RF	132
9PKS-505050	51	BE-UNISSET2	145	BE20MINI	150	CU-8ZONEB-RF	132
9PKS-636363	51	BE-UNISSETMINI3	145	BE20MINI3	149	CU-ACT-230V	129
9PKW-161616	40	BE12HC	146	BE22C	151	CU-ACT-230V-PLUG	129
9PKW-202020	40	BE12HC	152	BE22HC	146	CU-ACT-230V-PLUG	134
9PKW-262626	40	BE12HC	153	BE22HC	152	CU-ACT-24V	129
9PKW-323232	40	BE12HM	147	BE22HC	153	CU-ACT-24V-PLUG	129
9SK-161616	65	BE12HM	152	BE22HM	147	CU-ACT-B230V	129
9SK-202020	65	BE12HM	154	BE22HM	152	CU-ANT	133
9SK-262626	65	BE12M-MINI3	150	BE22HM	154	CU-DINRAIL	128
AB1420	92	BE14	144	BE22M-MINI3	150	CU-MONO-RF	132
ABEK04	93	BE14H	146	BE22MMINI	151	CU-PLUGCABLE-15M	130
AD-EKEK	93	BE14H	152	BE22V-MINI3	150	CU-PLUGCABLE-15M	134
AK-EK05VD	160	BE14H	153	BE26	144	CU-PLUGCABLE-2M	130
AN1420	93	BE14HC	146	BE26H	146	CU-PLUGCABLE-2M	134
AT1420	93	BE14HC	152	BE26H	152	CU-PLUGCABLE-5M	130
BA-1288	138	BE14HC	153	BE26H	153	CU-PLUGCABLE-5M	134

Article number	Page	Article number	Page	Article number	Page	Article number	Page
CU-REGB-230V	129	HNTOOLSET	156	PH-1632	142	UFH-0405SLT08	125
CU-REGB-24V	129	IM1426PRESS	139	PIPEPLUG16	159	UFH-0405SLT09	125
CU-REGB-HC230V	129	IM1426PRESS-N	138	PIPEPLUG20	159	UFH-0405SLT10	125
CU-REGB-HC24V	129	IM63	139	PIPEPLUG26	159	UFH-0405SLT11	125
CU-REGB-RF	132	IMEM1426-PRESS	139	PK-TOOL04	157	UFH-0405SLT12	125
CU-REGC-230V	129	IMEM63	139	PK-TOOL05	157	UFH-0405SLT13	125
CU-REGC-24V	129	ISO-BLOCK-S	11	PK-TOOL06	157	UFH-0405SLT14	125
CU-REGC-RF	133	ISO-BOX	79	PK-TOOLBOX	157	UFH-0405SLT15	125
CU-REGK-230V	129	JCLIP-1632	159	PK-TOOLBOX040506	157	UFH-0405SLT16	125
CU-REGK-24V	129	JCLIP-1632D	159	PLF-P-PK	160	UFH-0405SSTE01-PN6	126
CU-REGS-RF	133	JCLIP-1632DL	159	PLP-P-PK	160	UFH-0405SSTE02-PN6	126
CU-REPEAT	133	JCLIP-1632L	159	PLUG04-B80	155	UFH-0405SSTE03-PN6	126
CU-SENS	133	KS-K	141	PLUG04-R80	155	UFH-0405SSTE04-PN6	126
DRILLY14	155	KS-MSET1	140	PLUG05-B80	155	UFH-0405SSTE06-PN6	126
DRILLY16	155	KS-MSET4	140	PLUG05-R80	155	UFH-0405SSTN01-PN6	125
DRILLY20	155	KS-P162026	141	PRESSCHECK1432	154	UFH-0405SSTN02-PN6	125
DRILLY26	155	KS12M	141	PS-16	140	UFH-0405SSTN03-PN6	125
DRILLY32	155	KS14M	141	PS-20	140	UFH-0405SSTN04-PN6	125
EK12-2	92	KS16M	141	RAD04-100V	106	UFH-0405SSTN05-PN6	125
EK14-2	92	KS18M	141	RADNI-0504	108	UFH-0405SSTN06-PN6	125
EK15	106	KS20M	141	RADTH-VL	106	UFH-0505CDP07	124
EK15	92	KS26M	141	RS32	139	UFH-0505CDP08	124
EK16-2	92	KS32M	141	RSEM1420-PERS	139	UFH-0505CDP09	124
EK17-2	92	KS40M	141	RSEM2640-PERS	139	UFH-0505CDP10	124
EK18-2	92	KS50	141	SAFECUT	140	UFH-0505CDP11	124
EK20-2	92	KS63	141	SK-B05	104	UFH-0505CDP12	124
EKH16-2	92	LB50	11	SK-B05	70	UFH-0505CDP13	124
ENDCAP-EK05	99	M-BA03	142	SK-B05	99	UFH-0505CDP14	124
H-0212	102	M-BAT03	142	SK-PIPESTOP16	69	UFH-0505CDP15	124
H-0212-S	102	M-BATMINI2	150	SK-PIPESTOP20	69	UFH-0505CDP16	124
HBOX-GBD1604	162	M-BATMINI3-1.5AH	148	SK-PIPESTOP26	69	UFH-0505SSTE07-PN6	126
HBOX-GBD2004	162	M-BATMINI3-2.0AH	148	SK-STOPCLIP16	69	UFH-0505SSTE08-PN6	126
HBOX-GBD3P16	162	M-BATMINI3-3.0AH	148	SK-STOPCLIP16	99	UFH-0505SSTE09-PN6	126
HBOX-GBD3P20	162	M-BATMINI3-5.0AH	148	SK-STOPCLIP20	69	UFH-0505SSTE10-PN6	126
HBOX-GR1616	163	M-BH162026	153	SK-STOPCLIP20	99	UFH-0505SSTE11-PN6	126
HBOX-GSP1604	162	M-BHY	144	SK-STOPCLIP26	69	UFH-0505SSTE12-PN6	126
HBOX-GSP3P16	162	M-BHY162026	143	SK-STOPCLIP26	99	UFH-0505SSTN07-PN6	125
HBOX-GWM1604	162	M-BM1620	154	SPLIT-S16	92	UFH-0505SSTN08-PN6	125
HBOX-GWM3P20	162	M-BMINI3	147	SPLIT-S20	92	UFH-0505SSTN09-PN6	125
HBOX-GWT16	162	M-BMINI3-F	147	TESTPLUG16	160	UFH-0505SSTN10-PN6	125
HBOX-GWT3P16	163	M-BMINI3-S	148	TESTPLUG20	160	UFH-0505SSTN11-PN6	125
HBOX-MBD1604	163	M-BOXBA03	143	TESTPLUG26	160	UFH-0505SSTN12-PN6	125
HBOX-MBD2004	163	M-BOXBHY	144	TOOLBOX16202632	145	UFH-060502-MD	121
HBOX-MSP1604	163	M-BOXMINI3	149	TOOLBOX405063	145	UFH-060503-MD	121
HBOX-MWM1604	163	M-BOXMINI3-F	149	UFH-0405CDP01	124	UFH-060504-MD	121
HBOX-MWT3P16	163	M-HP32	153	UFH-0405CDP02	124	UFH-060505-MD	121
HN-PEN	60	M-LAD03	142	UFH-0405CDP03	124	UFH-060506-MD	121
HNA	60	M-LADMINI3	148	UFH-0405CDP04	124	UFH-060507-MD	121
HNA-COMP	61	M-TRANS03	143	UFH-0405CDP05	124	UFH-060508-MD	121
HNA-EK05	61	M-TRANSMINI3	148	UFH-0405CDP06	124	UFH-060509-MD	121
HNA-STOP	61	N04	78	UFH-0405SLT01	125	UFH-060510-MD	121
HNA-STOP-E	61	N05	78	UFH-0405SLT02	125	UFH-060511-MD	121
HNA-U	60	N06	78	UFH-0405SLT03	125	UFH-060512-MD	121
HNAFL-DN50	61	P-PIPESTOP16	83	UFH-0405SLT04	125	UFH-0605CD01	124
HNB	60	P-PIPESTOP20	83	UFH-0405SLT05	125	UFH-0605CD02	124
HNB-STOP	61	P-PIPESTOP26	83	UFH-0405SLT06	125	UFH-0605CD03	124
HNB-U	60	P-PIPESTOP32	83	UFH-0405SLT07	125	UFH-0605CD04	124

# INDEX

Article number	Page	Article number	Page	Article number	Page	Article number	Page
UFH-0605CD05	124	UFH-C191800	126	UFH-RAS-BIND15B	112	VBS050504-BL	103
UFH-0605CD06	124	UFH-C191974	126	UFH-RAS-CLIP16	112	VBS050504-RO	103
UFH-0605CD07	124	UFH-C191976	126	UFH-RAS-CLIP18	112	VBS060502-BL	103
UFH-0605CD08	124	UFH-C192071	126	UFH-RAS-CLIP20	112	VBS060502-RO	103
UFH-0605CD09	124	UFH-C260003001	123	UFH-RAS-CUT	156	VBS060503-BL	103
UFH-0605CD10	124	UFH-CAB-I1000	136	UFH-RAS-RB3	112	VBS060503-RO	103
UFH-0605CD11	124	UFH-CAB-I400	136	UFH-RAS-VLE	156	VBS060504-BL	103
UFH-0605CD12	124	UFH-CAB-I600	136	UFH-RAS10	111	VBS060504-RO	103
UFH-0605CD13	124	UFH-CAB-I800	136	UFH-RAS15	111	VDEK-T05	98
UFH-0605CD14	124	UFH-CAB-O1000	136	UFH-RAS20	111	VDSK-20	99
UFH-0605CD15	124	UFH-CAB-O400	136	UFH-SCOTCH-66	113	VDSK-26	99
UFH-0605CD16	124	UFH-CAB-O600	136	UFH-TACK	156	VEK-060502	101
UFH-0605CD17	124	UFH-CAB-O800	136	UFH-TACK-38K	112	VEK-060503	101
UFH-0605CD18	124	UFH-CMDK03	119	UFH-TACK-40	113	VEK-060503-Z	101
UFH-0605CD19	124	UFH-CMDK10	119	UFH-TACK-60	113	VEK-060504	101
UFH-0605CD20	124	UFH-CMDK10	119	UFH-TACK-60	113	VEK-060504-Z	101
UFH-0605MDK02-03L	119	UFH-CMDSS	120	UFH-TACK-KLS20	112	VEK-060505	101
UFH-0605MDK03-03L	119	UFH-CP	124	UFH-TACK-KLS25	112	VEK-060505	101
UFH-0605MDK04-03L	119	UFH-DH40	118	UFH-TACK-KLS30	112	VEK-060505-Z	101
UFH-0605MDK05-03L	119	UFH-DP200	118	UFH-TM050-M	122	VEK-060506-Z	101
UFH-0605MDK06-03L	119	UFH-DRY-1617-150F	113	UFH-UP-12	116	VEK-060507	101
UFH-0605MDK07-03L	119	UFH-DRY-1617-200F	113	UFH-UP-14M1	115	VEK-060507-Z	101
UFH-0605MDK08-03L	119	UFH-DRY-1625-100F	113	UFH-UP-16	116	VEK-060508	101
UFH-0605MDK09-03L	119	UFH-DRY-1625-150F	113	UFH-UP-16M1	115	VEK-060508-Z	101
UFH-0605MDK10-03L	119	UFH-DRY-1625-200F	113	UFH-UP-CUP50	116	VEK-060509-Z	101
UFH-0605MDK11-03L	119	UFH-DRY-1630-150F	113	UFH-VLA	155	VEK-060510-Z	101
UFH-0605MDK12-03L	119	UFH-DRY-B	115	UFH-VLA-STR	155	VISION SET 16	69
UFH-0605MDSS02	120	UFH-DRY-FTAPE	113	UFH-VLA-STRHO	155	VISION SET 20	69
UFH-0605MDSS03	120	UFH-DRY-GLUEF	114	V-050404-Z	101	VISION SET 26	69
UFH-0605MDSS04	120	UFH-DRY-GP100-2	115	V-060402	101	VISION-KEY16	69
UFH-0605MDSS05	120	UFH-DRY-VD100	115	V-060404	101	VISION-KEY20	69
UFH-0605MDSS06	120	UFH-ESK060303-M	122	V-060405	101	VISION-KEY26	69
UFH-0605MDSS07	120	UFH-ESK060303-VN	122	V-060406	101	VS-05	102
UFH-0605MDSS08	120	UFH-FOIL-ALU	116	V-060408	101	VS-0504	102
UFH-0605MDSS09	120	UFH-FOIL-CLIP25	116	VB-EK05	102	VS-06	102
UFH-0605MDSS10	120	UFH-FOIL-N	116	VB-EK05	70	VS-0604	102
UFH-0605MDSS11	120	UFH-FOIL50	116	VB-HANDLE-BLUE	102	VS-0605	102
UFH-0605MDSS12	120	UFH-FOIL90	116	VB-HANDLE-RED	102	VS-07	102
UFH-0605MDSS13	120	UFH-GKT	121	VB050502-BLAUW	103	VS-ENDCAP	98
UFH-0605MDSS14	120	UFH-H5004	134	VB050502-ROOD	103	VS-ENDCAP-M	98
UFH-0605MDSS15	120	UFH-ISOBOARD-GV	117	VB050503-BLAUW	103	VSK-1616	70
UFH-ADN10	118	UFH-ISOBOARD-GVNL	117	VB050503-ROOD	103	VSK-161616	70
UFH-ANC-05	130	UFH-ISOBOARD-S	117	VB050504-BLAUW	103	VSKEK-0502	96
UFH-ANC-05	134	UFH-ISODRY-25	115	VB050504-ROOD	103	VSKEK-0503	96
UFH-ANC-06	130	UFH-ISOPRO11	111	VB060502-BLAUW	103	VVPK-20	99
UFH-ANC-06	134	UFH-ISOPRO30	111	VB060502-ROOD	103	VVPK-26	99
UFH-AO03-MZ	122	UFH-M-D	121	VB060503-BLAUW	103	VVPK90-20-D	100
UFH-B0605-VN	123	UFH-MDK-AO	119	VB060503-ROOD	103	VVPK90-20-U	100
UFH-B0606-M	122	UFH-MDK-CON	119	VB060504-BLAUW	103	VVPK90-26-D	100
UFH-B0606-VN	123	UFH-P18-GP10	114	VB060504-ROOD	103	VVPK90-26-U	100
UFH-BEND1218	118	UFH-P18-GP18	114	VBS-05	104	VVSK-20	96
UFH-BEND20	118	UFH-P18-GP18V	114	VBS-05F	104	VVSK-20-90	97
UFH-BM0606-VN	123	UFH-P18-WN	114	VBS-06	104	VVSK-26	96
UFH-BMH0606-VN	123	UFH-PGKTA	121	VBS-06F	104	VVSK-26-90	97
UFH-BMH0606T-VN	123	UFH-PGKTA-TH	121	VBS050502-BL	103	VVSK-T202020	98
UFH-BS05-M	123	UFH-PLUG80	117	VBS050502-RO	103	VVSK-T20M20	97
UFH-BTM0606-M	122	UFH-PRO	111	VBS050503-BL	103	VVSK-T262626	98
		UFH-RAS-BIND15A	112	VBS050503-RO	103	VVSK-T26M26	97

Article number	Page
WBP-1604-BL	83
WBP-1604-RO	83
WBP-2004-BL	83
WBP-2004-RO	83
WBPL-X	83
WBPL-X	94
WBS-1604-BL	94
WBS-1604-RO	94



WE CARE TO CONNECT



Henco Industries NV | Toekomstlaan 27, 2200 Herentals | Tel. +32 14 28 56 60 | [www.henco.be](http://www.henco.be)

Publication 06/2022

Technische veranderingen en drukfouten voorbehouden

Technical amendments and printing errors reserved

Changements techniques et fautes d'impression sous réserve

Technische Änderungen und Druckfehler vorbehalten